

Rexroth IndraDyn A Asynchronous Motors MAD / MAF

R911295781
Edition 07

Project Planning Manual

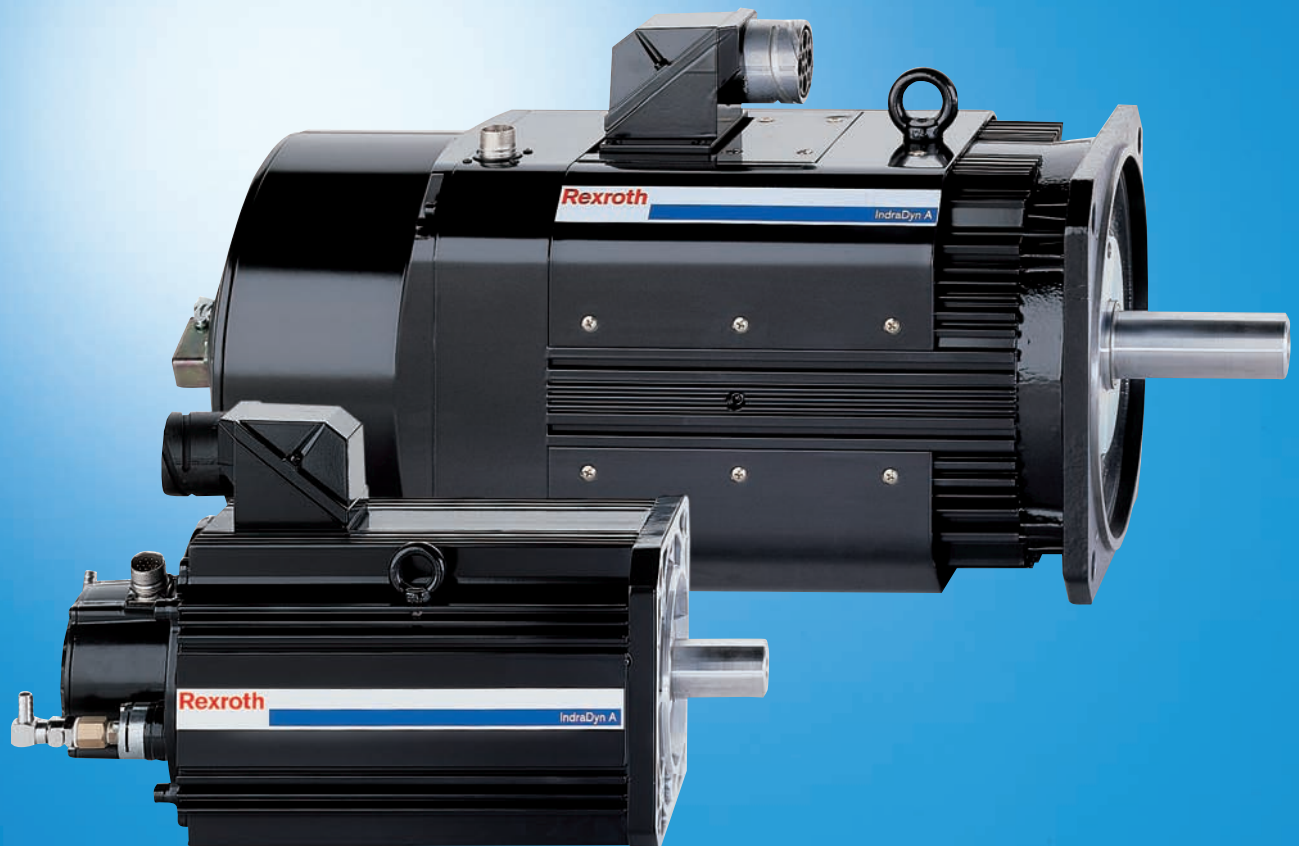

Title	Rexroth IndraDyn A Asynchronous Motors MAD / MAF
Type of Documentation	Project Planning Manual
Document Typecode	DOK-MOTOR*-MAD/MAF****-PR07-EN-P
Internal File Reference	RS-217b481c84cf5c230a6846a001447b0d-5-en-US-7
Purpose of Documentation	This documentation ... <ul style="list-style-type: none"> explains product features and applications, technical data as well as conditions and limits for operation and provides information regarding product selection, handling and operation.

Record of Revision	Edition	Release Date	Notes
	DOK-MOTOR*-MAD/MAF***-PR01-EN-P	09/2003	1.st edition
	DOK-MOTOR*-MAD/MAF***-PR02-EN-P	10/2004	2.nd edition
	DOK-MOTOR*-MAD/MAF***-PR03-EN-P	05/2006	3.rd edition
	DOK-MOTOR*-MAD/MAF***-PR04-EN-P	03/2008	4.th edition
	DOK-MOTOR*-MAD/MAF***-PR05-EN-P	06/2008	5.th edition
	DOK-MOTOR*-MAD/MAF***-PR06-EN-P	08/2008	6.th edition
	DOK-MOTOR*-MAD/MAF***-PR07-EN-P	03/2011	7.th edition

Copyright © Bosch Rexroth AG 2011
Copying this document, giving it to others and the use or communication of the contents thereof without express authority, are forbidden. Offenders are liable for the payment of damages. All rights are reserved in the event of the grant of a patent or the registration of a utility model or design (DIN 34-1).

Validity The specified data is for product description purposes only and may not be deemed to be guaranteed unless expressly confirmed in the contract. All rights are reserved with respect to the content of this documentation and the availability of the product.

Published by Bosch Rexroth AG
Bgm.-Dr.-Nebel-Str. 2 ■ 97816 Lohr a. Main, Germany
Telephone +49 (0)93 52/ 40-0 ■ Fax +49 (0)93 52/ 40-48 85
<http://www.boschrexroth.com/>
Dept. DC-IA/EDM3 (fs)

Note This document has been printed on chlorine-free bleached paper.

Table of Contents

	Page
1 Introduction to the Product.....	9
1.1 General Information.....	9
1.2 About this Documentation.....	10
1.2.1 Document Structure.....	10
1.2.2 Related Documentation.....	10
1.2.3 Additional Components.....	10
1.2.4 Your Feedback.....	11
1.2.5 Standards.....	11
2 Important Instructions on Use.....	13
2.1 Intended Use.....	13
2.1.1 Introduction.....	13
2.1.2 Areas of Use and Application.....	13
2.2 Inappropriate Use	14
3 Safety Instructions for Electric Drives and Controls.....	15
3.1 Definitions of Terms.....	15
3.2 General Information.....	16
3.2.1 Using the Safety Instructions and Passing Them on to Others.....	16
3.2.2 Requirements for Safe Use.....	16
3.2.3 Hazards by Improper Use.....	17
3.3 Instructions with Regard to Specific Dangers.....	19
3.3.1 Protection Against Contact With Electrical Parts and Housings.....	19
3.3.2 Protective Extra-Low Voltage as Protection Against Electric Shock	20
3.3.3 Protection Against Dangerous Movements.....	20
3.3.4 Protection Against Magnetic and Electromagnetic Fields During Operation and Mounting.....	22
3.3.5 Protection Against Contact With Hot Parts.....	22
3.3.6 Protection During Handling and Mounting.....	23
3.3.7 Battery Safety.....	23
3.3.8 Protection Against Pressurized Systems.....	24
3.4 Explanation of Signal Words and the Safety Alert Symbol.....	24
4 Technical Data.....	27
4.1 Operation Modes.....	27
4.1.1 General Information.....	27
4.1.2 Duty Cycle.....	27
4.2 Operating Behavior.....	28
4.2.1 Description of the Parameters Specified.....	28
4.2.2 Example Characteristic Curves.....	30
4.3 Technical Data of MAD100.....	32
4.3.1 Data Sheet of MAD100B.....	32
4.3.2 Motor Characteristic Curves of MAD100B.....	33
4.3.3 Data Sheet of MAD100C.....	36

Table of Contents

	Page	
4.3.4	Motor Characteristic Curves of MAD100C.....	37
4.3.5	Data Sheet of MAD100D.....	40
4.3.6	Motor Characteristic Curves of MAD100D.....	41
4.3.7	Motor Fan MAD100.....	45
4.3.8	Holding Brake MAD/MAF100 (Optional).....	45
4.4	Technical Data of MAD130.....	46
4.4.1	Data Sheet of MAD130B.....	46
4.4.2	Motor Characteristic Curves of MAD130B.....	47
4.4.3	Data Sheet of MAD130C.....	50
4.4.4	Motor Characteristic Curves of MAD130C.....	51
4.4.5	Data Sheet of MAD130D.....	54
4.4.6	Motor Characteristic Curves of MAD130D.....	55
4.4.7	Motor Fan MAD130.....	58
4.4.8	Holding Brake MAD/MAF130 (Optional).....	58
4.5	Technical Data of MAD160.....	59
4.5.1	Data Sheet of MAD160B.....	59
4.5.2	Motor Characteristic Curves of MAD160B.....	60
4.5.3	Data Sheet of MAD160C.....	63
4.5.4	Motor Characteristic Curves of MAD160C.....	64
4.5.5	Motor Fan MAD160.....	67
4.5.6	Holding Brake MAD/MAF160 (Optional).....	67
4.6	Technical Data of MAD180.....	68
4.6.1	Data Sheet of MAD180C.....	68
4.6.2	Motor Characteristic Curves of MAD180C.....	69
4.6.3	Data Sheet of MAD180D.....	72
4.6.4	Motor Characteristic Curves of MAD180D.....	73
4.6.5	Motor Fan MAD180.....	76
4.6.6	Holding Brake MAD/MAF180 (Optional).....	76
4.7	Technical Data of MAD225.....	77
4.7.1	Data Sheet of MAD225C.....	77
4.7.2	Motor Characteristic Curves of MAD225C.....	78
4.7.3	Motor Fan MAD225.....	79
4.8	Technical Data of MAF100.....	80
4.8.1	Data Sheet of MAF100B.....	80
4.8.2	Motor Characteristic Curves of MAF100B.....	81
4.8.3	Data Sheet of MAF100C.....	84
4.8.4	Motor Characteristic Curves of MAF100C.....	85
4.8.5	Data Sheet of MAF100D.....	88
4.8.6	Motor Characteristic Curves of MAF100D.....	89
4.8.7	Holding Brake MAD/MAF100 (Optional).....	92
4.9	Technical Data of MAF130.....	94
4.9.1	Data Sheet of MAF130B.....	94
4.9.2	Motor Characteristic Curves of MAF130B.....	95
4.9.3	Data Sheet of MAF130C.....	98
4.9.4	Motor Characteristic Curves of MAF130C.....	99
4.9.5	Data Sheet of MAF130D.....	102

Table of Contents

	Page	
4.9.6	Motor Characteristic Curves of MAF130D.....	103
4.9.7	Holding Brake MAD/MAF130 (Optional).....	106
4.10	Technical Data of MAF160.....	108
4.10.1	Data Sheet of MAF160B.....	108
4.10.2	Motor Characteristic Curves of MAF160B.....	109
4.10.3	Data Sheet of MAF160C.....	112
4.10.4	Motor Characteristic Curves of MAF160C.....	113
4.10.5	Holding Brake MAD/MAF160 (Optional).....	115
4.11	Technical Data of MAF180.....	116
4.11.1	Data Sheet of MAF180C.....	116
4.11.2	Motor Characteristic Curves of MAF180C.....	117
4.11.3	Data Sheet of MAF180D.....	120
4.11.4	Motor Characteristic Curves of MAF180D.....	121
4.11.5	Holding Brake MAD/MAF180 (Optional).....	123
4.12	Technical Data of MAF225.....	124
4.12.1	Data Sheet MAF225C.....	124
4.12.2	Motor Characteristic Curves of MAF225C.....	125
5	Dimension Drawings IndraDyn A.....	127
5.1	Frame Size MAD100.....	127
5.1.1	MAD100 without Brake.....	127
5.1.2	MAD100 with Brake 1 or 5.....	128
5.1.3	MAD100 with Fan Shroud, without Brake.....	129
5.1.4	MAD100 with Fan Shroud, Brake 1 or 5.....	130
5.1.5	MAD100 in Ex-type Design with M6 or S6 Encoder, without Brake	131
5.1.6	MAD100 in Ex-type Design with M6 or S6 Encoder, Brake 1 or 5.....	132
5.2	Frame Size MAD130.....	133
5.2.1	MAD130 without Brake.....	133
5.2.2	MAD130 with Brake 1 or 5.....	134
5.2.3	MAD130 with Fan Shroud, without Brake.....	135
5.2.4	MAD130 with Fan Shroud, Brake 1 or 5.....	136
5.2.5	MAD130 in Ex-type Design with M6 or S6 Encoder, without Brake	137
5.2.6	MAD130 in Ex-type Design with M6 or S6 Encoder, Brake 1 or 5.....	138
5.3	Frame Size MAD160.....	139
5.3.1	MAD160 without Brake.....	139
5.3.2	MAD160 with Brake 1 or 5.....	140
5.3.3	MAD160 with Brake 3.....	141
5.3.4	MAD160 with Fan Shroud, without Brake.....	142
5.3.5	MAD160 with Fan Shroud, Brake 1 or 5.....	143
5.3.6	MAD160 with Fan Shroud and Brake 3.....	144
5.3.7	MAD160 in Ex-type Design with M6 or S6 Encoder, without Brake	145
5.3.8	MAD160 in Ex-type Design with M6 or S6 Encoder, Brake 1 or 5.....	146
5.3.9	MAD160 in Ex-type Design with M6 or S6 Encoder, Brake 3.....	147
5.4	Frame Size MAD180.....	148
5.4.1	MAD180 without Brake.....	148
5.4.2	MAD180 with Brake 2 or 5.....	149

Table of Contents

	Page
5.4.3	MAD180 with Fan Shroud, without Brake..... 150
5.4.4	MAD180 with Fan Shroud, Brake 2 or 5..... 151
5.4.5	MAD180 in Ex-type Design with M6 or S6 Encoder, without Brake 152
5.4.6	MAD180 in Ex-type Design with M6 or S6 Encoder, Brake 2 or 5..... 153
5.5	Frame Size MAD225..... 154
5.5.1	MAD225 without Brake..... 154
5.5.2	MAD225 with Fan Shroud, without Brake..... 155
5.5.3	MAD225 in Ex-type Design, M6 or S6 Encoder, without Brake 156
5.6	Frame Size MAF100..... 157
5.6.1	MAF100 without Brake..... 157
5.6.2	MAF100 with Brake 1 or 5..... 158
5.6.3	MAF100 in Ex-type Design with M6 or S6 Encoder, without Brake 159
5.6.4	MAF100 in Ex-type Design with M6 or S6 Encoder, Brake 1 or 5..... 160
5.7	Frame Size MAF130..... 161
5.7.1	MAF130 without Brake..... 161
5.7.2	MAF130 with Brake 1 or 5..... 162
5.7.3	MAF130 in Ex-type Design with M6 or S6 Encoder, without Brake 163
5.7.4	MAF130 in Ex-type Design with M6 or S6 Encoder, Brake 1 or 5..... 164
5.8	Frame Size MAF160..... 165
5.8.1	MAF160 without Brake..... 165
5.8.2	MAF160 with Brake 1 or 5..... 166
5.8.3	MAF160 in Ex-type Design with M6 or S6 Encoder, without Brake 167
5.8.4	MAF160 in Ex-type Design with M6 or S6 Encoder, Brake 1 or 5..... 168
5.9	Frame Size MAF180..... 169
5.9.1	Threaded Holes in MAF180 Motor Housing..... 169
5.9.2	MAF180 without Brake..... 170
5.9.3	MAF180 with Brake 2 or 5..... 171
5.9.4	MAF180 in Ex-type Design with M6 or S6 Encoder, without Brake 172
5.9.5	MAF180 in Ex-type Design with M6 or S6 Encoder, Brake 2 or 5..... 173
5.10	Frame Size MAF225..... 174
5.10.1	Threaded Holes in MAF225 Motor Housing..... 174
5.10.2	MAF225C without Brake..... 175
5.10.3	MAF225 in Ex-type Design with M6 or S6 Encoder, without Brake 176
6	Type Codes IndraDyn A..... 177
6.1	Introduction..... 177
6.1.1	General Information..... 177
6.1.2	Definition..... 177
	1. Product..... 177
	2. Motor Frame Size..... 177
	3. Motor Frame Length..... 177
	4. Winding Code 177
	5. Cooling Type 177
	6. Motor Encoder..... 179
	7. Electrical Connection..... 179
	8. Output Shaft 180

Table of Contents

	Page
9. Holding Brake	180
10. Frame Shape.....	180
11. Bearing.....	180
12. Oscillating Quantity Level.....	181
6.2 Type Code MAD100.....	182
6.3 Type Code MAD130.....	184
6.4 Type Code MAD160.....	186
6.5 Type Code MAD180.....	188
6.6 Type Code MAD225.....	190
6.7 Type Code MAF100.....	192
6.8 Type Code MAF130.....	194
6.9 Type Code MAF160.....	196
6.10 Type Code MAF180.....	198
6.11 Type Code MAF225.....	200
7 Accessories.....	203
7.1 Sealing Air Connection.....	203
7.2 Gearboxes	205
7.3 Order Designations for Thread Reducing Fittings on the Terminal Box.....	205
8 Connection Methods.....	207
8.1 Notes.....	207
8.2 Power Connection	208
8.2.1 General Information.....	208
8.2.2 Additional Ground Conductor on Motors.....	208
8.3 Power Connection with Flange Socket.....	208
8.3.1 Motors with Flange Socket.....	208
8.3.2 Connection Diagram.....	209
8.4 Power Connection with Terminal Box.....	209
8.4.1 Overview of Motors with Terminal Box.....	209
8.4.2 Cable Connecting Thread on Terminal Box.....	209
8.4.3 Connection Diagram.....	211
8.4.4 Terminal Box Details.....	212
8.4.5 Power Connection.....	212
8.5 Double Cabling.....	214
8.6 Encoder Connection	216
8.7 Temperature Sensor	218
8.8 Holding Brake	218
8.9 Motor Cooling.....	218
8.9.1 Fan Connection.....	218
8.9.2 Coolant Port	219
8.9.3 Coolant Input Pressure	222
9 Application Guidelines	223
9.1 Operating Conditions	223

Table of Contents

	Page	
9.1.1	Installation Altitude and Ambient Air Temperature.....	223
9.2	Humidity.....	224
9.3	Vibration and Shock.....	224
9.3.1	Vibration.....	224
9.3.2	Shock.....	225
9.4	Compatibility Test.....	225
9.5	Degree of Protection.....	226
9.6	Frame Shape and Installation Position	227
9.6.1	General Information.....	227
9.6.2	Foot Assembly.....	228
9.6.3	Vertical Installation Positions.....	229
9.7	Motor Paint.....	229
9.8	Motor Cooling.....	230
9.8.1	Fan.....	230
9.8.2	Radial Ventilation in Heavily Soiled or Potentially Explosive Atmospheres.....	232
9.8.3	Coolant	234
9.8.4	Coolant Additives.....	235
9.8.5	Materials Used.....	236
9.8.6	Coolant Supply Temperature	237
9.9	Motor Temperature Monitoring.....	237
9.10	Holding Brake (Optional).....	238
9.10.1	General Information.....	238
9.10.2	Holding Brakes - Notes Regarding Safety.....	239
9.10.3	Selecting Holding Brakes.....	240
	General Information.....	240
	Main Spindle Applications.....	240
	Servo Applications.....	240
9.10.4	Layout of Holding Brakes.....	241
9.11	Motor Encoder	242
9.11.1	Options.....	242
9.11.2	Compatibility	242
9.11.3	Accuracy.....	242
9.11.4	Encoder Connection.....	243
9.12	Output Shaft	244
9.12.1	Plain Shaft.....	244
9.12.2	Output Shaft with Keyway.....	244
9.12.3	Output Shaft with Shaft Sealing Ring.....	245
9.12.4	Output Shaft with Labyrinth Seal.....	246
9.13	Bearing Variants and Shaft Load.....	247
9.13.1	Bearing Variants.....	247
9.13.2	Selection Tips.....	249
9.13.3	Radial Load, Axial Load.....	249
9.14	Attaching Drive Elements.....	257
9.14.1	General Information.....	257
9.14.2	Gearboxes.....	258
9.14.3	Couplings.....	258

Table of Contents

	Page
9.14.4 Skew Bevel Driving Pinions.....	259
9.14.5 Bevel Gear Pinions.....	259
9.15 Bearing Service Life.....	260
9.16 Grease Service Life.....	261
9.17 Oscillating Quantity Level.....	265
9.18 Explosion Protection.....	268
9.18.1 Motors in Ex-px d Design (Type Code Option "M6" or "S6").....	268
9.19 Acceptances and Approvals.....	269
9.19.1 CE Mark.....	269
9.19.2 UR/cUR Listing.....	269
10 Handling and Transport.....	271
10.1 Condition on Delivery	271
10.1.1 General Information.....	271
10.1.2 Factory Test	271
10.1.3 Test Performed by the Customer	271
10.2 Identification.....	271
10.3 Labeling.....	272
10.4 Transport and Storage.....	273
10.4.1 General Information.....	273
10.4.2 Transport-related Guidelines.....	273
10.4.3 Storage-related Guidelines.....	275
.....	275
11 Installation.....	277
11.1 Safety.....	277
11.2 Mechanical Attachment.....	277
11.2.1 Motor Attachment.....	277
11.2.2 Preparing Assembly.....	279
11.2.3 Assembling the Motor.....	279
11.3 Electrical Connection	280
11.3.1 General Information.....	280
11.3.2 Additional Ground Conductor on Motors.....	280
12 Operating of IndraDyn A Motors.....	281
12.1 Commissioning.....	281
12.1.1 General Information.....	281
12.1.2 Preparation.....	281
12.1.3 Steps Required.....	281
12.2 Shutdown.....	282
12.3 Disassembly.....	282
12.4 Maintenance.....	283
12.4.1 General Information.....	283
12.4.2 Measures.....	283
12.4.3 Motor Fan	283

Table of Contents

	Page
General Information.....	283
General fan maintenance steps:.....	285
12.4.4 Coolant Supply	286
12.4.5 Servicing and Commissioning Holding Brakes	286
12.5 Troubleshooting	287
12.5.1 General Information.....	287
12.5.2 Temperature on Motor Housing too High.....	288
12.5.3 High Motor Temperature Values, but Normal Housing Temperature.....	288
12.5.4 Motor or Machine Table Generates Vibrations.....	288
12.5.5 Specified Position Is not Reached.....	289
12.6 Environmental Protection and Disposal	289
12.6.1 Environmental Protection.....	289
12.6.2 Disposal.....	290
13 Motors for Potentially Explosive Atmospheres.....	291
13.1 General Information on Motors in Ex-px d Design (Type Code Option "M6" / "S6").....	291
13.1.1 Introduction.....	291
13.1.2 Device Group / Device Categories.....	292
13.1.3 Zones of Potentially Explosive Atmospheres	292
13.1.4 Device Groups, Ignition Protection Types and Temperature Classes.....	293
13.2 Appropriate Use.....	294
13.3 Conditions of Use	295
13.3.1 General Information.....	295
13.3.2 Internal Motor Brake (Optional).....	296
13.4 Residual Risks.....	297
13.5 Selecting and Labeling Ex-type Motors	297
13.6 Additional Components	299
13.6.1 General Information.....	299
13.6.2 Motor Fan.....	299
13.6.3 Ex-p Control Unit for Motor Purging.....	300
13.6.4 Connecting Cables.....	301
13.7 Installing, Commissioning, Servicing and Dismounting Ex-type Motors.....	301
14 Service and Support.....	303
Index.....	305

1 Introduction to the Product

1.1 General Information

The Rexroth **IndraDyn A** motor generation consists of asynchronous box motors with squirrel-cage rotor and it is available as

- **MAD series** with surface cooling by permanently connected fan units.



Fig. 1-1: Example MAD130

- **MAF series** with liquid cooling



Fig. 1-2: Example MAF100

With their high continuous ratings and compact dimensions, IndraDyn A motors can be used as main and servo drives for all rotary driving tasks.

The optimized design with safety class IP65 for motor and fan allows for operation under adverse conditions. Due to their easy-to-service structure, the motors require less maintenance and allow maintenance work to be carried out during ongoing operation.

What is more, **EX-type** IndraDyn A motors can be used in potentially explosive atmospheres under certain conditions. To achieve this, however, the special notes on these motors in [chapter 13 "Motors for Potentially Explosive Atmospheres" on page 291](#) must be observed.

When combined with the controllers from the Rexroth IndraDrive product line, these motors offer intelligent drive solutions with high power density and open functionality.

Introduction to the Product

1.2 About this Documentation

1.2.1 Document Structure

This documentation includes safety regulations, technical data and operating instructions. The following table gives an overview of the contents of this documentation.

Ch.	Title	Content	
1	Introduction	Introduction to the product and notes	
2	Important Instructions on Use	Important safety-related guidelines	
3	Safety		
4	Technical Data	Product description	for project planners and developers
5	Dimension Drawings		
6	Type Codes		
7	Accessories		
8	Connection Method	Practice	for operating and maintenance staff
9	Application Guidelines		
10	Handling and Transport		
11	Installation		
12	Operation		
13	Notes on Motors with Protection Class Ex-px d	Product description	for project planners and developers
14	Service and Support	Additional information	
15	Index		

Fig.1-3: Chapter structure

1.2.2 Related Documentation

Depending on the devices used, related documentation may be required for configuring drive systems with IndraDyn A motors. Rexroth provides the complete product documentation in PDF format in the following Bosch Rexroth media directory:

<http://www.boschrexroth.com/various/utilities/mediadirectory/index.jsp?language=en-GB&publication=NET>

1.2.3 Additional Components

Documentations for external components associated with Bosch Rexroth systems are not included in the scope of delivery and must be ordered directly from the respective manufacturers.

For information on manufacturers, please refer to the appropriate chapters in this documentation.

1.2.4 Your Feedback

Your experiences are an essential part of the process of improving both the product and the documentation.

Please do not hesitate to inform us of any mistakes you detect in this documentation or of any modifications you might desire.

Please send your feedback to:

Bosch Rexroth Electric Drives and Controls GmbH

Dept. DC-IA/EDM3 (fs)

Buergermeister-Dr.-Nebel-Strasse 2

97816 Lohr, Germany

Fax +49 (0) 93 52 / 40-43 80

1.2.5 Standards

This documentation refers to German, European and international technical standards. Documents and sheets on standards are subject to copyright protection and may not be passed on to third parties by Rexroth. Documents and sheets on standards are subject to copyright protection and may not be passed on to third parties by Rexroth. If need be, please contact the authorized sales outlets or, in Germany, directly:

BEUTH Verlag GmbH

Burggrafenstrasse 6

10787 Berlin, Germany

Phone +49 (0) 30-26 01-22 60

Fax +49 (0) 30-26 01-12 60

Internet: <http://www.din.de/beuth>

E-mail: postmaster@beuth.de

2 Important Instructions on Use

2.1 Intended Use

2.1.1 Introduction

Rexroth products are developed and manufactured in accordance with the corresponding state of the art. Before they are delivered, they are inspected to ensure that they operate safely.

The products may only be used in the proper manner. If they are inappropriately used, situations may arise that result in damage to material and personnel.



Regarding damages caused by inappropriate use of the product, Bosch Rexroth, as the manufacturer, does not provide any warranty, assume any liability or pay any damages. Any risks resulting from the products not being used as intended are the sole responsibility of the user.

Before using Bosch Rexroth products, the following prerequisites have to be fulfilled to ensure that they are used as intended:

- Everyone who in any way deals with one of our products must read and understand the corresponding notes regarding safety and regarding the intended use.
- If the products are hardware, they must be kept in their original state, i.e. no constructional modifications must be made. Software products must not be decompiled; their source codes must not be modified.
- Damaged or improperly working products must not be installed or put into operation.
- It must be ensured that the products are installed according to the regulations specified in the documentation.

2.1.2 Areas of Use and Application

Rexroth IndraDyn A series asynchronous motors are designed to be used as rotary main and servo drive motors. The following are typical fields of application:

- Machine tools
- Printing and paper-processing machines
- Packaging and food-processing machines
- Metal-forming machines.

Unit types with different driving powers and different interfaces are available for an application-specific use of the motors.

Controlling and monitoring of the motors may require connection of additional sensors and actuators.



The motors may only be used with the accessories specified in the documentation. Components that are not explicitly mentioned must neither be attached nor connected. The same holds true for cables and lines.

Operation may be carried out only in the explicitly mentioned configurations and combinations of the component and with the software and firmware specified in the corresponding functional description.

Important Instructions on Use

Any connected drive controller must be programmed before startup in order to ensure that the motor executes the functions specific to the particular application.

The motors may only be operated under the assembly, mounting and installation conditions, in the normal position, and under the environmental conditions (temperature, protection class, humidity, EMC, and the like) specified in this documentation.

2.2 Inappropriate Use

Any use of the motors outside of the fields of application mentioned above or under operating conditions and technical data other than those specified in this documentation is considered to be "inappropriate use".

IndraDyn A motors may not be used if:

- They are subject to operating conditions which do not comply with the ambient conditions described above. For example, they must not be operated under water, under extreme temperature fluctuations or extreme maximum temperatures.
- The intended fields of application have not been expressly released for the motors by Rexroth. For this, it is important to observe the statements in the general safety instructions as well as the details in chapters 13 and 14 for explosion protection of the motors.

3 Safety Instructions for Electric Drives and Controls

3.1 Definitions of Terms

Application Documentation	Application documentation comprises the entire documentation used to inform the user of the product about the use and safety-relevant features for configuring, integrating, installing, mounting, commissioning, operating, maintaining, repairing and decommissioning the product. The following terms are also used for this kind of documentation: User Guide, Operation Manual, Commissioning Manual, Instruction Manual, Project Planning Manual, Application Manual, etc.
Component	A component is a combination of elements with a specified function, which are part of a piece of equipment, device or system. Components of the electric drive and control system are, for example, supply units, drive controllers, mains choke, mains filter, motors, cables, etc.
Control System	A control system comprises several interconnected control components placed on the market as a single functional unit.
Device	A device is a finished product with a defined function, intended for users and placed on the market as an individual piece of merchandise.
Electrical Equipment	Electrical equipment encompasses all devices used to generate, convert, transmit, distribute or apply electrical energy, such as electric motors, transformers, switching devices, cables, lines, power-consuming devices, circuit board assemblies, plug-in units, control cabinets, etc.
Electric Drive System	An electric drive system comprises all components from mains supply to motor shaft; this includes, for example, electric motor(s), motor encoder(s), supply units and drive controllers, as well as auxiliary and additional components, such as mains filter, mains choke and the corresponding lines and cables.
Installation	An installation consists of several devices or systems interconnected for a defined purpose and on a defined site which, however, are not intended to be placed on the market as a single functional unit.
Machine	A machine is the entirety of interconnected parts or units at least one of which is movable. Thus, a machine consists of the appropriate machine drive elements, as well as control and power circuits, which have been assembled for a specific application. A machine is, for example, intended for processing, treatment, movement or packaging of a material. The term "machine" also covers a combination of machines which are arranged and controlled in such a way that they function as a unified whole.
Manufacturer	The manufacturer is an individual or legal entity bearing responsibility for the design and manufacture of a product which is placed on the market in the individual's or legal entity's name. The manufacturer can use finished products, finished parts or finished elements, or contract out work to subcontractors. However, the manufacturer must always have overall control and possess the required authority to take responsibility for the product.
Product	Examples of a product: Device, component, part, system, software, firmware, among other things.
Project Planning Manual	A project planning manual is part of the application documentation used to support the sizing and planning of systems, machines or installations.
Qualified Persons	In terms of this application documentation, qualified persons are those persons who are familiar with the installation, mounting, commissioning and operation of the components of the electric drive and control system, as well as with the hazards this implies, and who possess the qualifications their work requires. To comply with these qualifications, it is necessary, among other things,

Safety Instructions for Electric Drives and Controls

- 1) to be trained, instructed or authorized to switch electric circuits and devices safely on and off, to ground them and to mark them
- 2) to be trained or instructed to maintain and use adequate safety equipment
- 3) to attend a course of instruction in first aid

User A user is a person installing, commissioning or using a product which has been placed on the market.

3.2 General Information

3.2.1 Using the Safety Instructions and Passing Them on to Others

Do not attempt to install and operate the components of the electric drive and control system without first reading all documentation provided with the product. Read and understand these safety instructions and all user documentation prior to working with these components. If you do not have the user documentation for the components, contact your responsible Bosch Rexroth sales partner. Ask for these documents to be sent immediately to the person or persons responsible for the safe operation of the components.

If the component is resold, rented and/or passed on to others in any other form, these safety instructions must be delivered with the component in the official language of the user's country.

Improper use of these components, failure to follow the safety instructions in this document or tampering with the product, including disabling of safety devices, could result in property damage, injury, electric shock or even death.

3.2.2 Requirements for Safe Use

Read the following instructions before initial commissioning of the components of the electric drive and control system in order to eliminate the risk of injury and/or property damage. You must follow these safety instructions.

- Bosch Rexroth is not liable for damages resulting from failure to observe the safety instructions.
- Read the operating, maintenance and safety instructions in your language before commissioning. If you find that you cannot completely understand the application documentation in the available language, please ask your supplier to clarify.
- Proper and correct transport, storage, mounting and installation, as well as care in operation and maintenance, are prerequisites for optimal and safe operation of the component.
- Only qualified persons may work with components of the electric drive and control system or within its proximity.
- Only use accessories and spare parts approved by Bosch Rexroth.
- Follow the safety regulations and requirements of the country in which the components of the electric drive and control system are operated.
- Only use the components of the electric drive and control system in the manner that is defined as appropriate. See chapter "Appropriate Use".
- The ambient and operating conditions given in the available application documentation must be observed.
- Applications for functional safety are only allowed if clearly and explicitly specified in the application documentation "Integrated Safety Technology". If this is not the case, they are excluded. Functional safety is a safety

Safety Instructions for Electric Drives and Controls

concept in which measures of risk reduction for personal safety depend on electrical, electronic or programmable control systems.

- The information given in the application documentation with regard to the use of the delivered components contains only examples of applications and suggestions.

The machine and installation manufacturers must

- make sure that the delivered components are suited for their individual application and check the information given in this application documentation with regard to the use of the components,
 - make sure that their individual application complies with the applicable safety regulations and standards and carry out the required measures, modifications and complements.
- Commissioning of the delivered components is only allowed once it is sure that the machine or installation in which the components are installed complies with the national regulations, safety specifications and standards of the application.
 - Operation is only allowed if the national EMC regulations for the application are met.
 - The instructions for installation in accordance with EMC requirements can be found in the section on EMC in the respective application documentation.

The machine or installation manufacturer is responsible for compliance with the limit values as prescribed in the national regulations.

- The technical data, connection and installation conditions of the components are specified in the respective application documentations and must be followed at all times.

National regulations which the user must take into account

- European countries: In accordance with European EN standards
- United States of America (USA):
 - National Electrical Code (NEC)
 - National Electrical Manufacturers Association (NEMA), as well as local engineering regulations
 - Regulations of the National Fire Protection Association (NFPA)
- Canada: Canadian Standards Association (CSA)
- Other countries:
 - International Organization for Standardization (ISO)
 - International Electrotechnical Commission (IEC)

3.2.3 Hazards by Improper Use

- High electrical voltage and high working current! Danger to life or serious injury by electric shock!
- High electrical voltage by incorrect connection! Danger to life or injury by electric shock!
- Dangerous movements! Danger to life, serious injury or property damage by unintended motor movements!
- Health hazard for persons with heart pacemakers, metal implants and hearing aids in proximity to electric drive systems!
- Risk of burns by hot housing surfaces!

Safety Instructions for Electric Drives and Controls

- Risk of injury by improper handling! Injury by crushing, shearing, cutting, hitting!
- Risk of injury by improper handling of batteries!
- Risk of injury by improper handling of pressurized lines!

3.3 Instructions with Regard to Specific Dangers

3.3.1 Protection Against Contact With Electrical Parts and Housings



This section concerns components of the electric drive and control system with voltages of **more than 50 volts**.

Contact with parts conducting voltages above 50 volts can cause personal danger and electric shock. When operating components of the electric drive and control system, it is unavoidable that some parts of these components conduct dangerous voltage.

High electrical voltage! Danger to life, risk of injury by electric shock or serious injury!

- Only qualified persons are allowed to operate, maintain and/or repair the components of the electric drive and control system.
- Follow the general installation and safety regulations when working on power installations.
- Before switching on, the equipment grounding conductor must have been permanently connected to all electric components in accordance with the connection diagram.
- Even for brief measurements or tests, operation is only allowed if the equipment grounding conductor has been permanently connected to the points of the components provided for this purpose.
- Before accessing electrical parts with voltage potentials higher than 50 V, you must disconnect electric components from the mains or from the power supply unit. Secure the electric component from reconnection.
- With electric components, observe the following aspects:
Always wait **30 minutes** after switching off power to allow live capacitors to discharge before accessing an electric component. Measure the electrical voltage of live parts before beginning to work to make sure that the equipment is safe to touch.
- Install the covers and guards provided for this purpose before switching on.
- Never touch electrical connection points of the components while power is turned on.
- Do not remove or plug in connectors when the component has been powered.
- Under specific conditions, electric drive systems can be operated at mains protected by residual-current-operated circuit-breakers sensitive to universal current (RCDs/RCMs).
- Secure built-in devices from penetrating foreign objects and water, as well as from direct contact, by providing an external housing, for example a control cabinet.

High housing voltage and high leakage current! Danger to life, risk of injury by electric shock!

- Before switching on and before commissioning, ground or connect the components of the electric drive and control system to the equipment grounding conductor at the grounding points.

Safety Instructions for Electric Drives and Controls

- Connect the equipment grounding conductor of the components of the electric drive and control system permanently to the main power supply at all times. The leakage current is greater than 3.5 mA.
- Establish an equipment grounding connection with a minimum cross section according to the table below. With an outer conductor cross section smaller than 10 mm² (8 AWG), the alternative connection of two equipment grounding conductors is allowed, each having the same cross section as the outer conductors.

Cross section outer conductor	Minimum cross section equipment grounding conductor Leakage current ≥ 3.5 mA	
	1 equipment grounding conductor	2 equipment grounding conductors
1.5 mm ² (16 AWG)	10 mm ² (8 AWG)	2 × 1.5 mm ² (16 AWG)
2.5 mm ² (14 AWG)		2 × 2.5 mm ² (14 AWG)
4 mm ² (12 AWG)		2 × 4 mm ² (12 AWG)
6 mm ² (10 AWG)		2 × 6 mm ² (10 AWG)
10 mm ² (8 AWG)		-
16 mm ² (6 AWG)	16 mm ² (6 AWG)	-
25 mm ² (4 AWG)		-
35 mm ² (2 AWG)		-
50 mm ² (1/0 AWG)	25 mm ² (4 AWG)	-
70 mm ² (2/0 AWG)	35 mm ² (2 AWG)	-
...

Fig. 3-1: Minimum Cross Section of the Equipment Grounding Connection

3.3.2 Protective Extra-Low Voltage as Protection Against Electric Shock

Protective extra-low voltage is used to allow connecting devices with basic insulation to extra-low voltage circuits.

On components of an electric drive and control system provided by Bosch Rexroth, all connections and terminals with voltages between 5 and 50 volts are PELV ("Protective Extra-Low Voltage") systems. It is allowed to connect devices equipped with basic insulation (such as programming devices, PCs, notebooks, display units) to these connections.

Danger to life, risk of injury by electric shock! High electrical voltage by incorrect connection!

If extra-low voltage circuits of devices containing voltages and circuits of more than 50 volts (e.g., the mains connection) are connected to Bosch Rexroth products, the connected extra-low voltage circuits must comply with the requirements for PELV ("Protective Extra-Low Voltage").

3.3.3 Protection Against Dangerous Movements

Dangerous movements can be caused by faulty control of connected motors. Some common examples are:

Safety Instructions for Electric Drives and Controls

- Improper or wrong wiring or cable connection
- Operator errors
- Wrong input of parameters before commissioning
- Malfunction of sensors and encoders
- Defective components
- Software or firmware errors

These errors can occur immediately after equipment is switched on or even after an unspecified time of trouble-free operation.

The monitoring functions in the components of the electric drive and control system will normally be sufficient to avoid malfunction in the connected drives. Regarding personal safety, especially the danger of injury and/or property damage, this alone cannot be relied upon to ensure complete safety. Until the integrated monitoring functions become effective, it must be assumed in any case that faulty drive movements will occur. The extent of faulty drive movements depends upon the type of control and the state of operation.

Dangerous movements! Danger to life, risk of injury, serious injury or property damage!

A **risk assessment** must be prepared for the installation or machine, with its specific conditions, in which the components of the electric drive and control system are installed.

As a result of the risk assessment, the user must provide for monitoring functions and higher-level measures on the installation side for personal safety. The safety regulations applicable to the installation or machine must be taken into consideration. Unintended machine movements or other malfunctions are possible if safety devices are disabled, bypassed or not activated.

To avoid accidents, injury and/or property damage:

- Keep free and clear of the machine's range of motion and moving machine parts. Prevent personnel from accidentally entering the machine's range of motion by using, for example:
 - Safety fences
 - Safety guards
 - Protective coverings
 - Light barriers
- Make sure the safety fences and protective coverings are strong enough to resist maximum possible kinetic energy.
- Mount emergency stopping switches in the immediate reach of the operator. Before commissioning, verify that the emergency stopping equipment works. Do not operate the machine if the emergency stopping switch is not working.
- Prevent unintended start-up. Isolate the drive power connection by means of OFF switches/OFF buttons or use a safe starting lockout.
- Make sure that the drives are brought to safe standstill before accessing or entering the danger zone.
- Additionally secure vertical axes against falling or dropping after switching off the motor power by, for example,
 - mechanically securing the vertical axes,
 - adding an external braking/arrester/clamping mechanism or
 - ensuring sufficient counterbalancing of the vertical axes.

Safety Instructions for Electric Drives and Controls

- The standard equipment **motor holding brake** or an external holding brake controlled by the drive controller is **not sufficient to guarantee personal safety!**
- Disconnect electrical power to the components of the electric drive and control system using the master switch and secure them from reconnection ("lock out") for:
 - Maintenance and repair work
 - Cleaning of equipment
 - Long periods of discontinued equipment use
- Prevent the operation of high-frequency, remote control and radio equipment near components of the electric drive and control system and their supply leads. If the use of these devices cannot be avoided, check the machine or installation, at initial commissioning of the electric drive and control system, for possible malfunctions when operating such high-frequency, remote control and radio equipment in its possible positions of normal use. It might possibly be necessary to perform a special electromagnetic compatibility (EMC) test.

3.3.4 Protection Against Magnetic and Electromagnetic Fields During Operation and Mounting

Magnetic and electromagnetic fields generated by current-carrying conductors or permanent magnets of electric motors represent a serious danger to persons with heart pacemakers, metal implants and hearing aids.

Health hazard for persons with heart pacemakers, metal implants and hearing aids in proximity to electric components!

- Persons with heart pacemakers and metal implants are not allowed to enter the following areas:
 - Areas in which components of the electric drive and control systems are mounted, commissioned and operated.
 - Areas in which parts of motors with permanent magnets are stored, repaired or mounted.
- If it is necessary for somebody with a heart pacemaker to enter such an area, a doctor must be consulted prior to doing so. The noise immunity of implanted heart pacemakers differs so greatly that no general rules can be given.
- Those with metal implants or metal pieces, as well as with hearing aids, must consult a doctor before they enter the areas described above.

3.3.5 Protection Against Contact With Hot Parts

Hot surfaces of components of the electric drive and control system. Risk of burns!

- Do not touch hot surfaces of, for example, braking resistors, heat sinks, supply units and drive controllers, motors, windings and laminated cores!
- According to the operating conditions, temperatures of the surfaces can be **higher than 60 °C (140 °F)** during or after operation.
- Before touching motors after having switched them off, let them cool down for a sufficient period of time. Cooling down can require **up to 140 minutes!** The time required for cooling down is approximately five times the thermal time constant specified in the technical data.

Safety Instructions for Electric Drives and Controls

- After switching chokes, supply units and drive controllers off, wait **15 minutes** to allow them to cool down before touching them.
- Wear safety gloves or do not work at hot surfaces.
- For certain applications, and in accordance with the respective safety regulations, the manufacturer of the machine or installation must take measures to avoid injuries caused by burns in the final application. These measures can be, for example: Warnings at the machine or installation, guards (shieldings or barriers) or safety instructions in the application documentation.

3.3.6 Protection During Handling and Mounting

Risk of injury by improper handling! Injury by crushing, shearing, cutting, hitting!

- Observe the relevant statutory regulations of accident prevention.
- Use suitable equipment for mounting and transport.
- Avoid jamming and crushing by appropriate measures.
- Always use suitable tools. Use special tools if specified.
- Use lifting equipment and tools in the correct manner.
- Use suitable protective equipment (hard hat, safety goggles, safety shoes, safety gloves, for example).
- Do not stand under hanging loads.
- Immediately clean up any spilled liquids from the floor due to the risk of falling!

3.3.7 Battery Safety

Batteries consist of active chemicals in a solid housing. Therefore, improper handling can cause injury or property damage.

Risk of injury by improper handling!

- Do not attempt to reactivate low batteries by heating or other methods (risk of explosion and cauterization).
- Do not attempt to recharge the batteries as this may cause leakage or explosion.
- Do not throw batteries into open flames.
- Do not dismantle batteries.
- When replacing the battery/batteries, do not damage the electrical parts installed in the devices.
- Only use the battery types specified for the product.



Environmental protection and disposal! The batteries contained in the product are considered dangerous goods during land, air, and sea transport (risk of explosion) in the sense of the legal regulations. Dispose of used batteries separately from other waste. Observe the national regulations of your country.

Safety Instructions for Electric Drives and Controls

3.3.8 Protection Against Pressurized Systems

According to the information given in the Project Planning Manuals, motors and components cooled with liquids and compressed air can be partially supplied with externally fed, pressurized media, such as compressed air, hydraulics oil, cooling liquids and cooling lubricants. Improper handling of the connected supply systems, supply lines or connections can cause injuries or property damage.

Risk of injury by improper handling of pressurized lines!

- Do not attempt to disconnect, open or cut pressurized lines (risk of explosion).
- Observe the respective manufacturer's operating instructions.
- Before dismantling lines, relieve pressure and empty medium.
- Use suitable protective equipment (safety goggles, safety shoes, safety gloves, for example).
- Immediately clean up any spilled liquids from the floor due to the risk of falling!



Environmental protection and disposal! The agents (e.g., fluids) used to operate the product might not be environmentally friendly. Dispose of agents harmful to the environment separately from other waste. Observe the national regulations of your country.

3.4 Explanation of Signal Words and the Safety Alert Symbol

The Safety Instructions in the available application documentation contain specific signal words (DANGER, WARNING, CAUTION or NOTICE) and, where required, a safety alert symbol (in accordance with ANSI Z535.6-2006).

The signal word is meant to draw the reader's attention to the safety instruction and identifies the hazard severity.

The safety alert symbol (a triangle with an exclamation point), which precedes the signal words DANGER, WARNING and CAUTION, is used to alert the reader to personal injury hazards.

DANGER

In case of non-compliance with this safety instruction, death or serious injury **will** occur.

WARNING

In case of non-compliance with this safety instruction, death or serious injury **could** occur.

CAUTION

In case of non-compliance with this safety instruction, minor or moderate injury **could** occur.

Safety Instructions for Electric Drives and Controls

NOTICE

In case of non-compliance with this safety instruction, property damage could occur.

4 Technical Data

4.1 Operation Modes

4.1.1 General Information

Bosch Rexroth motors are documented according to the test criteria and measuring methods of EN 60034-1. The technical data specified below refers to operation modes S1 (continuous operation) and S6 (periodic operation), each with surface cooling through direct-connected fan units or liquid cooling.

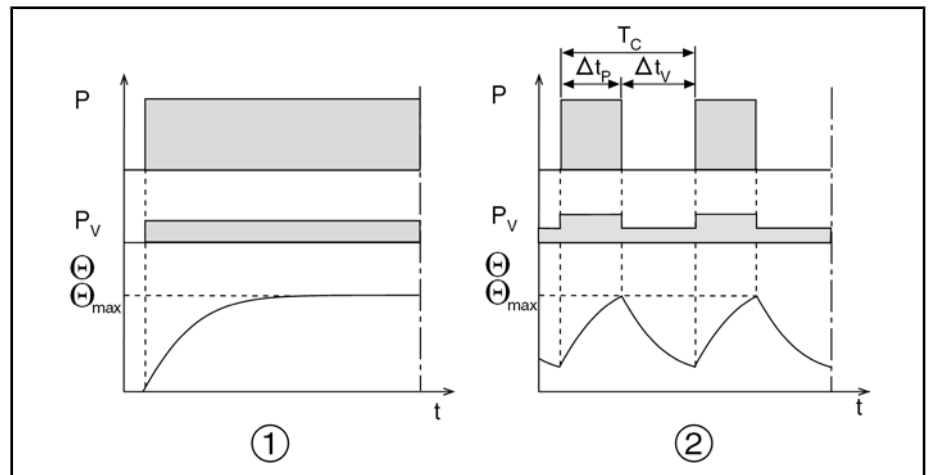

- ① Operation mode S1
- ② Operation mode S6
- P Load
- P_V Electric losses
- Θ Temperature
- Θ_{max} Highest temperature (stator)
- t Time
- T_C Cycle time
- Δt_P Operating time with constant load
- Δt_V Idle time

Fig. 4-1: Operation modes according to EN 60034-1

4.1.2 Duty Cycle

Operation mode S6 is specified along with the duty cycle (ED) in %. The duty cycle (ED) is calculated as follows:

$$ED = \frac{\Delta t_P}{T_C} \cdot 100\%$$

- ED Duty cycle in %
- Δt_P Operating time with constant load
- T_C Cycle time

Fig. 4-2: Duty cycle

Technical Data

4.2 Operating Behavior

4.2.1 Description of the Parameters Specified

Rated torque	M_N = available torque at rated speed in operation mode S1 (continuous mode). Unit: newton meter [Nm].
Rated power	P_N = output power of the motor at rated speed and load with rated torque, specified in kilowatt [kW].
Rated current	I_N = phase current of the motor at rated speed and load with rated torque, specified as r.m.s. value in ampere [A].
Rated speed	n_N = working speed defined by the manufacturer. Depending on the particular application, other working speeds are possible (see torque-speed characteristic curve).
Maximum torque	<p>M_{max} = maximum torque that can be supplied at maximum current I_{max}, specified in newton meter [Nm].</p> <ul style="list-style-type: none"> The reachable maximum torque depends on the drive controller used. The only binding maximum torque M_{max} is that specified in the selection lists.
Maximum power	<p>P_{max} = maximum output power of the motor at 540 V_{DC}, specified in kilowatt [kW].</p> <ul style="list-style-type: none"> The reachable maximum power depends on the drive controller used and on the supply voltage. To allow uniform presentation of motor characteristic curves, P_{max} is specified at the same speed at which M_{max} can also be output. However, the actually reachable P_{max} value may be different and is specified in the data sheet of the motor. Therefore, the only binding maximum power is that specified in the technical data (data sheet).
Maximum current	<p>I_{max} = maximum briefly allowed phase current of the motor, that has no damaging effect on the winding, specified as r.m.s. value in ampere [A].</p> <ul style="list-style-type: none"> To avoid thermal overload during operation of the motor with external controllers, note that the current is to be reduced to 2.2 times the rated current after 400 ms and that I_{max} may be reapplied only if the winding temperature is in the allowed range and the degree of relief of the motor permits this.
Maximum speed	n_{max} = maximum allowed speed of the motor in (min ⁻¹), depending on the selected bearing type. The maximum speed can be limited by mechanical factors, such as centrifugal forces, bearing wear and use of a holding brake.
<hr/>	
 Please observe the maximum speed of the holding brake (optional).	
Torque constant at the nominal working point and at 20 °C	$K_{M,N}$ = ratio of torque increase to motor torque-forming current. Manufacturing tolerances ± 5 %. Unit: [Nm/A]. Applicable up to the rated current I_N .
Discharge capacity	C_{ab} = capacity of short-circuited power connections U, V, W against the motor housing. Unit: [nF].
Power wire cross-section A	Unit: [mm ²]. Rated for cables by current carrying capacity according to VDE 0298-4 and laying type B2 according to EN 60204-1 at a Ambient air temperature of 40 °C. The power wire cross-section specified in the data sheet may be different, depending on the selected connection type (connector socket or terminal box). When selecting the appropriate power cable, therefore please

observe the information given in [chapter 8 "Connection Methods"](#) on page 207.

- Rotor moment of inertia** J_{rot} = moment of inertia of the rotor without bearing, brake and motor encoder. Unit: [kgm²].
- Motor mass** m = motor mass in standard design, without holding brake, specified in kilogram [kg].
- Sound pressure level** L_p = at a distance of 1 m, with PWM = 4 kHz. Unit: [dB(A)].
- Thermal time constant** T_{th} = duration of the temperature rise to 63% of the final temperature of the motor under load at rated torque in S1 mode and surface sooling by direct-connected fan units.

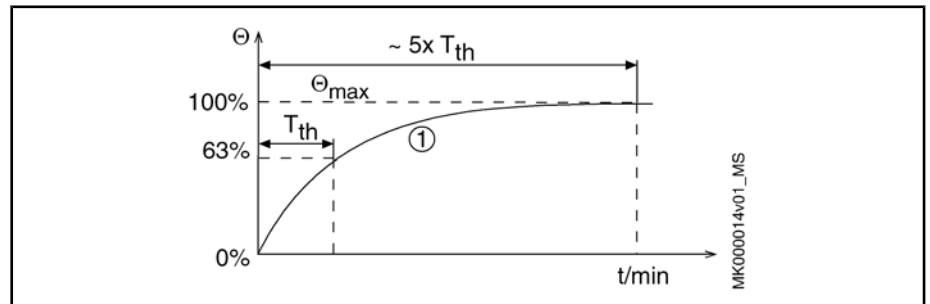

① Curve of the motor temperature over time
 T_{th} Thermal time constant

Fig.4-3: Thermal time constant

- Cycle duration** T_C = duration of the cycle in S6 mode, required to reach the thermal steady-state condition where the maximum temperature value corresponds to the final temperature in S1 mode (see [fig. 4-1 "Operation modes according to EN 60034-1"](#) on page 27).

- Number of pole pairs** p = number of pole pairs of the motor.
- Allowed coolant supply temperature** See information in [chapter 9.8.6 "Coolant Supply Temperature"](#) on page 237.
- Constant for determining the pressure drop with water as cooling medium** Δp_{diff} = pressure drop in bar without quick coupling at Q_{min} .
 If the coolant port is provided with a quick coupling (optional), the following constant of the quick coupling must be taken into account in addition to the pressure drop constant specified in the data sheet:

MAF100...130 :	$k_{dp2} = 0,032 \text{ bar} / (\text{l/min})^{1,75}$
MAF160...225 :	$k_{dp2} = 0,036 \text{ bar} / (\text{l/min})^{1,75}$

k_{dp2} Pressure drop constant of the quick coupling
 l/min Coolant flow rate

Fig.4-4: Constant for determining the pressure drop with quick coupling

When the quick coupling (optional) is used, this results in the following pressure drop across the complete motor:

Technical Data

$$\Delta p_{diff2} = (k_{dp} + k_{dp2}) \cdot Q_{min}^{1,75}$$

Δp_{diff2}	Pressure drop with quick coupling
k_{dp}	Constant without quick coupling (see motor data sheet)
k_{dp2}	Constant with quick coupling
Q_{min}	See motor data sheet
Fig.4-5:	Pressure drop with quick coupling



When other couplings or coolant ports are used, the customer must take the corresponding pressure drop value into account while designing the coolant system.

Maximum allowed coolant input pressure

See [chapter 8.9.3 "Coolant Input Pressure "](#) on page 222.

4.2.2 Example Characteristic Curves

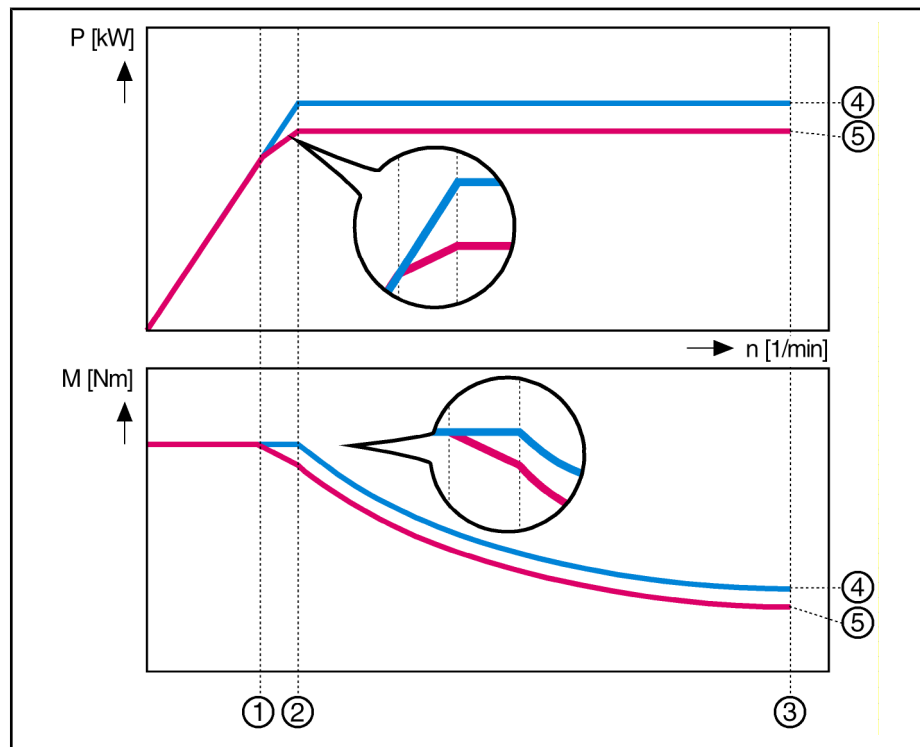

P	Mechanical output power in kilowatt [kW]
M	Torque available at the output shaft in newton meter [Nm]
n	Motor speed in revolutions per minute [min^{-1}]
①	Key speed (n_1 in data sheet)
②	Rated speed (n_N)
③	Maximum speed (n_{max})
④	Characteristic curve without derating
⑤	Characteristic curve with derating
Fig.4-6:	Example IndraDyn A characteristic curves



The reachable motor torque depends on the drive controller used. The reference value for the presentation of the motor characteristic curves is an unregulated DC bus voltage of 540 V_{DC}.

Explanation:

Technical Data

- (1) **Key speed** Start of a drop in torque and power before the rated speed n_N is reached. This behavior is referred to as **Derating** and is only displayed by certain motor winding versions. **If there is no derating behavior, the key speed is equal to the rated speed.**
- Before the key speed is reached, the continuous current at standstill I_1 is applicable (effective value). **If there is no derating behavior, the continuous current at standstill is equal to the rated current I_N .**
- Before the key speed is reached, the continuous torque at standstill M_1 is available for S1 mode. **If there is no derating behavior, the continuous torque at standstill is equal to the rated torque M_N .**
- If derating is in effect, the torque is reduced once the key speed is reached. [fig. 4-6 " Example IndraDyn A characteristic curves" on page 30](#) shows two characteristic curves each starting at key speed.
- (2) **Rated speed** If derating is not in effect, asynchronous motors provide a constant torque (rated torque) until the rated speed is reached; thereafter, the constant **rated power P_N** is available.
- (3) **Maximum speed** Speed limit up to which a motor can be safely operated. Usually limited by the mechanical construction (bearing) or by the use of a holding brake.

Technical Data

4.3 Technical Data of MAD100

4.3.1 Data Sheet of MAD100B

Parameter	Symbol	Unit	MAD100B				
			0050	0100	0150	0200	0250
Rated torque ¹⁾	M_N	Nm	34.0	31.0	30.0	28.0	25.0
Rated power	P_N	kW	1.80	3.20	4.71	5.90	6.50
Rated current	I_N	A	5.3	8.9	12.9	14.6	16.2
Rated speed	n_N	1/min	500	1,000	1,500	2,000	2,500
Key speed	n_1	1/min	500		1,000	1,500	2,000
Maximum speed with bearing A	n_{max}	1/min	3,000	6,000	9,000		
Maximum speed with bearing H	n_{max}	1/min	3,000	6,000	9,000	11,000	
Maximum speed with bearing N	n_{max}	1/min	3,000	6,000	9,000		
Maximum torque	M_{max}	Nm	75.1	74.7	68.0	66.2	61.5
Maximum power	P_{S6max}	kW	3.69	6.56	9.66	12.10	13.33
Maximum current	$I_{max(eff)}$	A	10.3	18.0	23.5	28.9	28.3
Continuous torque at standstill	M_{n1}	Nm	34.0		31.0	30.0	28.0
Continuous current at standstill	I_{n1}	A	5.3	9.4	13.0	15.3	16.2
Torque constant at 20 °C	$K_{M,N}$	Nm/A	7.66	4.31	2.83	2.41	2.11
Thermal time constant	$T_{th,enn}$	min	20.0				
Cycle duration (S6 - 44%)	T_C	min	10				
Discharge capacity of the component	C_{ab}	nF	6.0	5.7		6.0	
Number of pole pairs	p	--	3				
Power wire cross-section	A	mm ²	1.5				2.5
Mass	m_{mot}	kg	43.0				
Rotor moment of inertia	J_{rot}	kg * m ²	0.0190000				
Sound pressure level	L_P	dB[A]	70 (+3)				
Ambient air temperature during operation	T_{um}	°C	0...+40				
Insulation class according to DIN EN 60034-1	I.CL.	-	155				

Last revision: 2008-08-06

1) Please note the information on the specified parameters at the beginning of this chapter
 Fig.4-7: MAD100B - Technical data

4.3.2 Motor Characteristic Curves of MAD100B

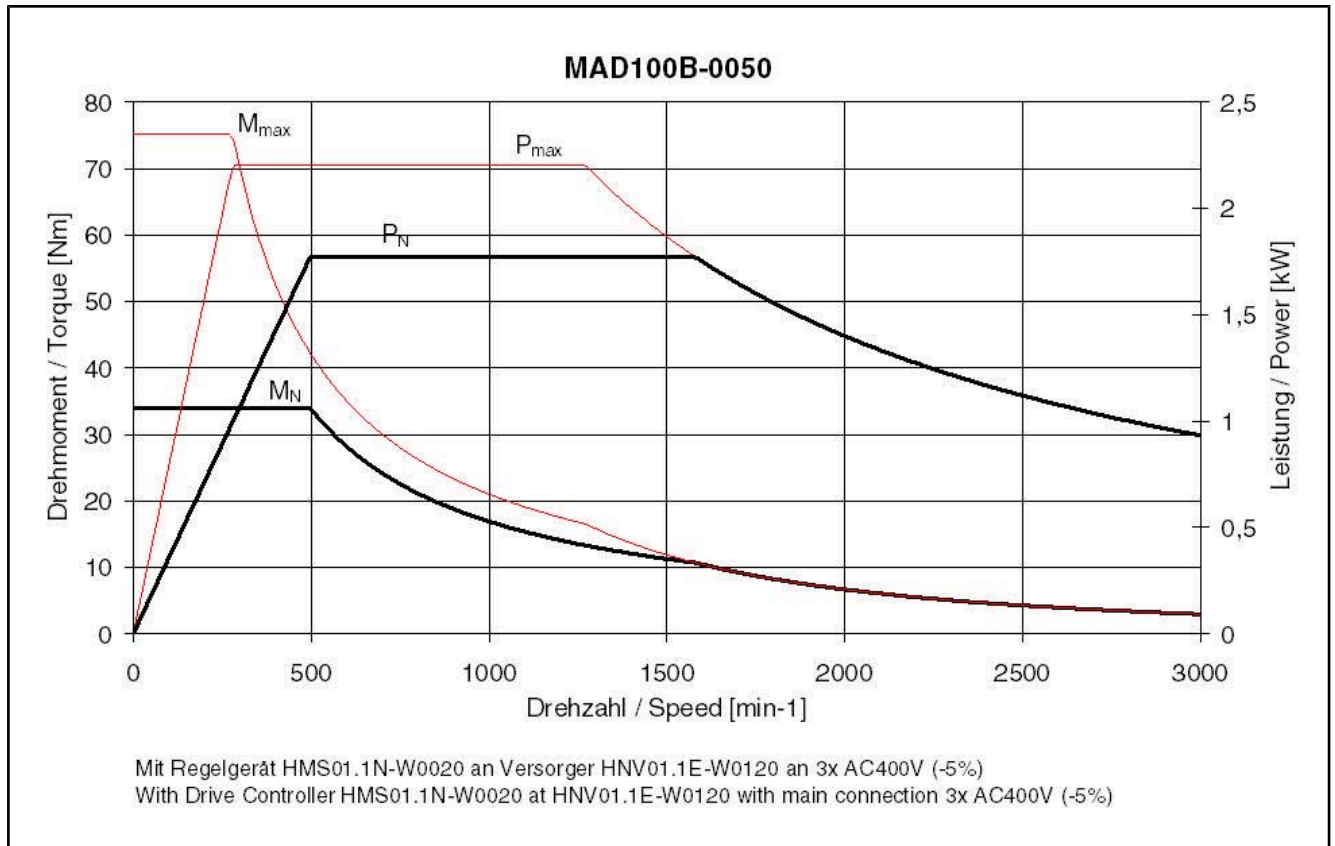

Fig.4-8: Motor characteristic curve of MAD100B-0050

Technical Data

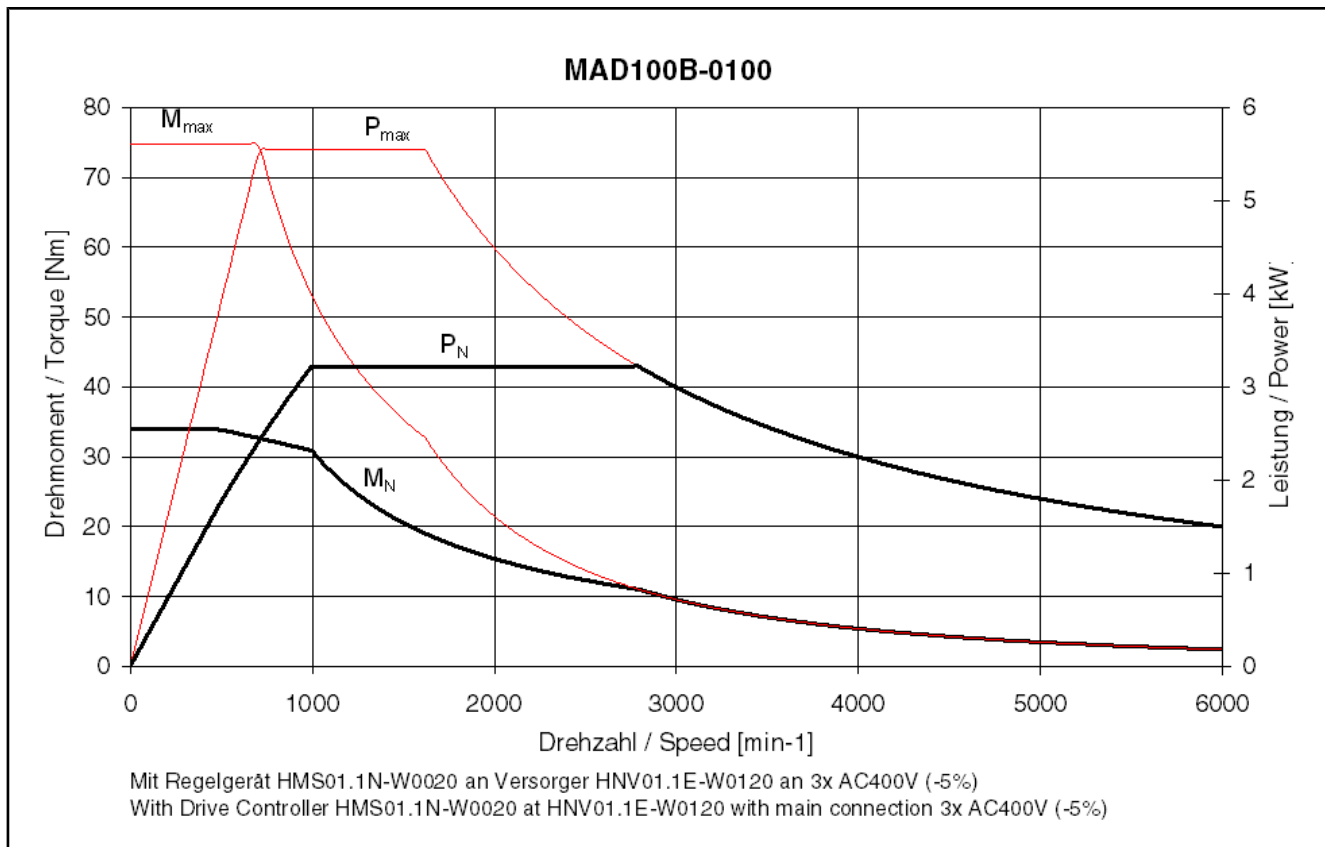

Fig.4-9: Motor characteristic curve of MAD100B-0100

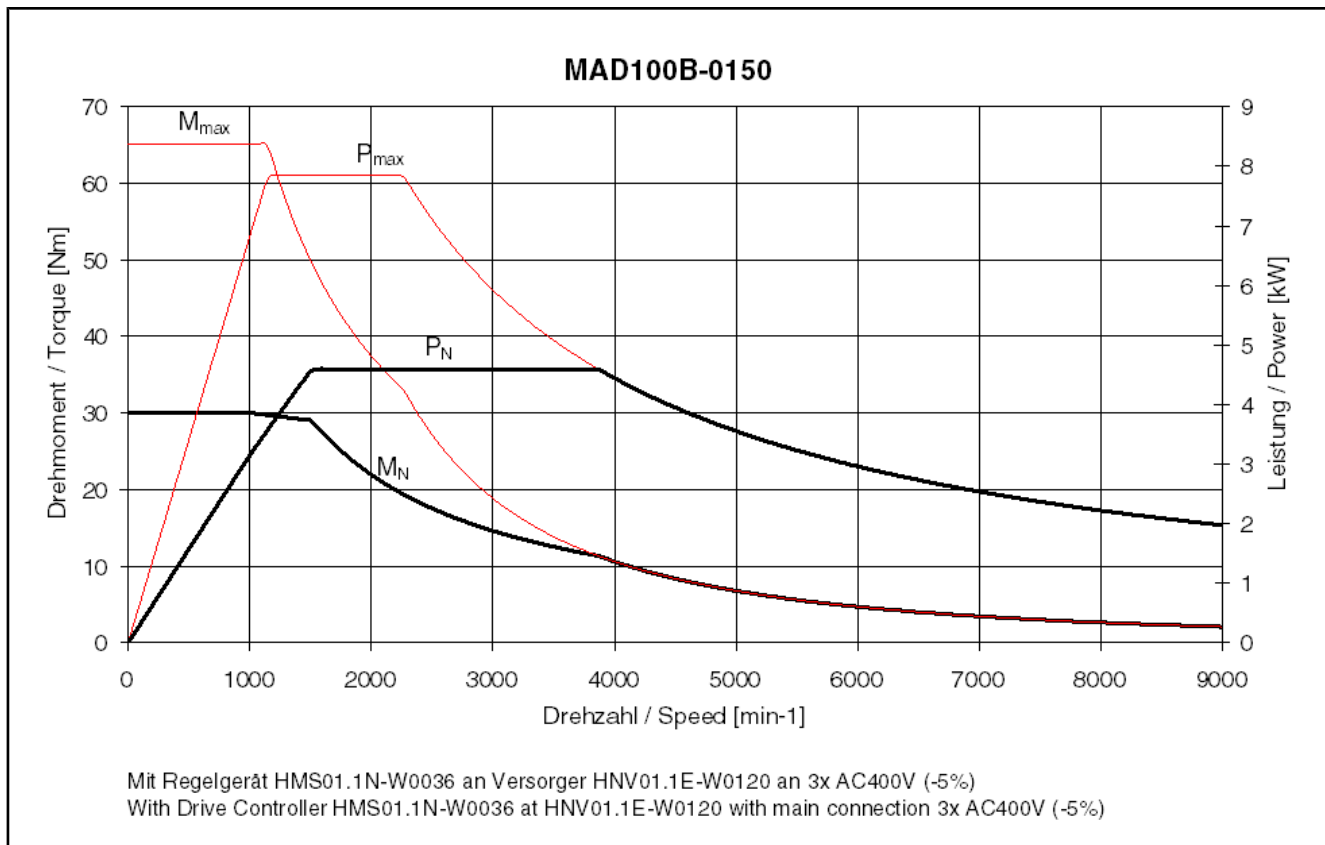

Fig.4-10: Motor characteristic curve of MAD100B-0150

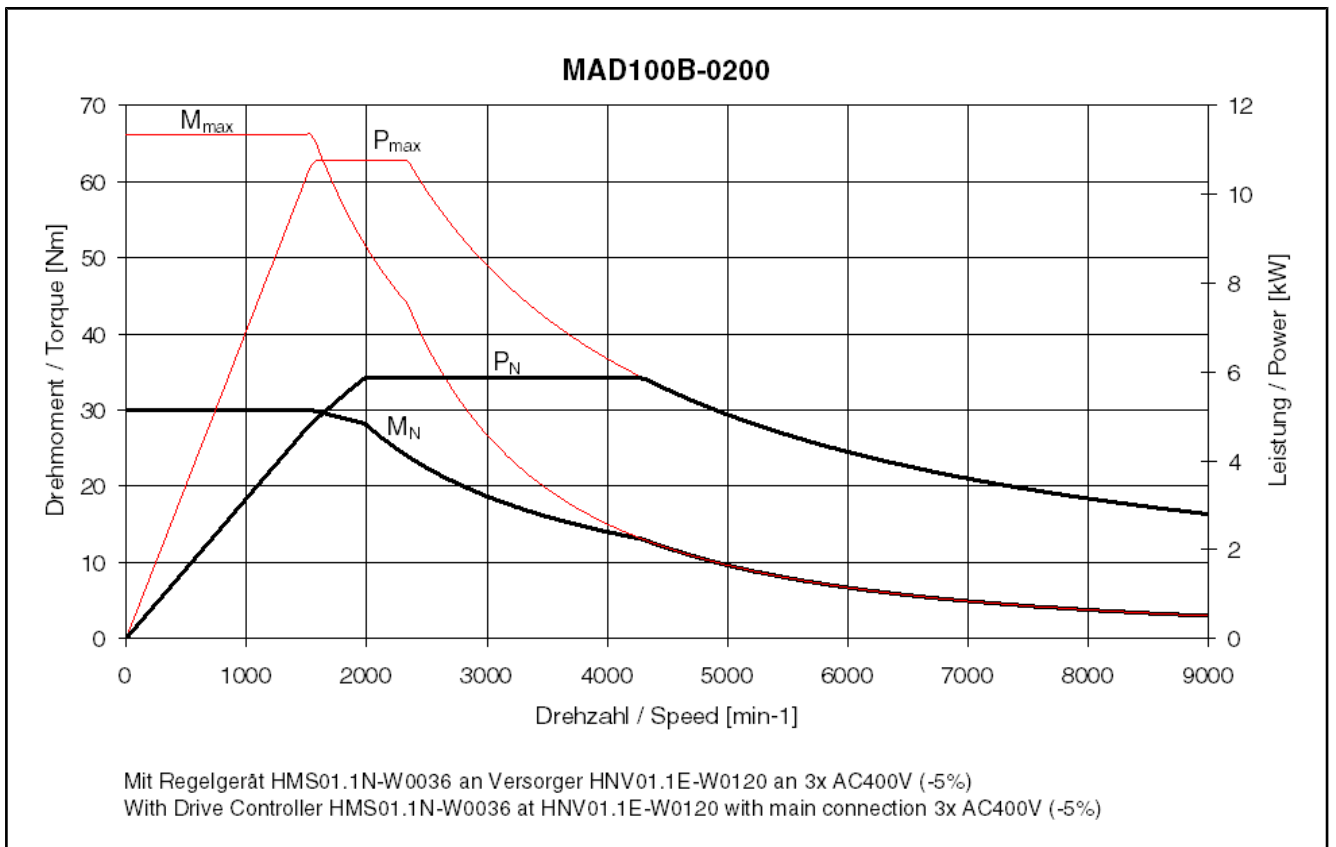

Fig.4-11: Motor characteristic curve of MAD100B-0200

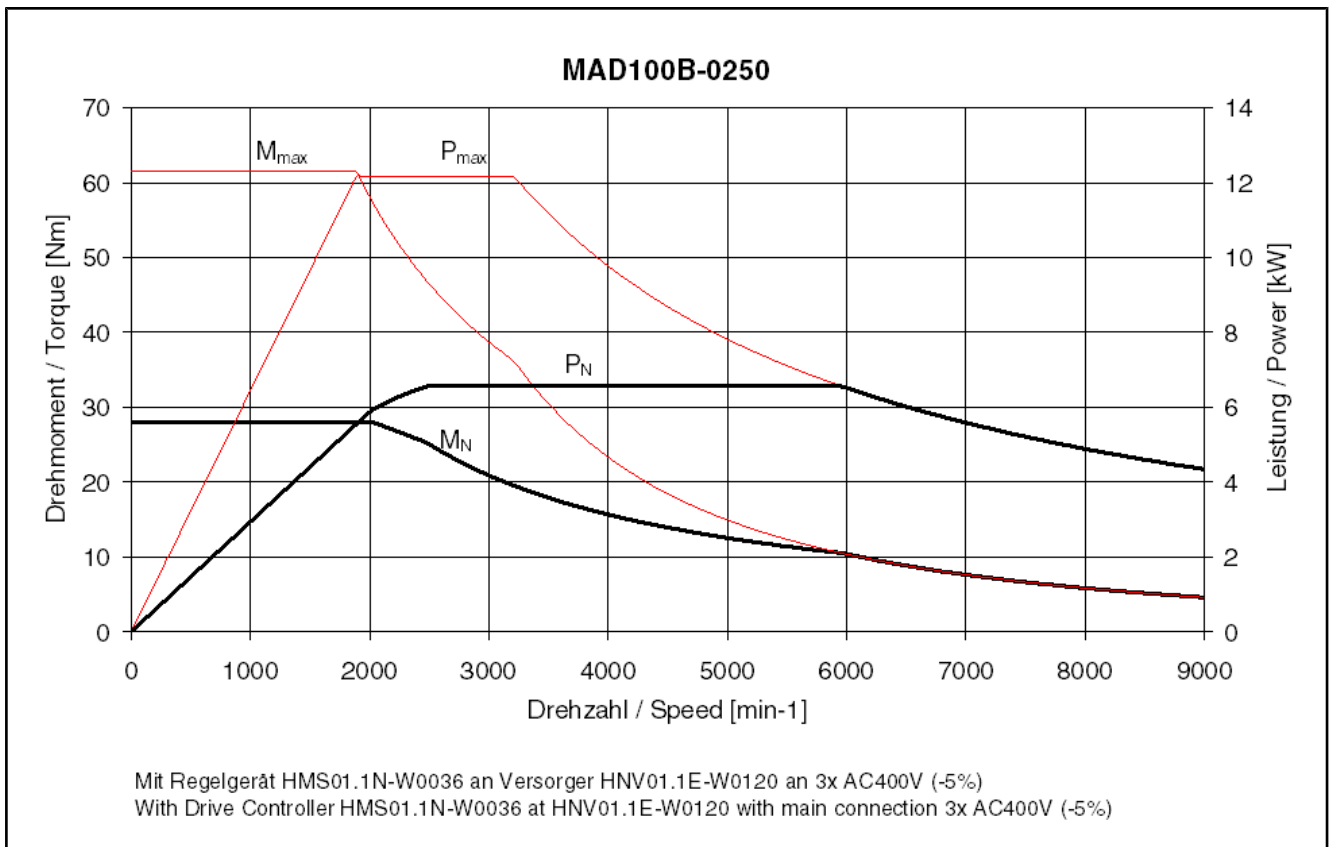

Fig.4-12: Motor characteristic curve of MAD100B-0250

Technical Data

4.3.3 Data Sheet of MAD100C

Parameter	Symbol	Unit	MAD100C				
			0050	0100	0150	0200	0250
Rated torque ¹⁾	M_N	Nm	51.0	50.0	48.0	45.0	40.0
Rated power	P_N	kW	2.70	5.20	7.50	9.40	10.47
Rated current	I_N	A	8.2	13.2	19.7	25.7	27.8
Rated speed	n_N	1/min	500	1,000	1,500	2,000	2,500
Key speed	n_1	1/min	500		1,000	1,500	2,000
Maximum speed with bearing A	n_{max}	1/min	3,000	6,000	9,000		
Maximum speed with bearing H	n_{max}	1/min	3,000	6,000	9,000	11,000	
Maximum speed with bearing N	n_{max}	1/min	3,000	6,000	9,000		
Maximum torque	M_{max}	Nm	112.3	118.8	110.4	105.5	91.0
Maximum power	P_{S6max}	kW	5.54	10.66	15.38	19.27	22.50
Maximum current	$I_{max(eff)}$	A	15.9	25.4	39.0	47.3	64.3
Continuous torque at standstill	M_{n1}	Nm	51.0	54.0	50.0	48.0	42.0
Continuous current at standstill	I_{n1}	A	8.2	13.8	20.2	26.6	28.8
Torque constant at 20 °C	$K_{M,N}$	Nm/A	7.40	4.94	2.94	2.41	1.67
Thermal time constant	T_{th_nenn}	min	20.0				
Cycle duration (S6 - 44%)	T_C	min	10				
Discharge capacity of the component	C_{ab}	nF	9.0	8.5	8.1	8.5	9.2
Number of pole pairs	p	--	3				
Power wire cross-section	A	mm ²	1.5		2.5	4.0	
Mass	m_{mot}	kg	59.0				
Rotor moment of inertia	J_{rot}	kg * m ²	0.0284000				
Sound pressure level	L_P	dB[A]	70 (+3)				
Ambient air temperature during operation	T_{um}	°C	0...+40				
Insulation class according to DIN EN 60034-1	I.CL.	-	155				

Last revision: 2008-08-05

1) Please note the information on the specified parameters at the beginning of this chapter
 Fig.4-13: MAD100C - Technical data

4.3.4 Motor Characteristic Curves of MAD100C

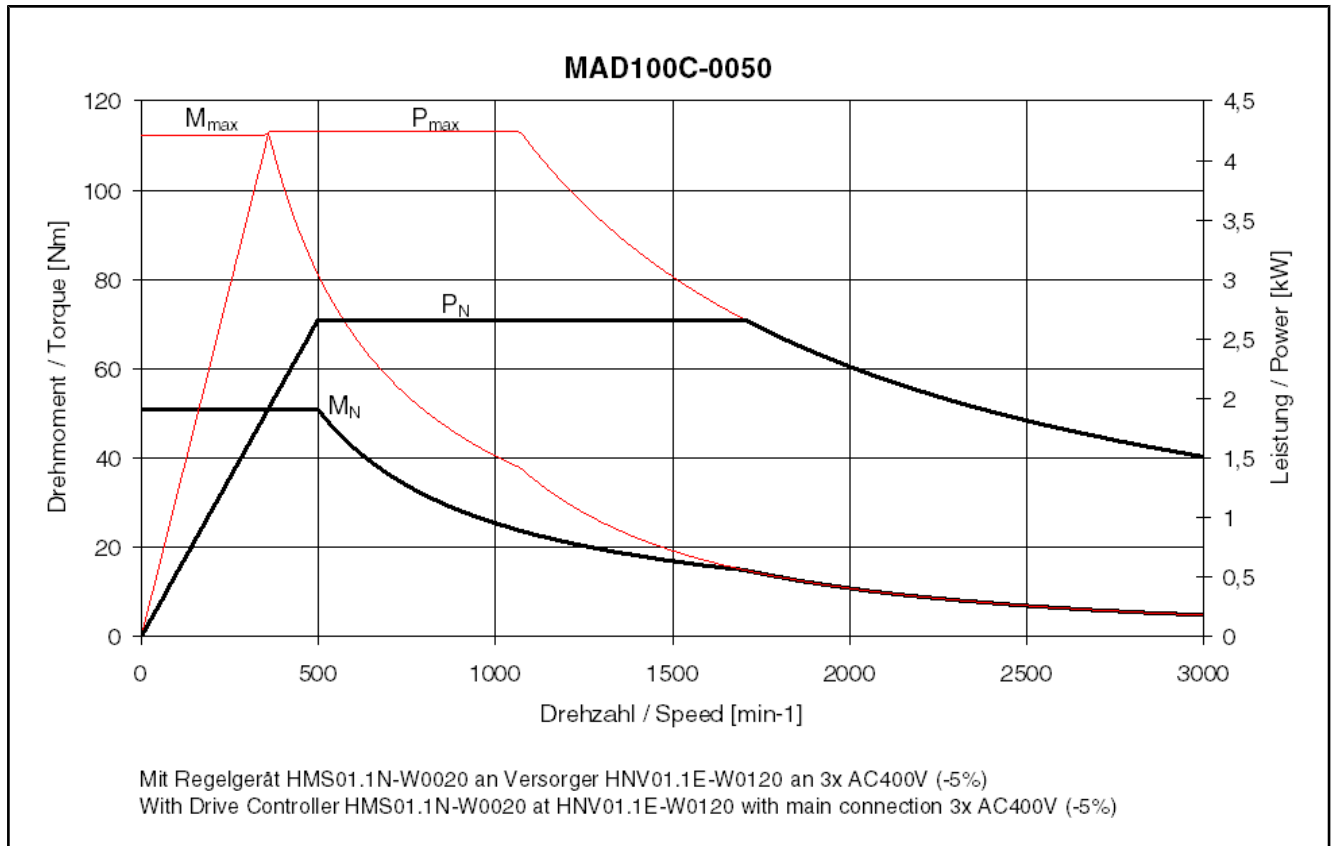

Fig.4-14: Motor characteristic curve of MAD100C-0050

Technical Data

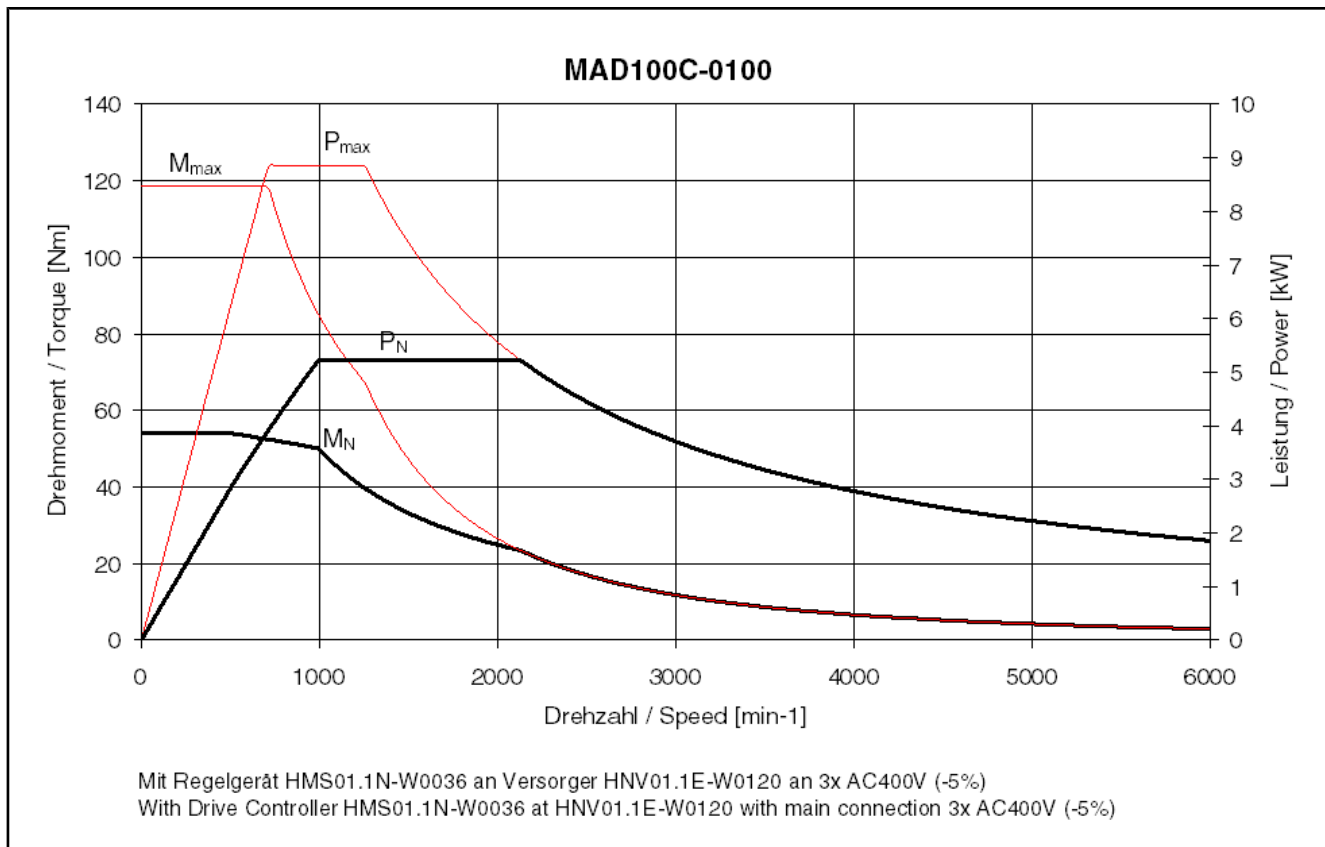

Fig.4-15: Motor characteristic curve of MAD100C-0100

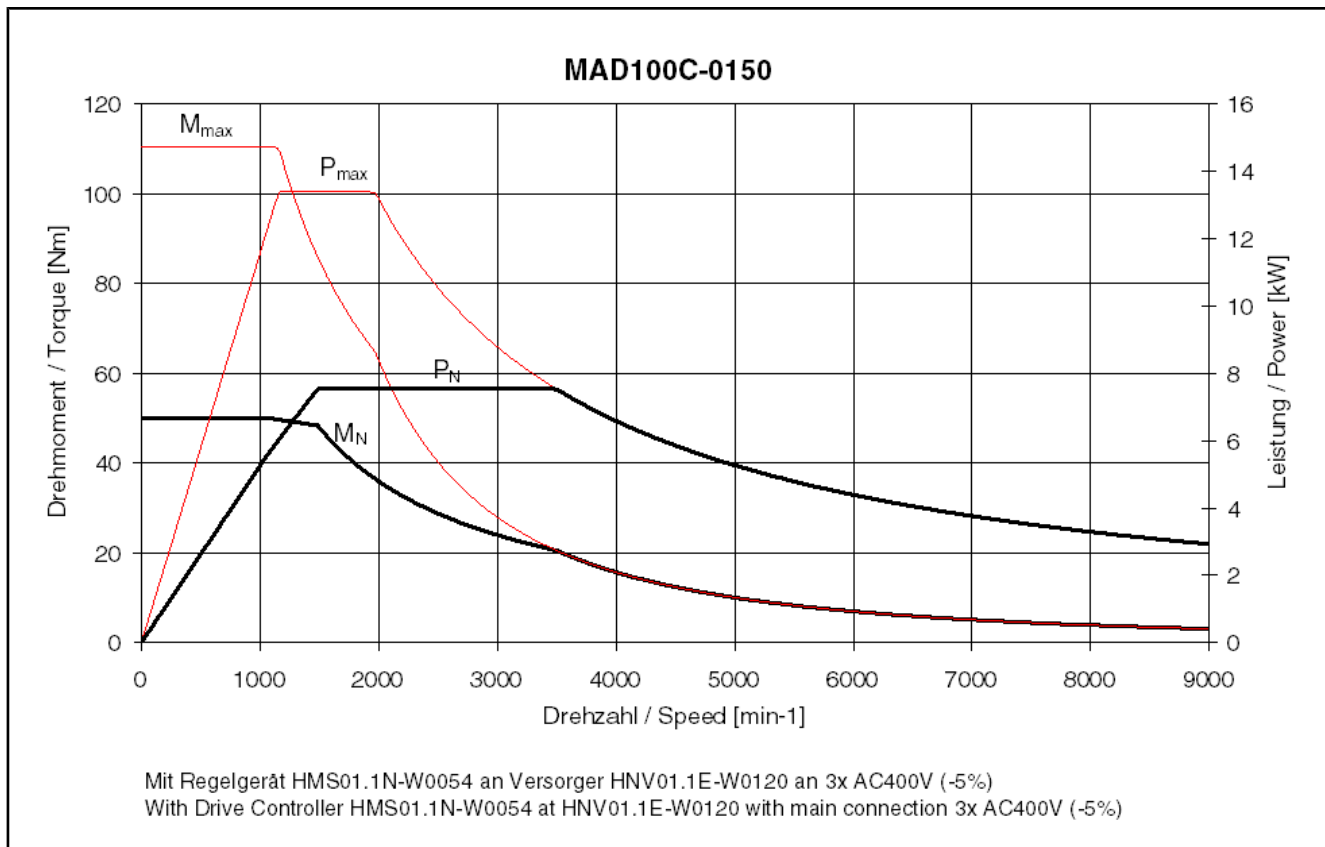

Fig.4-16: Motor characteristic curve of MAD100C-0150

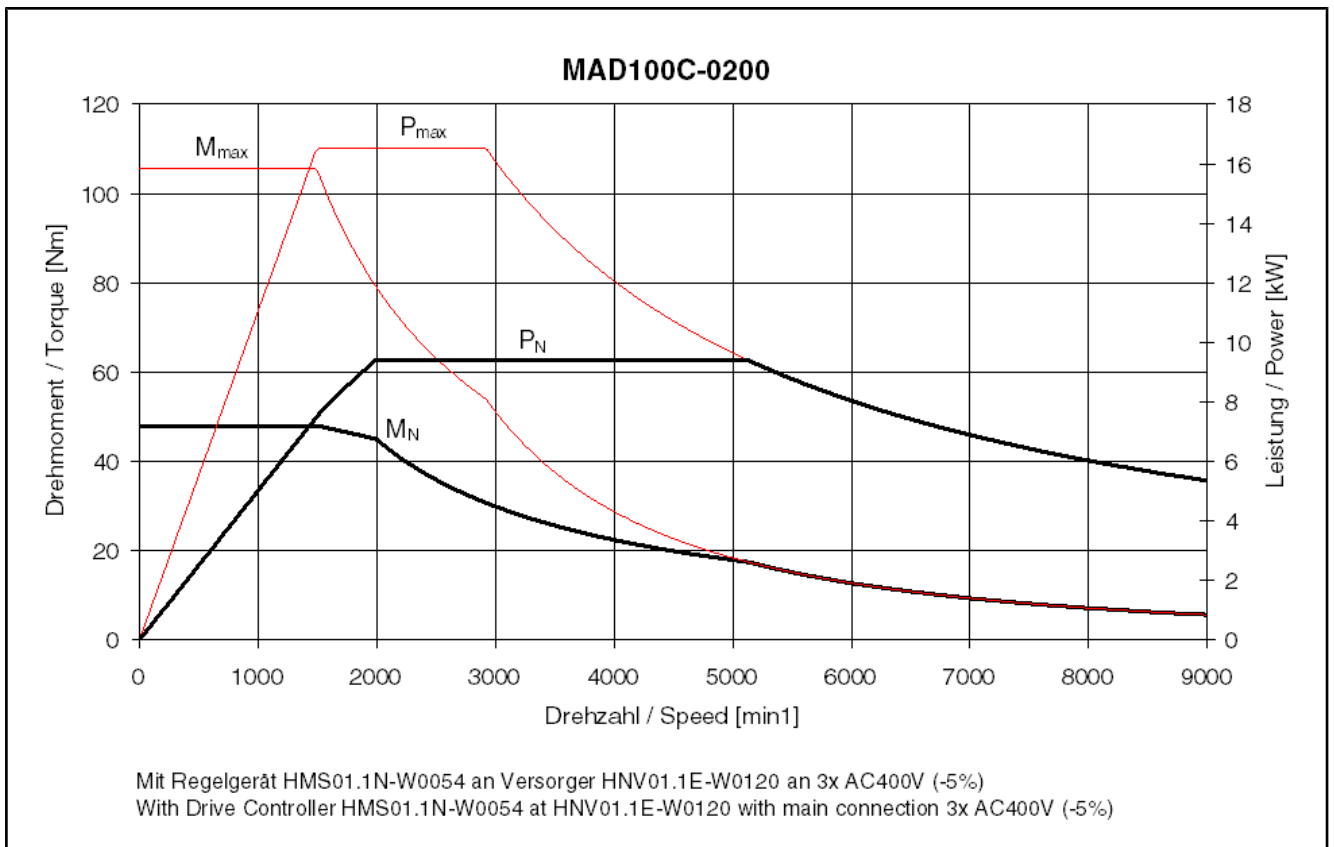

Fig.4-17: Motor characteristic curve of MAD100C-0200

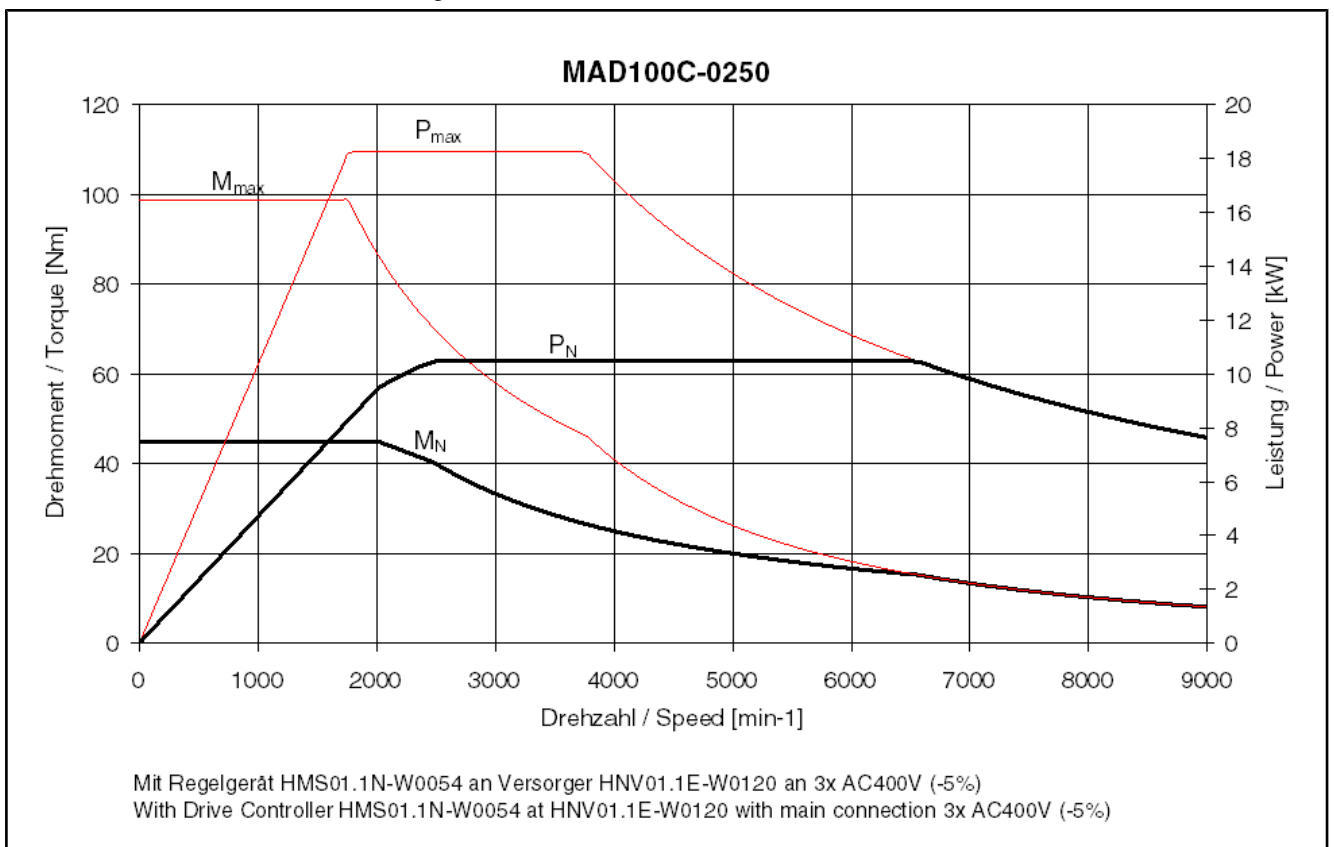

Fig.4-18: Motor characteristic curve of MAD100C-0250

Technical Data

4.3.5 Data Sheet of MAD100D

Parameter	Symbol	Unit	MAD100D				
			0050	0100	0150	0200	0250
Rated torque ¹⁾	M_N	Nm	70.0	64.0	59.0	54.0	50.0
Rated power	P_N	kW	3.70	6.70	9.27	11.30	13.10
Rated current	I_N	A	10.1	19.3	24.7	27.2	32.4
Rated speed	n_N	1/min	500	1,000	1,500	2,000	2,500
Key speed	n_1	1/min	500		1,000	1,500	2,000
Maximum speed with bearing A	n_{max}	1/min	3,000	6,000	9,000		
Maximum speed with bearing H	n_{max}	1/min	3,000	6,000	9,000	11,000	
Maximum speed with bearing N	n_{max}	1/min	3,000	6,000	9,000		
Maximum torque	M_{max}	Nm	153.6	146.5	140.8	129.8	118.7
Maximum power	P_{S6max}	kW	7.59	13.74	19.07	23.17	26.86
Maximum current	$I_{max(eff)}$	A	19.1	34.3	47.6	52.7	64.0
Continuous torque at standstill	M_{n1}	Nm	70.0		64.0	59.0	54.0
Continuous current at standstill	I_{n1}	A	10.1	20.4	25.6	28.6	34.7
Torque constant at 20 °C	$K_{M,N}$	Nm/A	8.52	4.50	3.19	2.62	2.04
Thermal time constant	T_{th_nenn}	min	20.0				
Cycle duration (S6 - 44%)	T_C	min	10				
Discharge capacity of the component	C_{ab}	nF	11.0		10.2	11.5	11.9
Number of pole pairs	p	--	3				
Power wire cross-section	A	mm ²	1.5	2.5	4.0		6.0
Mass	m_{mot}	kg	72.0				
Rotor moment of inertia	J_{rot}	kg * m ²	0.0392000				
Sound pressure level	L_P	dB[A]	70 (+3)				
Ambient air temperature during operation	T_{um}	°C	0...+40				
Insulation class according to DIN EN 60034-1	I.CL.	-	155				

Last revision: 2009-03-20

1) Please note the information on the specified parameters at the beginning of this chapter
 Fig.4-19: MAD100D - Technical data

4.3.6 Motor Characteristic Curves of MAD100D

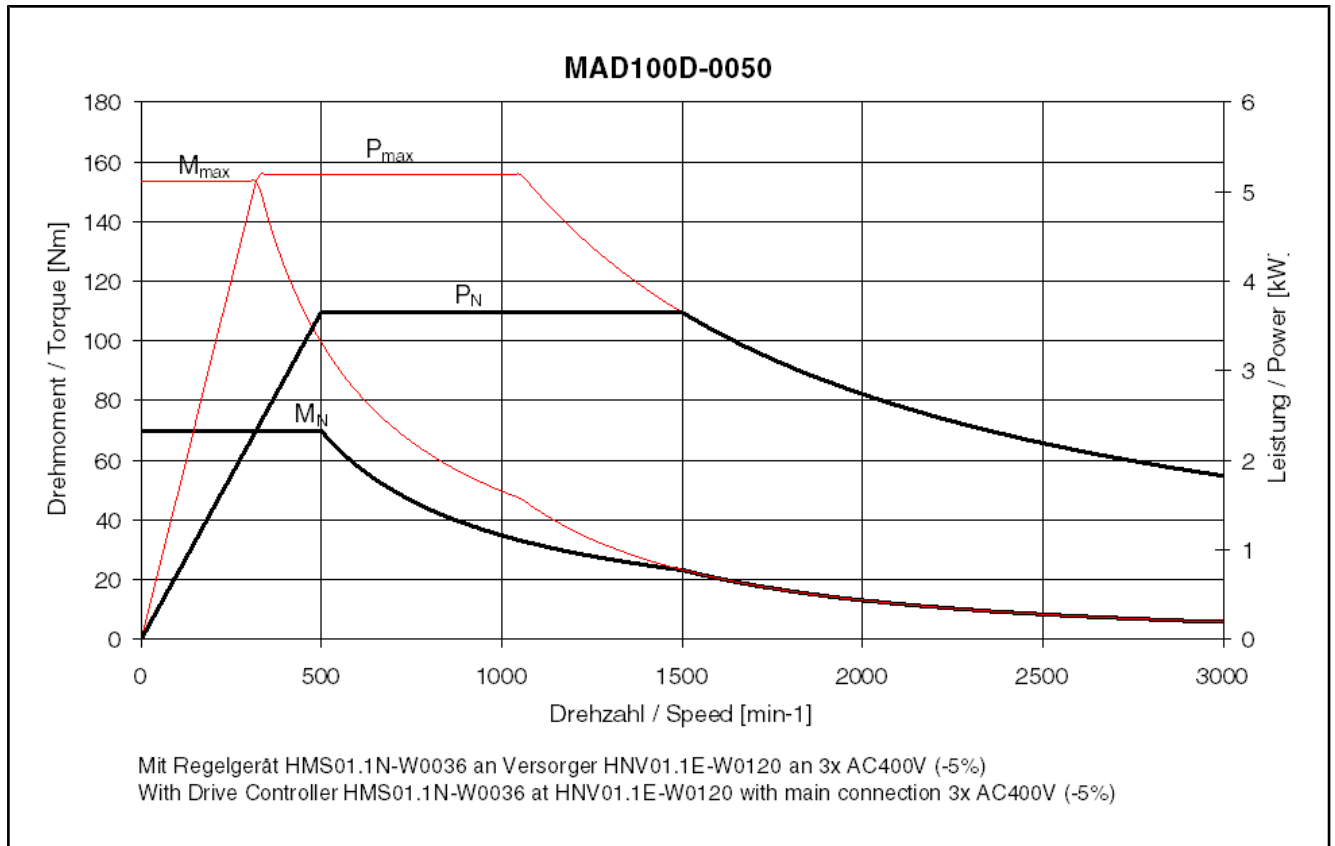

Fig.4-20: Motor characteristic curve of MAD100D-0050

Technical Data

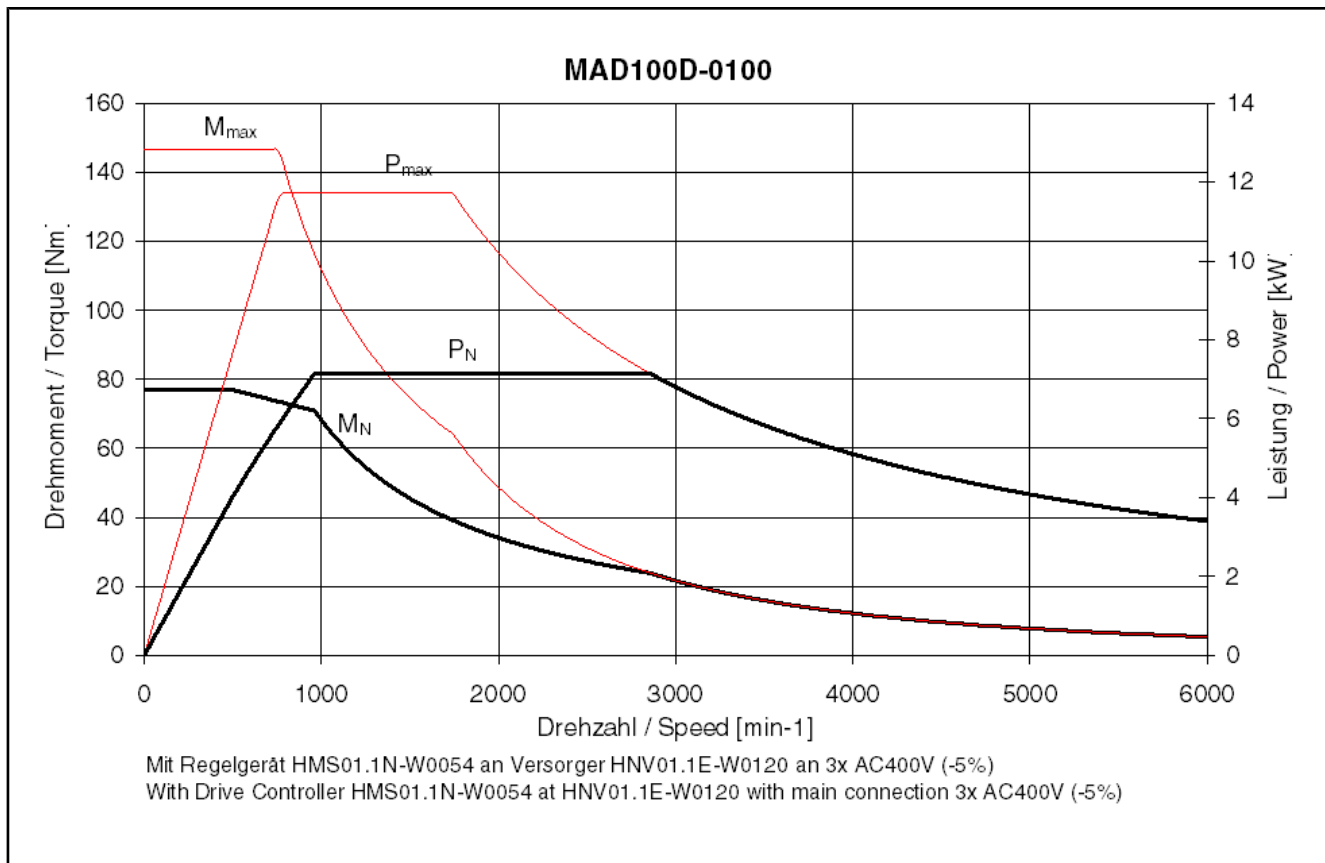

Fig.4-21: Motor characteristic curve of MAD100D-0100

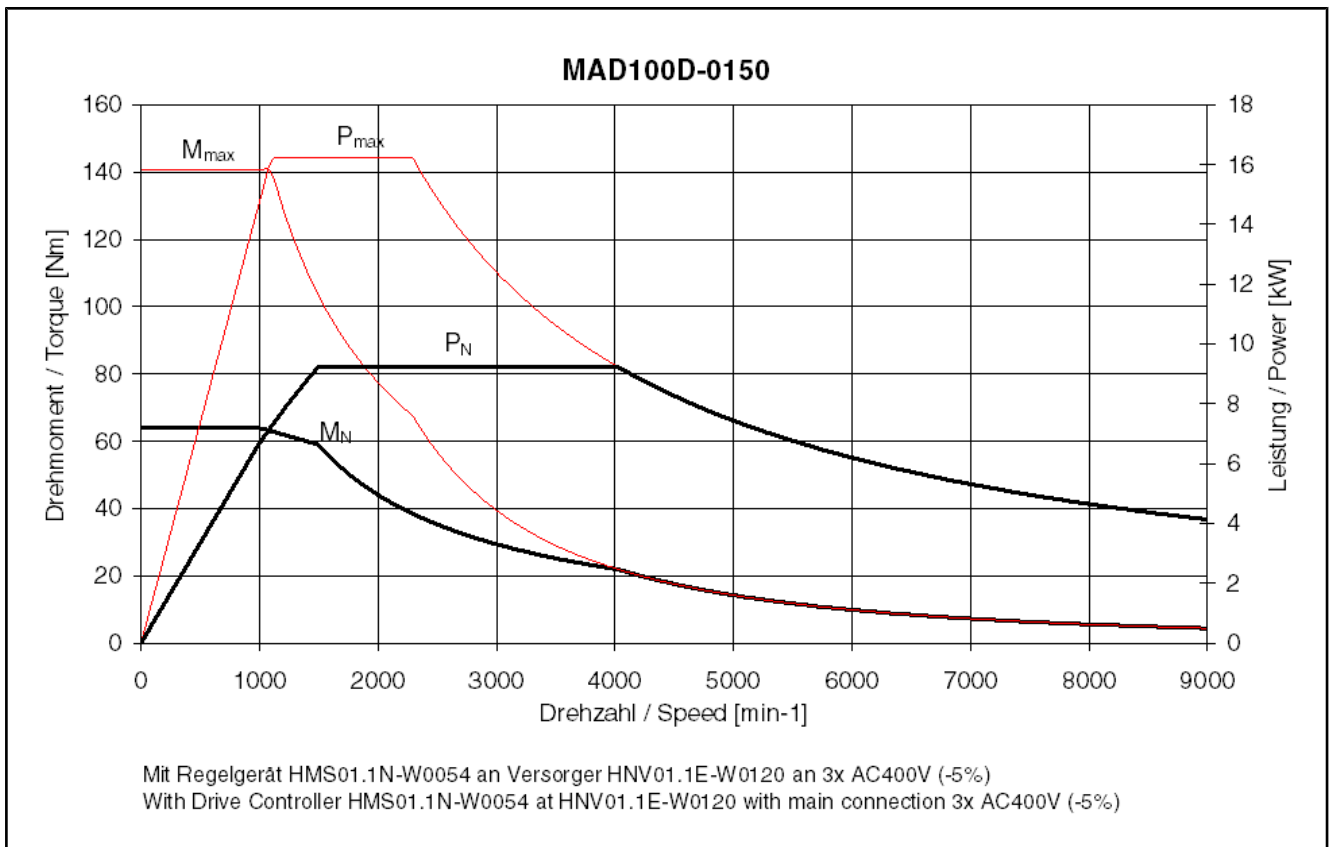

Fig.4-22: Motor characteristic curve of MAD100D-0150

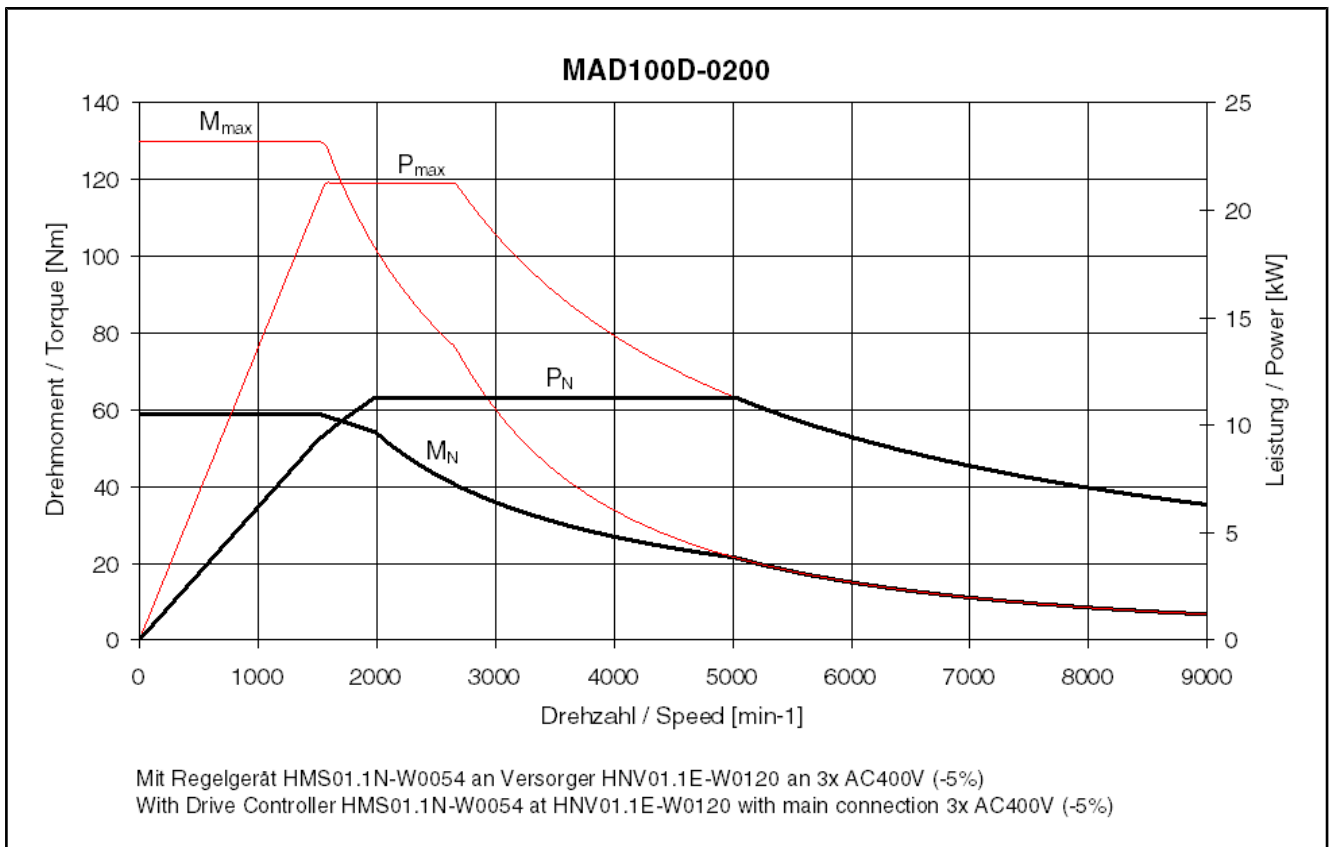

Fig.4-23: Motor characteristic curve of MAD100D-0200

Technical Data

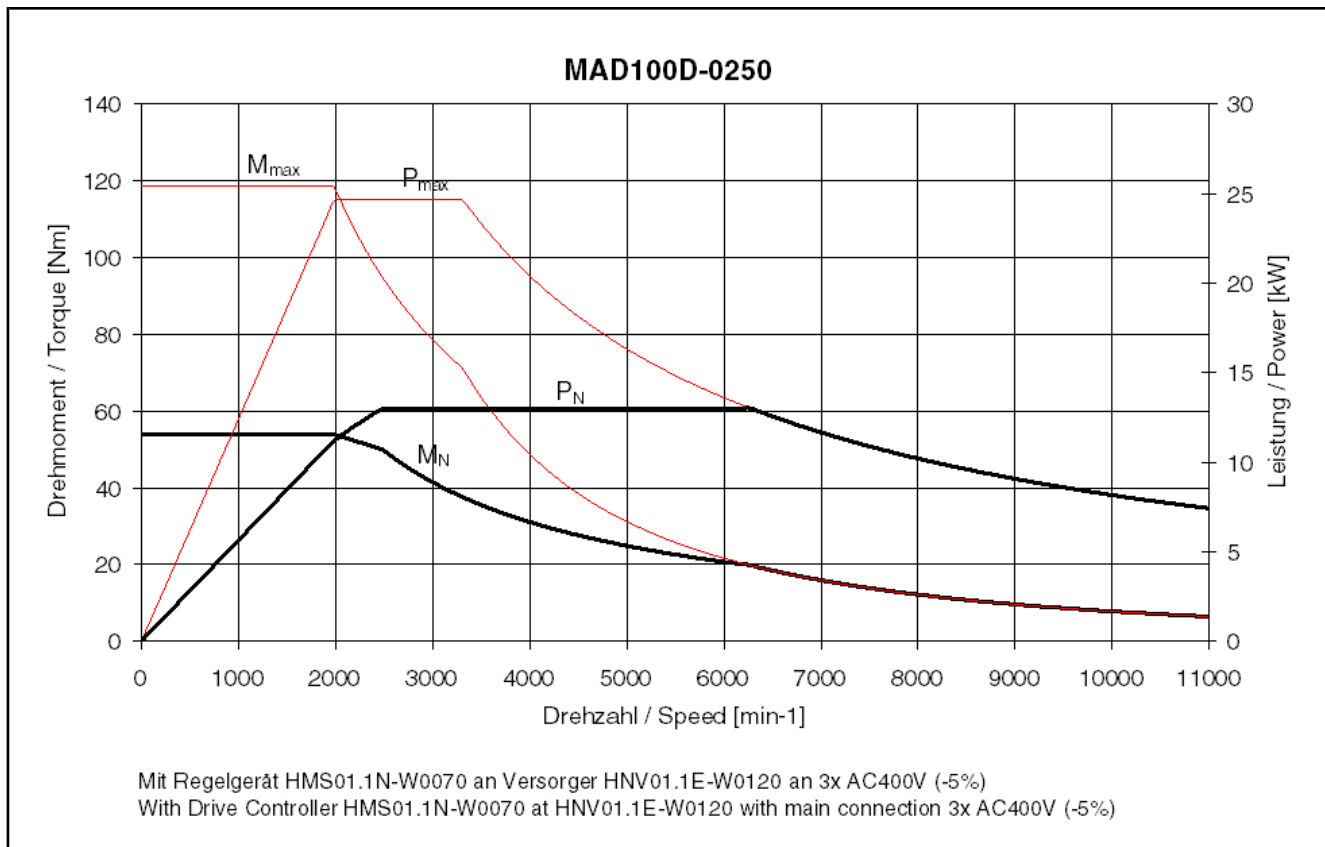

Fig.4-24: Motor characteristic curve of MAD100D-0250

4.3.7 Motor Fan MAD100

Motor fan MAD100 - electrical data

Designation	Symbol	Unit	Value	
Voltage type		-	3~ AC	
Air flow direction		-	B ⇒ A	
Mean volume flow		m ³ /h	360.0	
Nominal voltage	U _N	V	400	480
Nominal frequency	f	Hz	50 / 60	
Fan current ¹⁾	I _N	A	0.11 / 0.10	0.15 / 0.11
Blocking current	I _{block}	A	0.27 / 0.26	0.32 / 0.31
Power consumption	S _N	VA	76.20 / 70.00	125.00 / 91.50
Last revision: 2010-02-11				

1) Fan current monitoring should start at I_N + 20%.

Fig.4-25: Data sheet of motor fan MAD100

4.3.8 Holding Brake MAD/MAF100 (Optional)

Data sheet - holding brake MAD/MAF100

Designation	Symbol	Unit	BRAKE 5 Electrically clamping	BRAKE 1 Electrically releasing
Holding torque	M ₄	Nm	30.0	24.0
Rated voltage	U _N	V	24	
Rated current	I _N	A	0.90	1.10
Holding brake moment of inertia	J _{br}	kg*m ²	0.000529	0.000556
Connection time	t ₁	ms	42	30
Disconnection time	t ₂	ms	50	90
Maximum holding brake speed	n _{Br_max}	min ⁻¹	10000	
Last revision: 2006-10-23				

Fig.4-26: Technical data of holding brake MAD/MAF100 (optional)

Technical Data

4.4 Technical Data of MAD130

4.4.1 Data Sheet of MAD130B

Parameter	Symbol	Unit	MAD130B				
			0050	0100	0150	0200	0250
Rated torque ¹⁾	M_N	Nm	95.0	100.0	85.0	80.0	75.0
Rated power	P_N	kW	5.00	10.50	13.35	16.80	19.60
Rated current	I_N	A	12.8	26.9	34.9	43.0	47.2
Rated speed	n_N	1/min	500	1,000	1,500	2,000	2,500
Key speed	n_1	1/min	500		1,000	1,500	2,000
Maximum speed with bearing A	n_{max}	1/min	3,000	6,000	7,500		
Maximum speed with bearing H	n_{max}	1/min	3,000	6,000	9,000	10,000	
Maximum speed with bearing N	n_{max}	1/min	3,000	6,000	7,500		
Maximum speed with bearing V	n_{max}	1/min	3,000	6,000	7,500		
Maximum torque	M_{max}	Nm	208.8	230.0	200.0	187.2	176.5
Maximum power	P_{S6max}	kW	10.25	21.53	27.37	34.44	40.18
Maximum current	$I_{max(eff)}$	A	25.4	53.7	71.0	80.8	83.3
Continuous torque at standstill	M_{n1}	Nm	94.8	110.0	95.0	85.0	80.0
Continuous current at standstill	I_{n1}	A	12.8	28.7	37.4	44.5	47.2
Torque constant at 20 °C	K_{M-N}	Nm/A	8.49	4.79	3.07	2.47	2.15
Thermal time constant	$T_{th,nenn}$	min	20.0				
Cycle duration (S6 - 44%)	T_C	min	10				
Discharge capacity of the component	C_{ab}	nF	16.0	15.8		16.1	17.4
Number of pole pairs	p	--	3				
Power wire cross-section	A	mm ²	1.5	4.0	6.0	10.0	
Mass	m_{mot}	kg	105.2				
Rotor moment of inertia	J_{rot}	kg * m ²	0.0840000				
Sound pressure level	L_P	dB[A]	70 (+3)				
Ambient air temperature during operation	T_{um}	°C	0...+40				
Insulation class according to DIN EN 60034-1	I.CL.	-	155				

Last revision: 2009-07-15

1) Please note the information on the specified parameters at the beginning of this chapter

Fig.4-27: MAD130B - Technical data

4.4.2 Motor Characteristic Curves of MAD130B

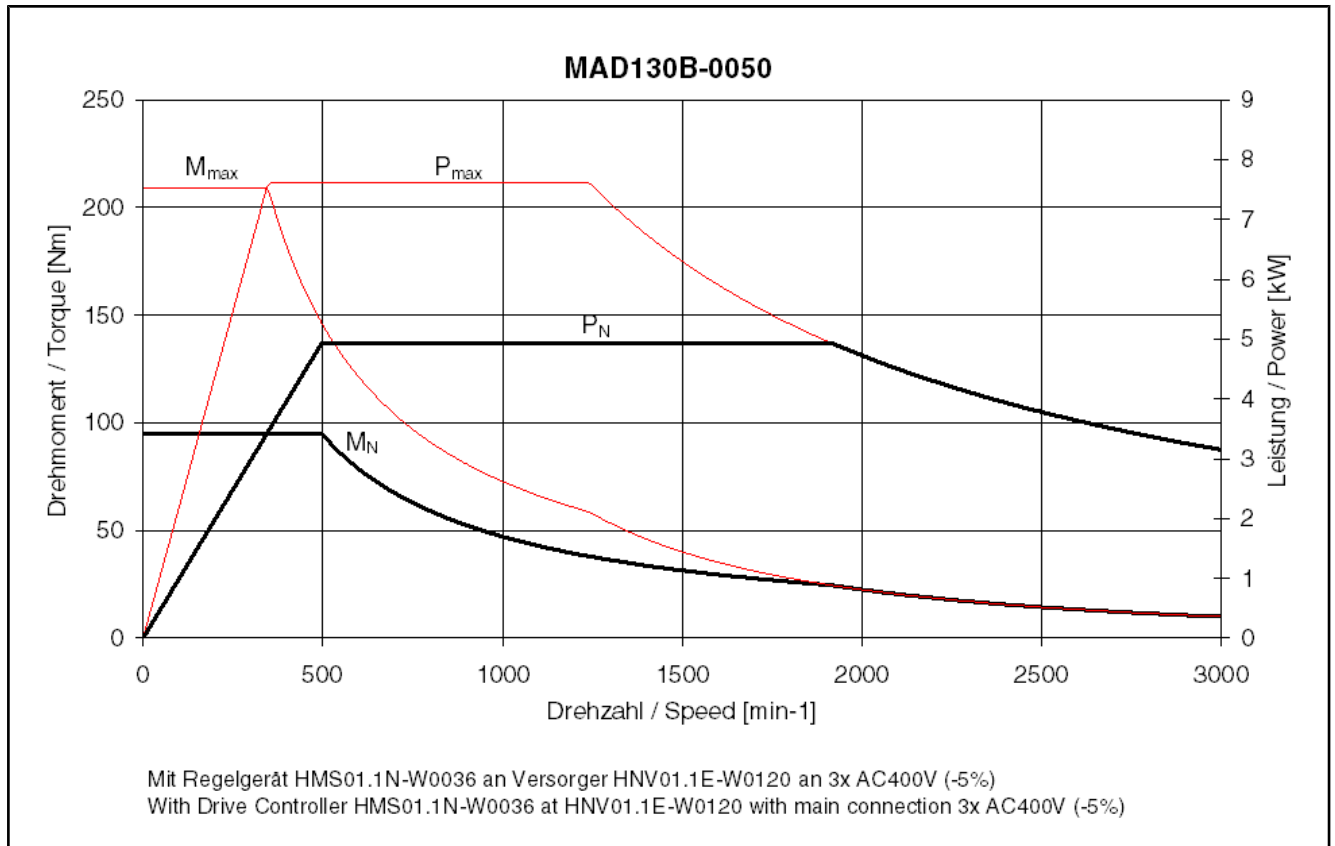

Fig.4-28: Motor characteristic curve of MAD130B-0050

Technical Data

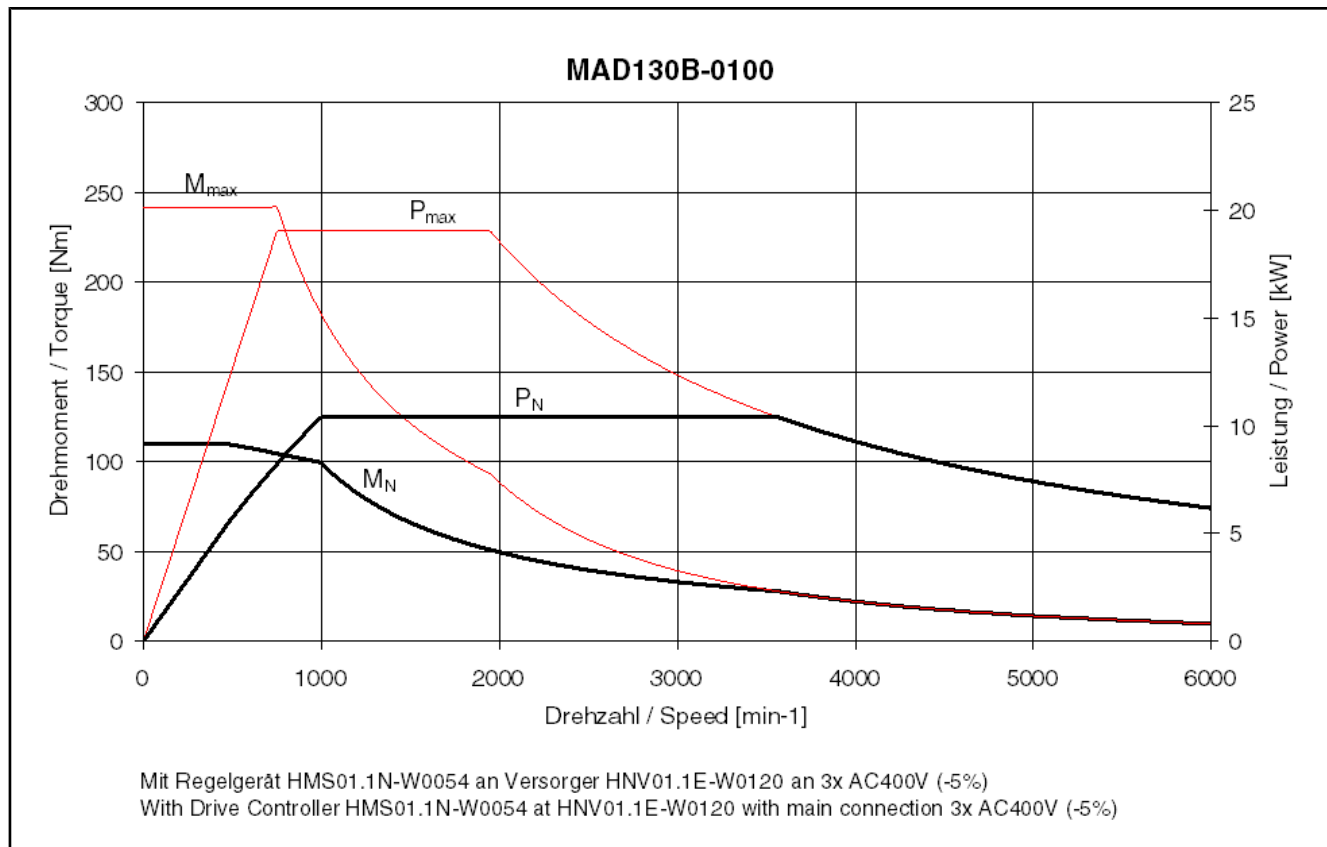

Fig.4-29: Motor characteristic curve of MAD130B-0100

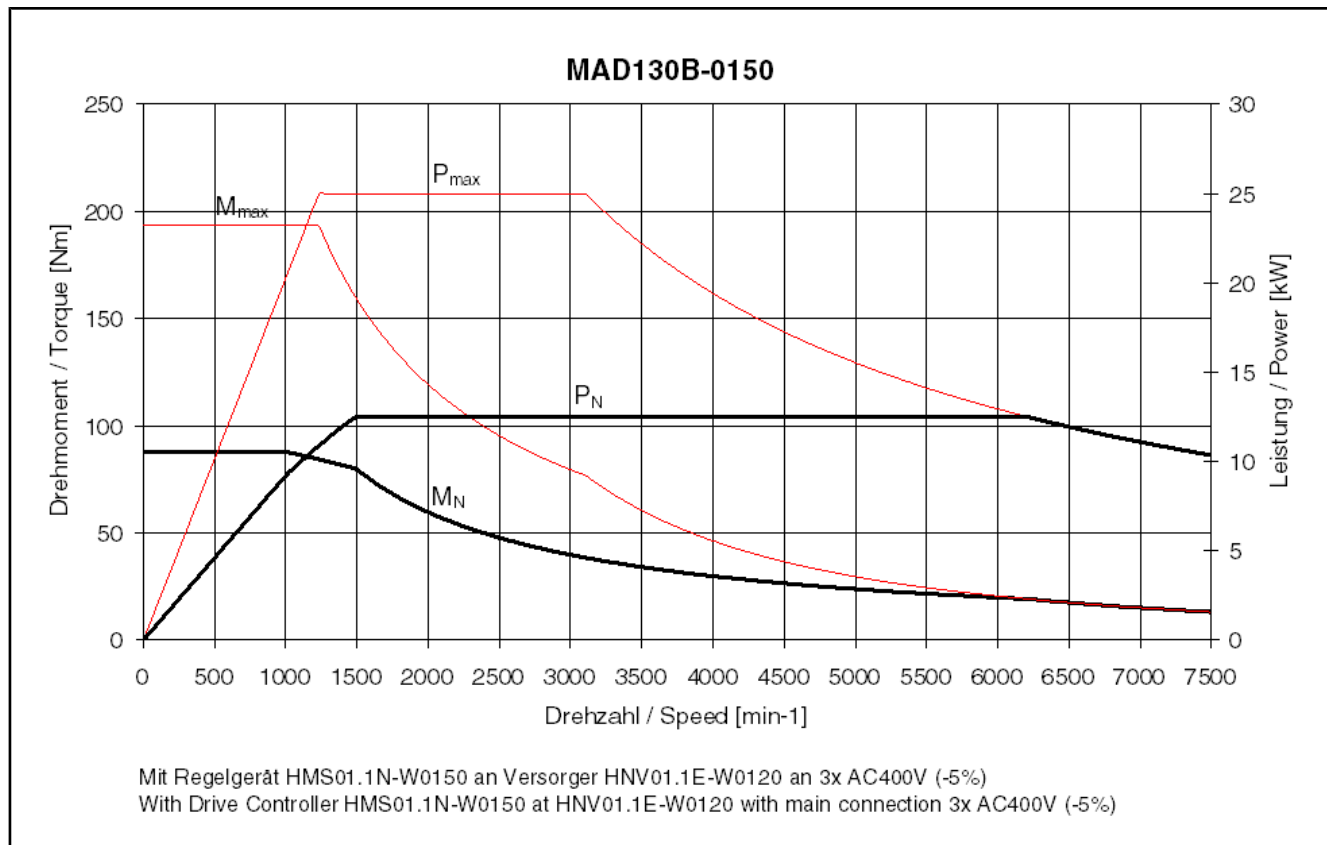

Fig.4-30: Motor characteristic curve of MAD130B-0150

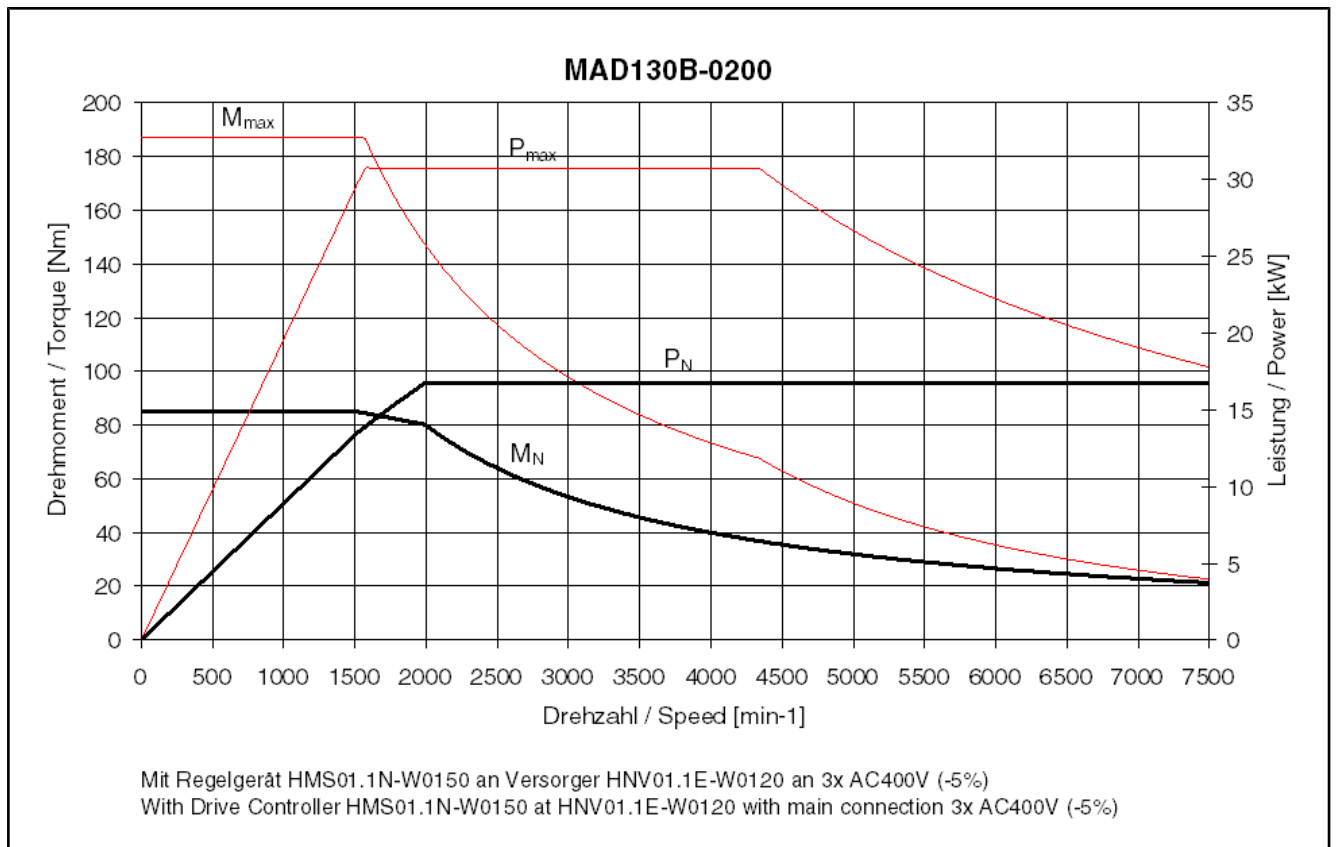

Fig.4-31: Motor characteristic curve of MAD130B-0200

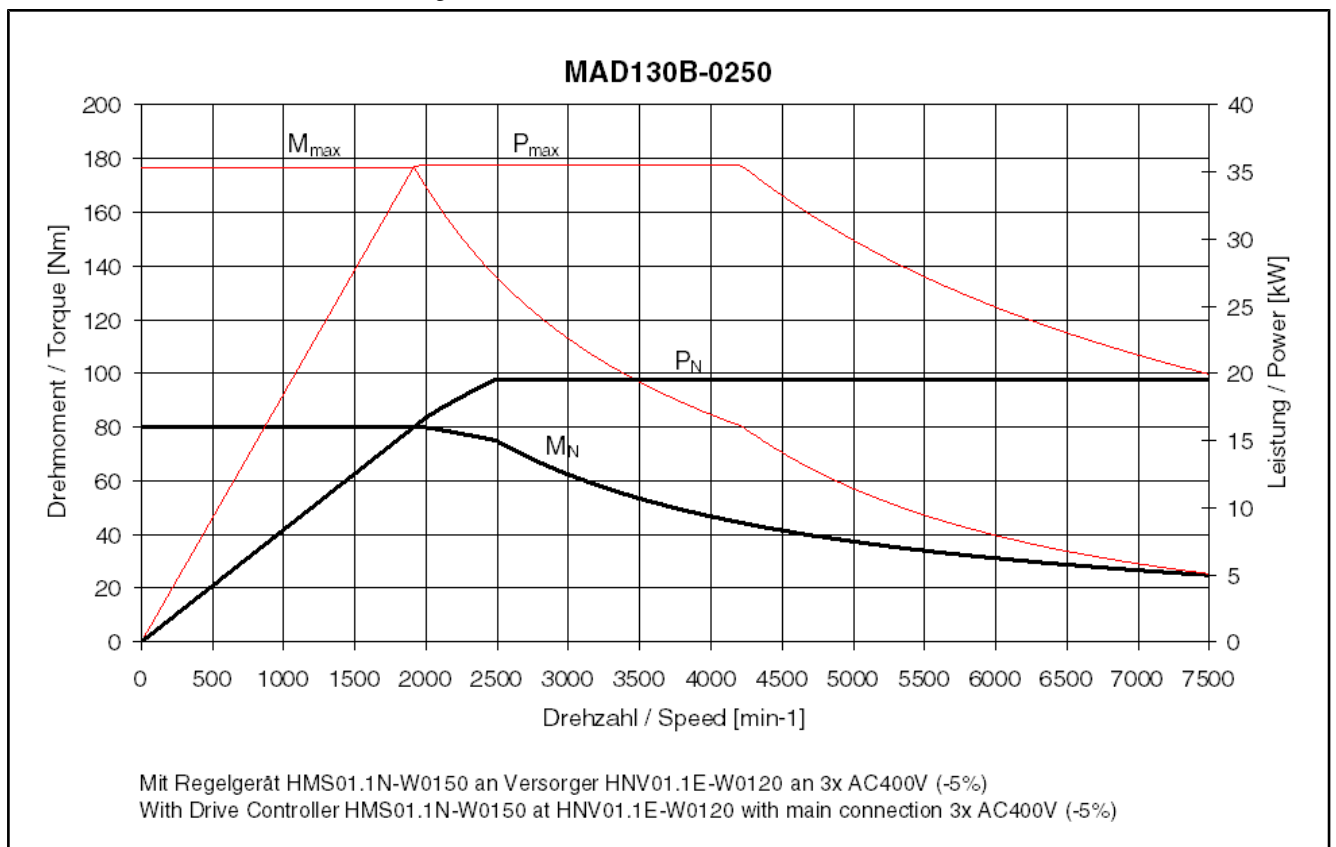

Fig.4-32: Motor characteristic curve of MAD130B-0250

Technical Data

4.4.3 Data Sheet of MAD130C

Parameter	Symbol	Unit	MAD130C				
			0050	0100	0150	0200	0250
Rated torque ¹⁾	M_N	Nm	140.0	125.0	117.0	110.0	100.0
Rated power	P_N	kW	7.30	13.09	18.40	23.00	26.20
Rated current	I_N	A	19.7	36.2	48.9	57.0	62.0
Rated speed	n_N	1/min	500	,1000	1,500	2,000	2,500
Key speed	n_1	1/min	500		1,000	1,500	2,000
Maximum speed with bearing A	n_{max}	1/min	3,000	6,000	7,500		
Maximum speed with bearing H	n_{max}	1/min	3,000	6,000	9,000	10,000	
Maximum speed with bearing N	n_{max}	1/min	3,000	6,000	7,500		
Maximum speed with bearing V	n_{max}	1/min	3,000	6,000	7,500		
Maximum torque	M_{max}	Nm	307.9	305.0	275.2	252.9	250.0
Maximum power	P_{S6max}	kW	14.97	26.83	37.72	47.15	53.70
Maximum current	$I_{max(eff)}$	A	35.4	73.8	93.3	106.7	126.6
Continuous torque at standstill	M_{n1}	Nm	139.9	140.0	125.0	115.0	110.0
Continuous current at standstill	I_{n1}	A	19.7	38.5	51.0	59.6	65.6
Torque constant at 20 °C	K_{M-N}	Nm/A	9.31	4.26	3.10	2.64	1.96
Thermal time constant	T_{th_nenn}	min	30.0				
Cycle duration (S6 - 44%)	T_C	min	10				
Discharge capacity of the component	C_{ab}	nF	20.0	20.9	20.5	19.3	20.1
Number of pole pairs	p	--	3				
Power wire cross-section	A	mm ²	2.5	6.0	10.0	16.0	
Mass	m_{mot}	kg	124.0				
Rotor moment of inertia	J_{rot}	kg * m ²	0.1080000				
Sound pressure level	L_P	dB[A]	70 (+3)				
Ambient air temperature during operation	T_{um}	°C	0...+40				
Insulation class according to DIN EN 60034-1	I.CL.	-	155				

Last revision: 2008-08-06

1) Please note the information on the specified parameters at the beginning of this chapter
 Fig.4-33: MAD130C - Technical data

4.4.4 Motor Characteristic Curves of MAD130C

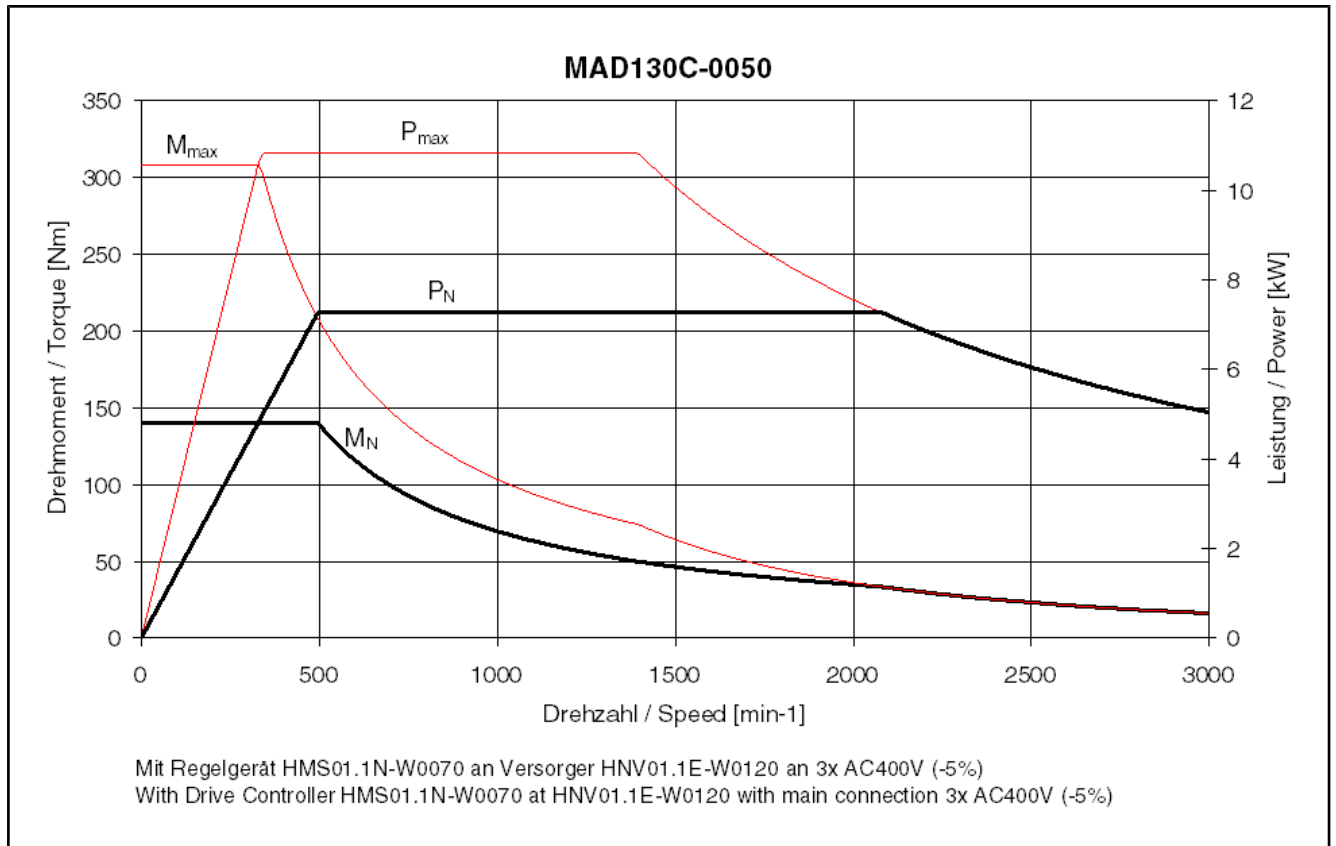

Fig.4-34: Motor characteristic curve of MAD130C-0050

Technical Data

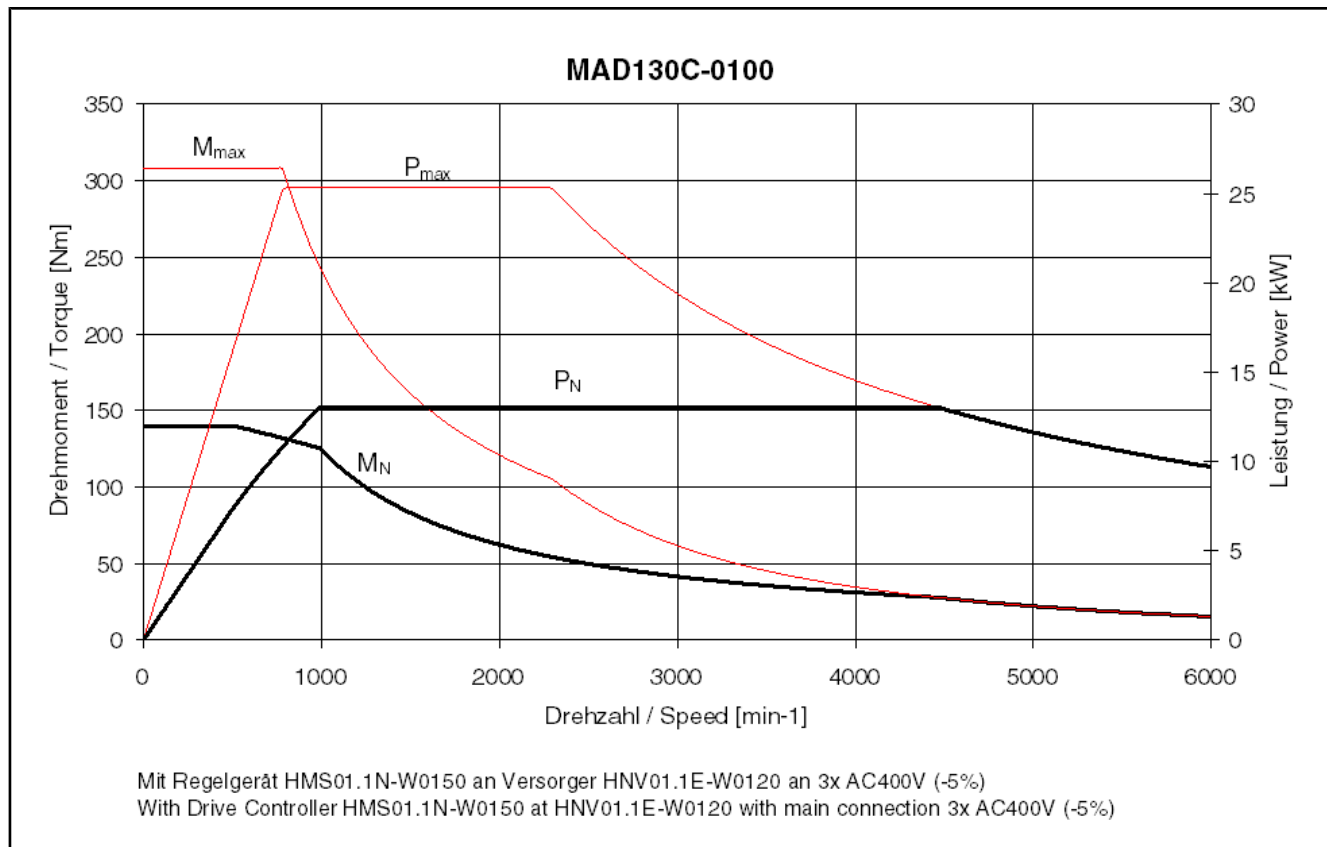

Fig.4-35: Motor characteristic curve of MAD130C-0100

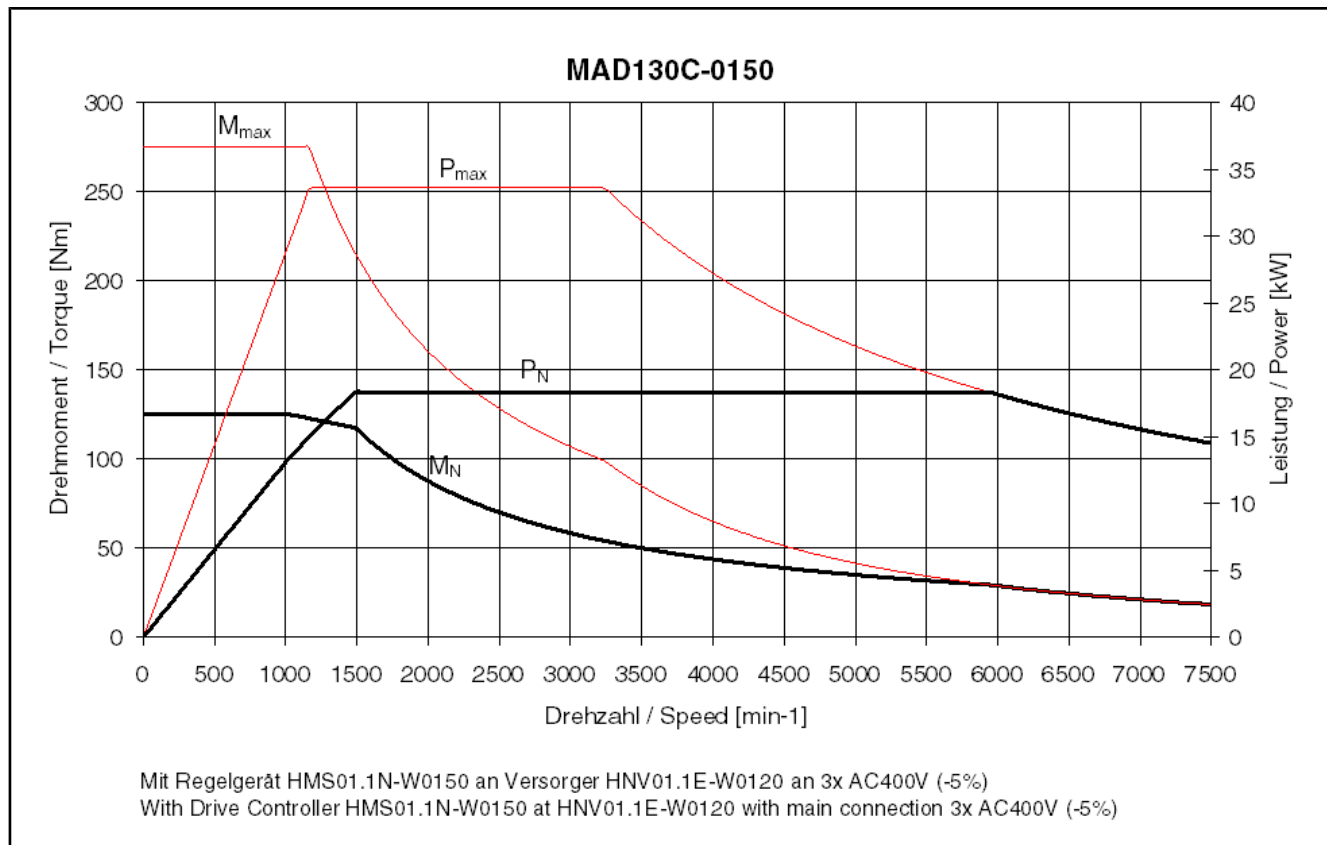

Fig.4-36: Motor characteristic curve of MAD130C-0150

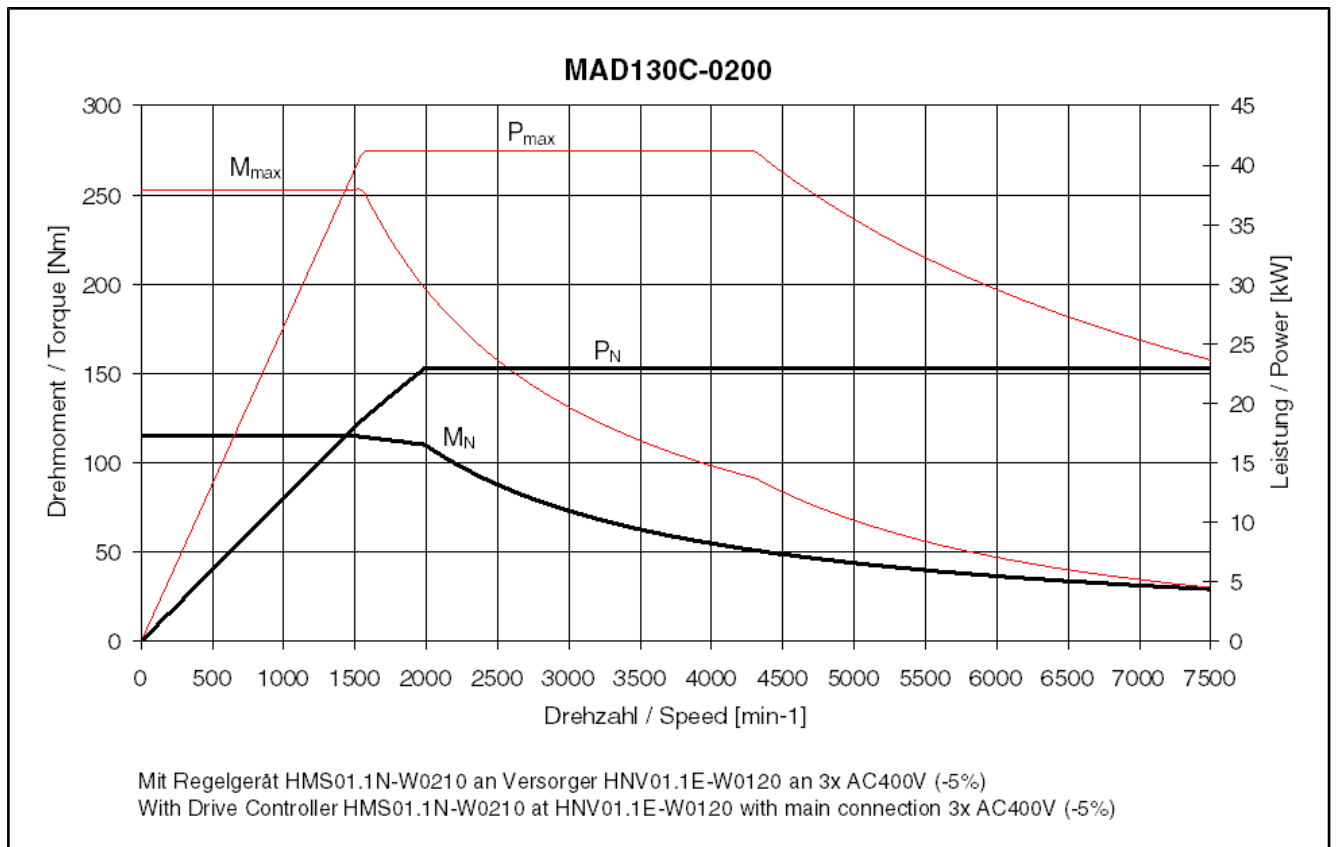

Fig.4-37: Motor characteristic curve of MAD130C-0200

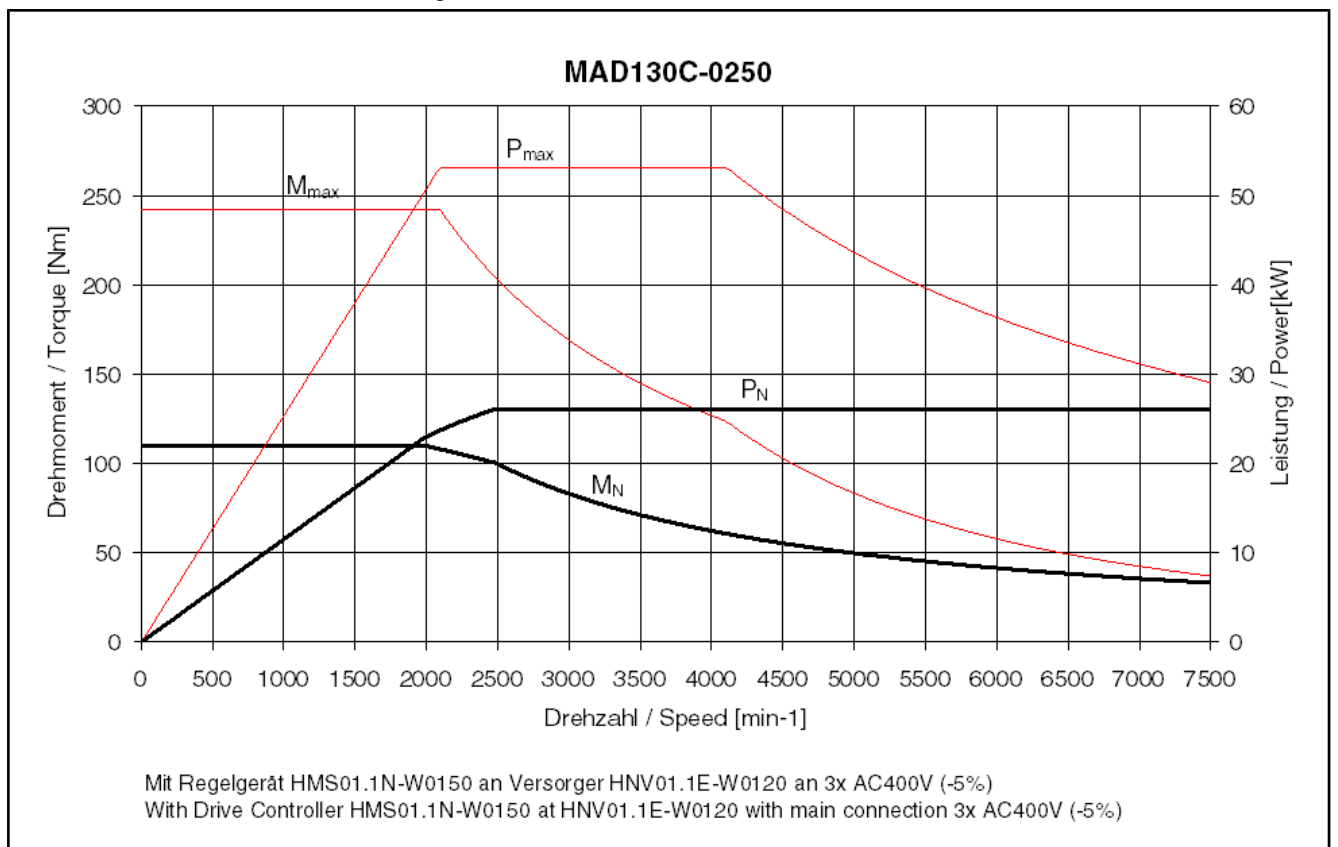

Fig.4-38: Motor characteristic curve of MAD130C-0250

Technical Data

4.4.5 Data Sheet of MAD130D

Parameter	Symbol	Unit	MAD130D				
			0050	0100	0150	0200	0250
Rated torque ¹⁾	M_N	Nm	180.0	170.0	155.0	150.0	120.0
Rated power	P_N	kW	9.40	17.80	24.30	31.40	
Rated current	I_N	A	24.2	43.7	61.5	71.3	72.0
Rated speed	n_N	1/min	500	1,000	1,500	2,000	2,500
Key speed	n_1	1/min	500		1,000	1,500	2,000
Maximum speed with bearing A	n_{max}	1/min	3,000	6,000	7,500		
Maximum speed with bearing H	n_{max}	1/min	3,000	6,000	9,000	10,000	
Maximum speed with bearing N	n_{max}	1/min	3,000	6,000	7,500		
Maximum speed with bearing V	n_{max}	1/min	3,000	6,000	7,500		
Maximum torque	M_{max}	Nm	395.6	417.8	374.6	340.7	310.0
Maximum power	P_{S6max}	kW	19.27	36.49	49.82	64.37	
Maximum current	$I_{max(eff)}$	A	47.0	93.4	123.0	137.0	123.4
Continuous torque at standstill	M_{n1}	Nm	179.8	190.0	170.0	155.0	130.0
Continuous current at standstill	I_{n1}	A	24.2	47.8	64.1	72.8	75.4
Torque constant at 20 °C	K_{M-N}	Nm/A	8.75	4.72	3.09	2.62	2.69
Thermal time constant	T_{th_nenn}	min	30.0				
Cycle duration (S6 - 44%)	T_C	min	10				
Discharge capacity of the component	C_{ab}	nF	27.5	27.3	30.5	27.5	26.4
Number of pole pairs	p	--	3				
Power wire cross-section	A	mm ²	4.0	10.0	16.0		25.0
Mass	m_{mot}	kg	165.0				
Rotor moment of inertia	J_{rot}	kg * m ²	0.1640000				
Sound pressure level	L_P	dB[A]	70 (+3)				
Ambient air temperature during operation	T_{um}	°C	0...+40				
Insulation class according to DIN EN 60034-1	I.CL.	-	155				

Last revision: 2008-08-05

1) Please note the information on the specified parameters at the beginning of this chapter

Fig.4-39: MAD130D - Technical data

4.4.6 Motor Characteristic Curves of MAD130D

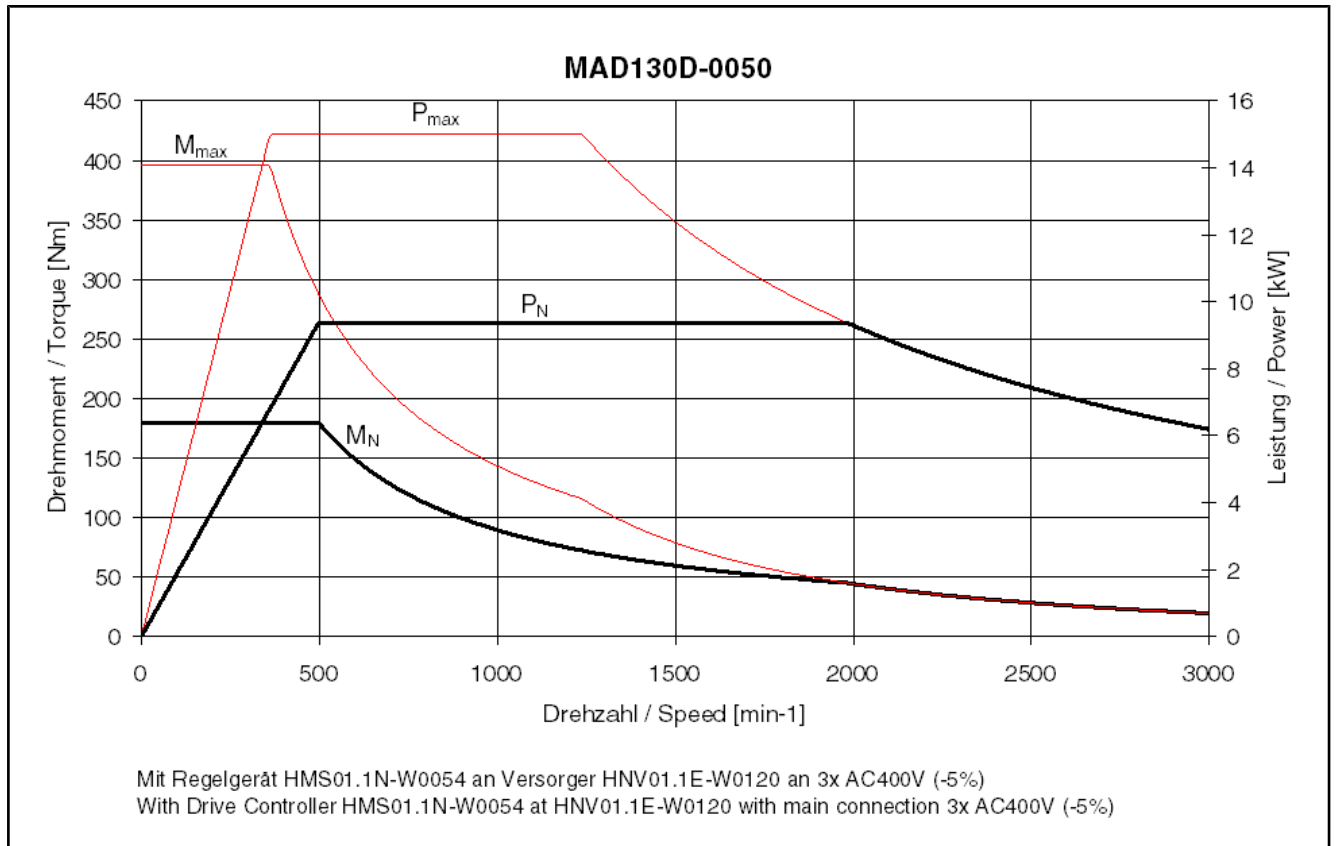

Fig.4-40: Motor characteristic curve of MAD130D-0050

Technical Data

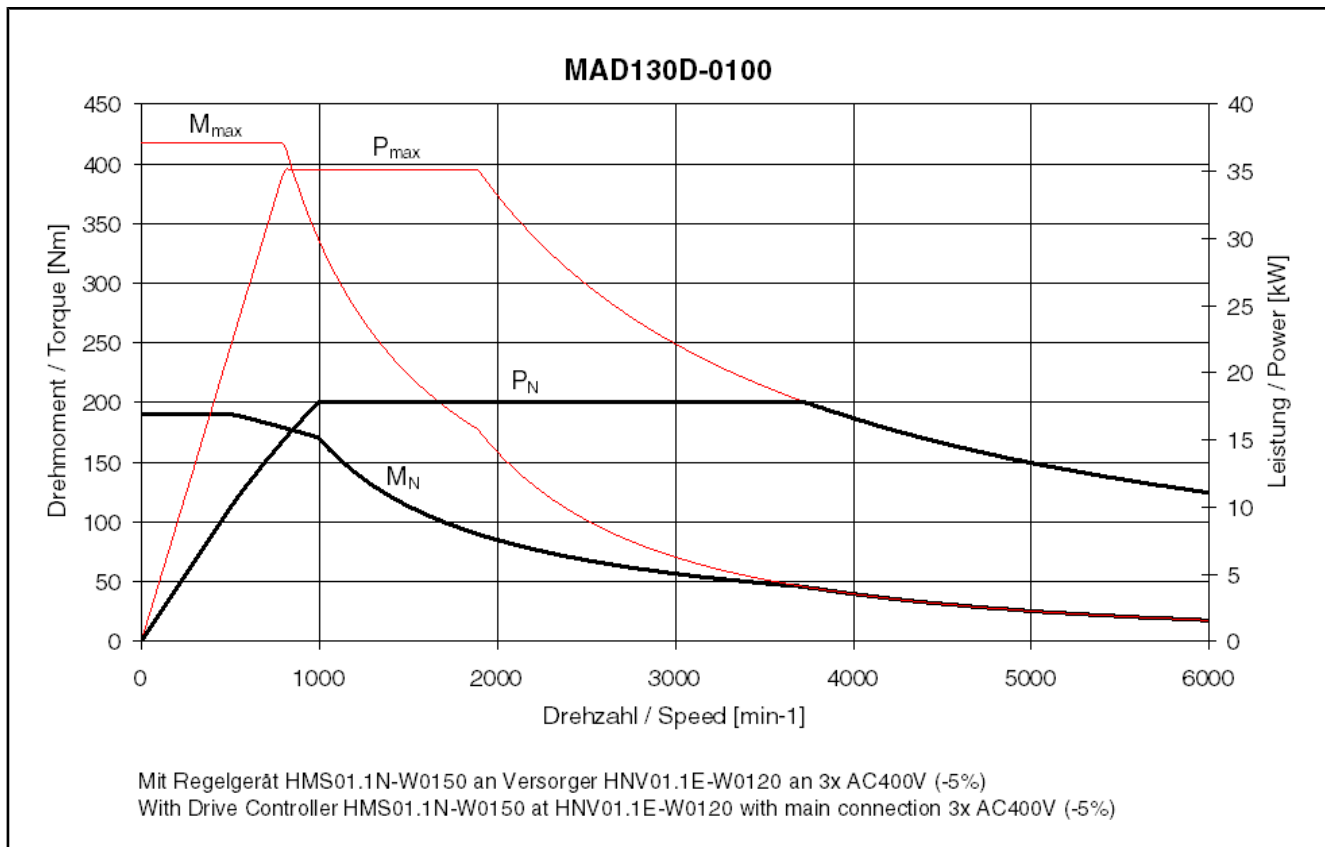

Fig.4-41: Motor characteristic curve of MAD130D-0100

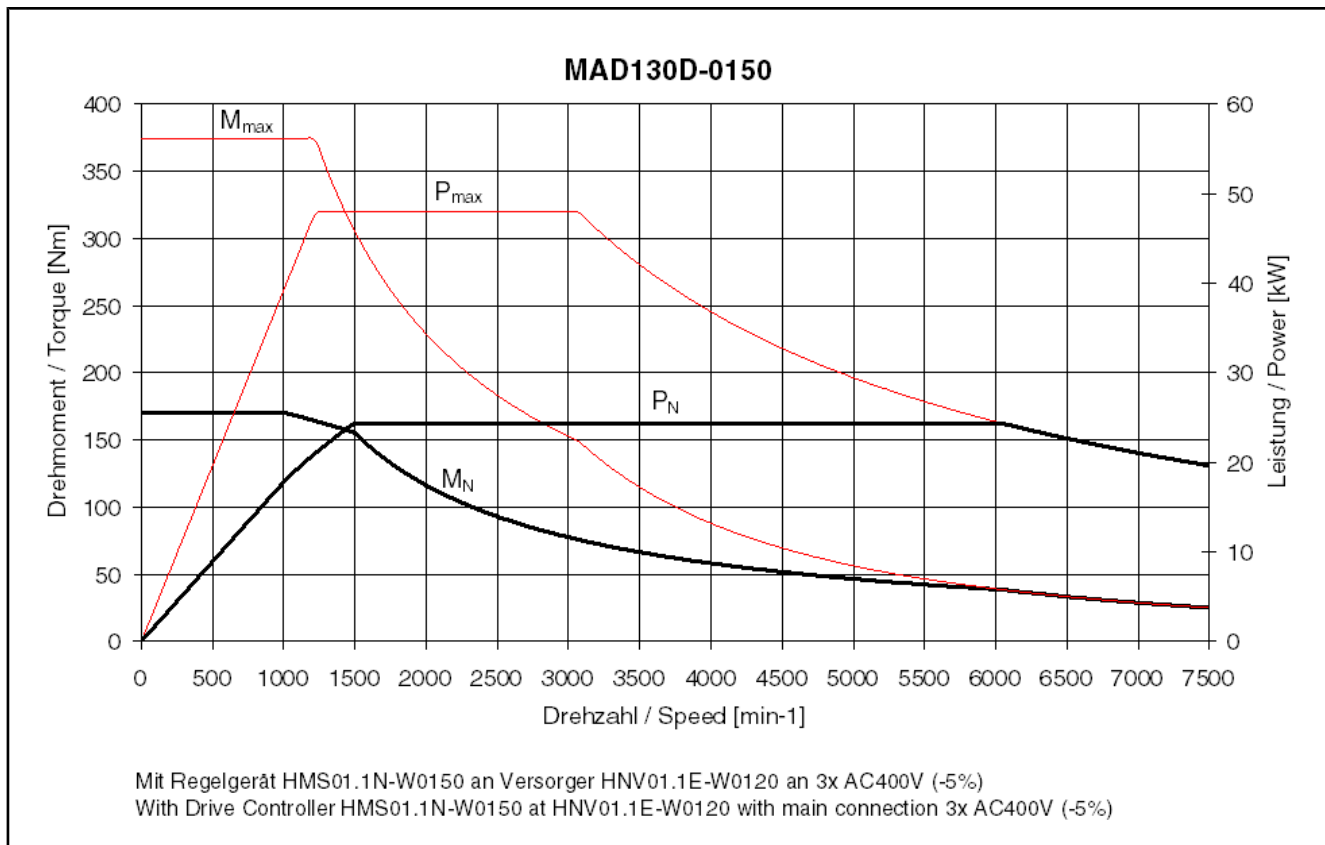

Fig.4-42: Motor characteristic curve of MAD130D-0150

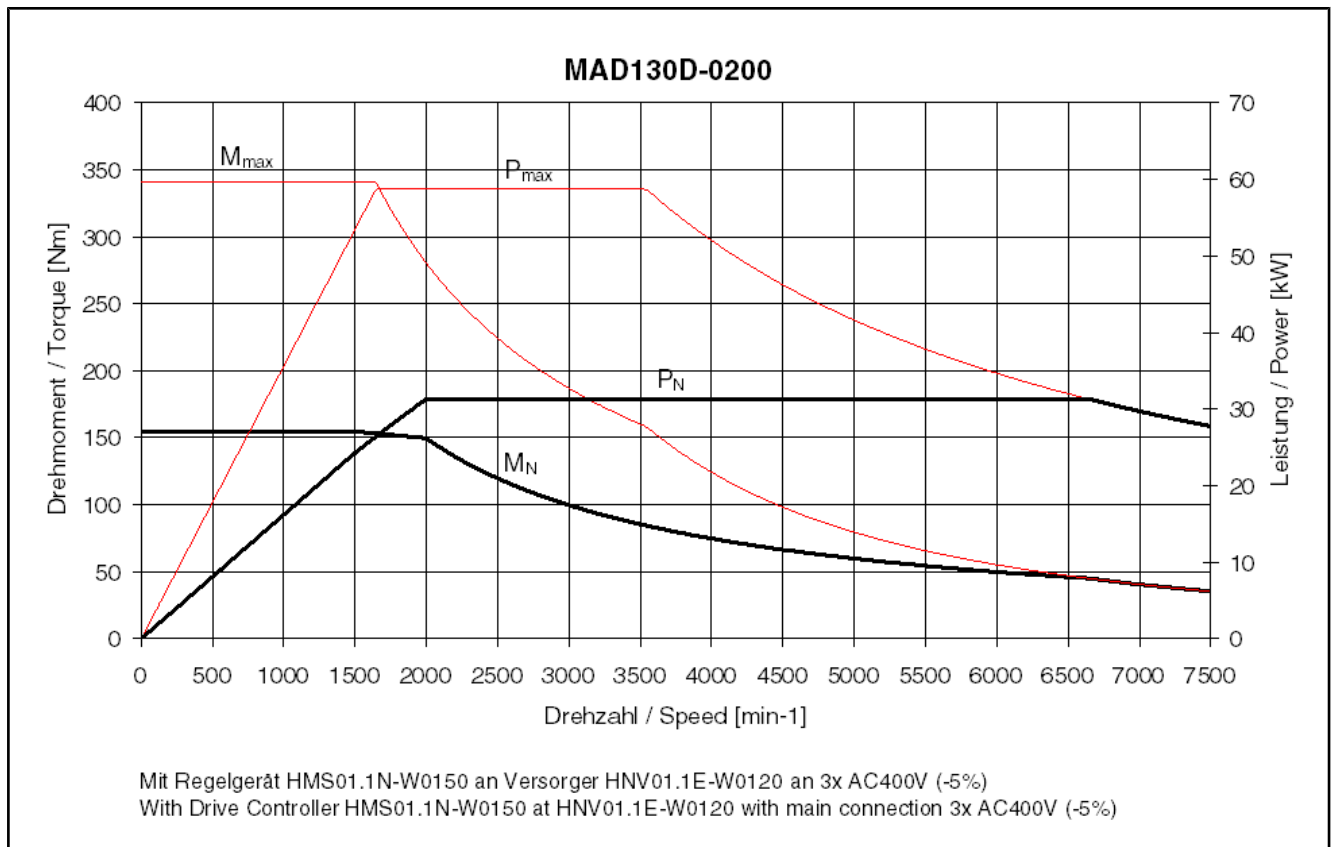

Fig.4-43: Motor characteristic curve of MAD130D-0200

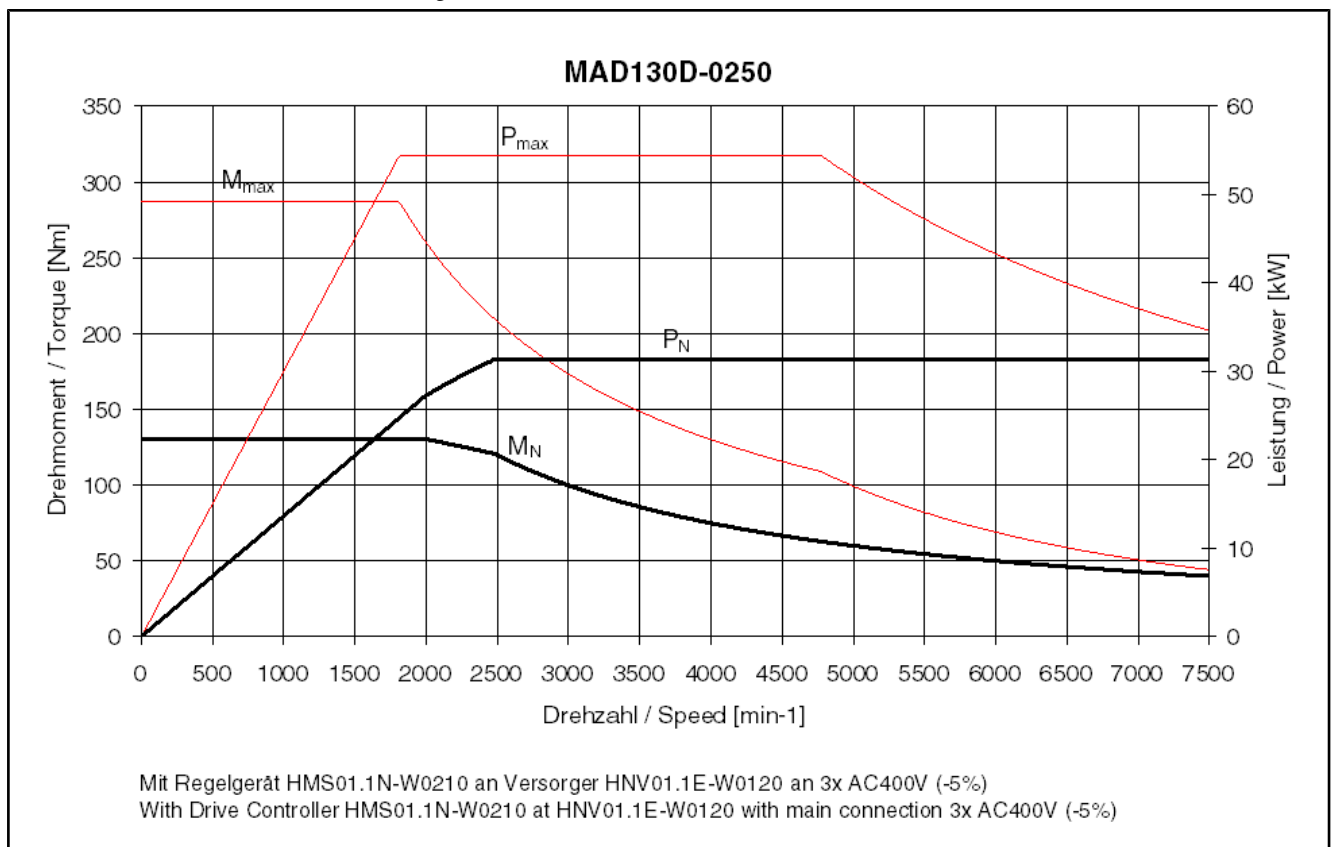

Fig.4-44: Motor characteristic curve of MAD130D-0250

Technical Data

4.4.7 Motor Fan MAD130**Motor fan MAD130 - electrical data**

Designation	Symbol	Unit	Value	
Voltage type		-	3~ AC	
Air flow direction		-	B ⇒ A	
Mean volume flow		m ³ /h	350.0	
Nominal voltage	U_N	V	400	480
Nominal frequency	f	Hz	50 / 60	
Fan current ¹⁾	I_N	A	0.19 / 0.28	0.18 / 0.26
Blocking current	I_{block}	A	0.55 / 0.47	0.62 / 0.55
Power consumption	S_N	VA	132.00 / 197.45	151.30 / 217.82

Last revision: 2010-02-02

1) Fan current monitoring should start at $I_N + 20\%$.

Fig.4-45: Data sheet of motor fan MAD130

4.4.8 Holding Brake MAD/MAF130 (Optional)**Data sheet - holding brake MAD/MAF130**

Designation	Symbol	Unit	BRAKE 5 Electrically clamping	BRAKE 1 Electrically releasing
Holding torque	M_4	Nm	100.0	80.0
Rated voltage	U_N	V	24	
Rated current	I_N	A	1.50	1.60
Holding brake moment of inertia	J_{br}	kg*m ²	0.003180	0.001710
Connection time	t_1	ms	110	50
Disconnection time	t_2	ms	65	140
Maximum holding brake speed	n_{Br_max}	min ⁻¹	8,000	

Last revision: 2006-10-23

Fig.4-46: Technical data of holding brake MAD/MAF130 (optional)

4.5 Technical Data of MAD160

4.5.1 Data Sheet of MAD160B

Parameter	Symbol	Unit	MAD160B			
			0050	0100	0150	0200
Rated torque ¹⁾	M_N	Nm	220.0	200.0	190.0	160.0
Rated power	P_N	kW	11.50	20.94	29.86	33.50
Rated current	I_N	A	26.1	50.8	61.6	75.8
Rated speed	n_N	1/min	500	1,000	1,500	2,000
Key speed	n_1	1/min	500		1,000	1,500
Maximum speed with bearing A	n_{max}	1/min	3,000	6,000		
Maximum speed with bearing H	n_{max}	1/min	3,000	6,000	8,000	
Maximum speed with bearing N	n_{max}	1/min	3,000	6,000		
Maximum speed with bearing V	n_{max}	1/min	3,000	6,000		
Maximum torque	M_{max}	Nm	483.9	520.0	440.1	375.3
Maximum power	P_{S6max}	kW	23.58	58.00	61.20	68.68
Maximum current	$I_{max(eff)}$	A	51.7	110.0	132.2	157.4
Continuous torque at standstill	M_{n1}	Nm	220.0		200.0	170.0
Continuous current at standstill	I_{n1}	A	26.1	53.7	64.0	80.9
Torque constant at 20 °C	$K_{M,N}$	Nm/A	9.66	4.44	3.37	2.54
Thermal time constant	T_{th_nenn}	min	35.0			
Cycle duration (S6 - 44%)	T_C	min	10			
Discharge capacity of the component	C_{ab}	nF	25.5	35.0		34.4
Number of pole pairs	p	--	2			
Power wire cross-section	A	mm ²	4.0	10.0	16.0	25.0
Mass	m_{mot}	kg	201.0			
Rotor moment of inertia	J_{rot}	kg * m ²	0.2500000			
Sound pressure level	L_p	dB[A]	75 (+3)			
Ambient air temperature during operation	T_{um}	°C	0...+40			
Insulation class according to DIN EN 60034-1	I.CL.	-	155			

Last revision: 2010-10-28

1) Please note the information on the specified parameters at the beginning of this chapter
 Fig.4-47: MAD160B - Technical data

Technical Data

4.5.2 Motor Characteristic Curves of MAD160B

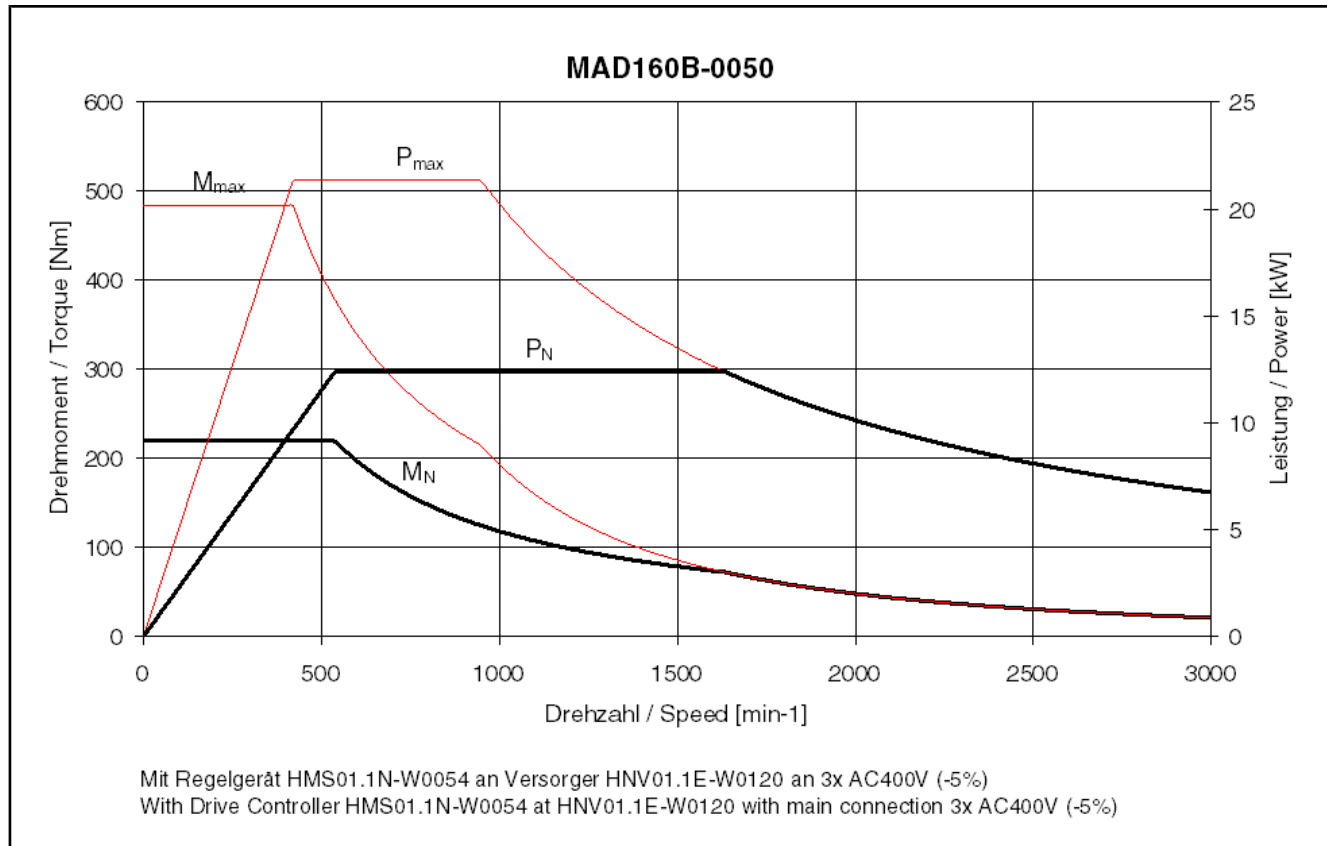

Fig.4-48: Motor characteristic curve of MAD160B-0050

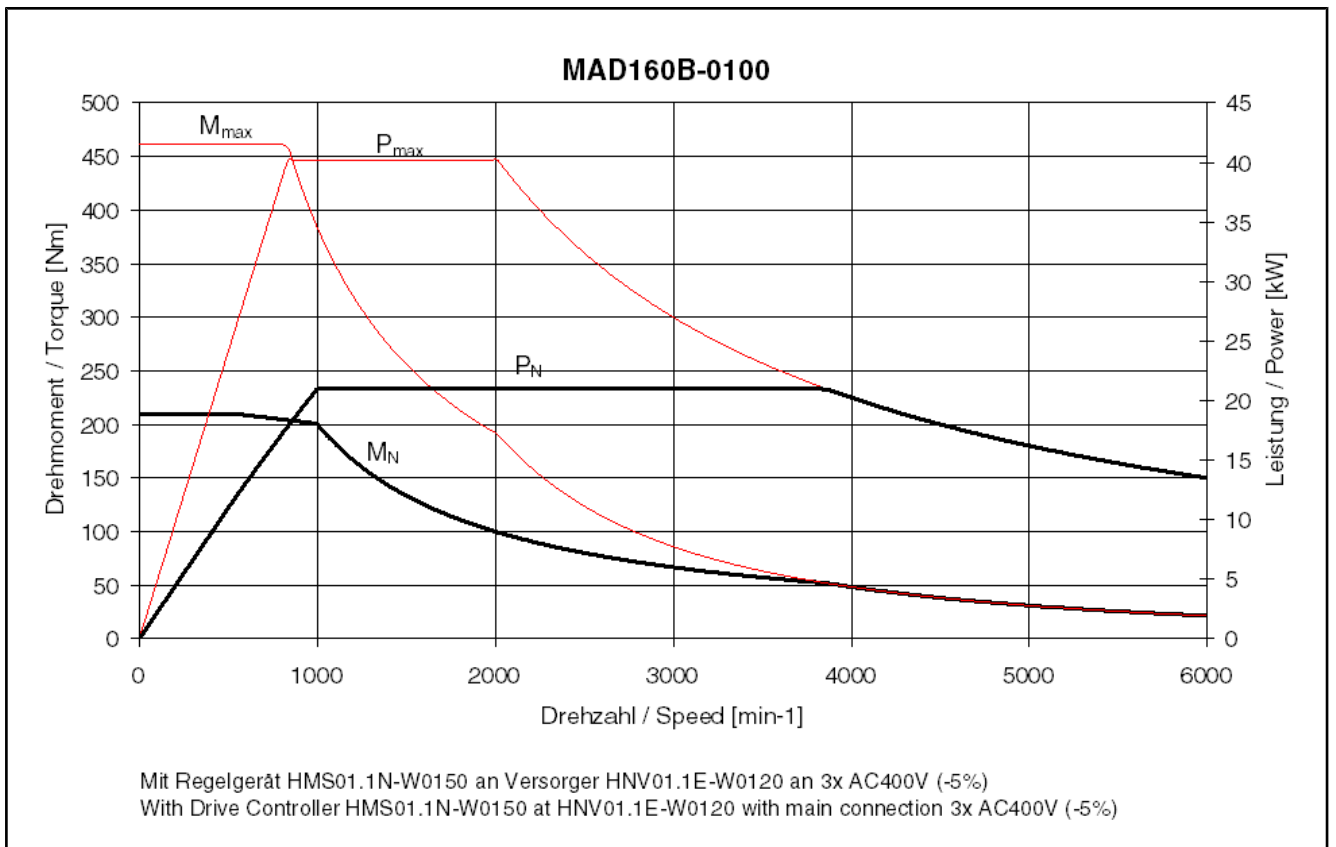

Fig.4-49: Motor characteristic curve of MAD160B-0100

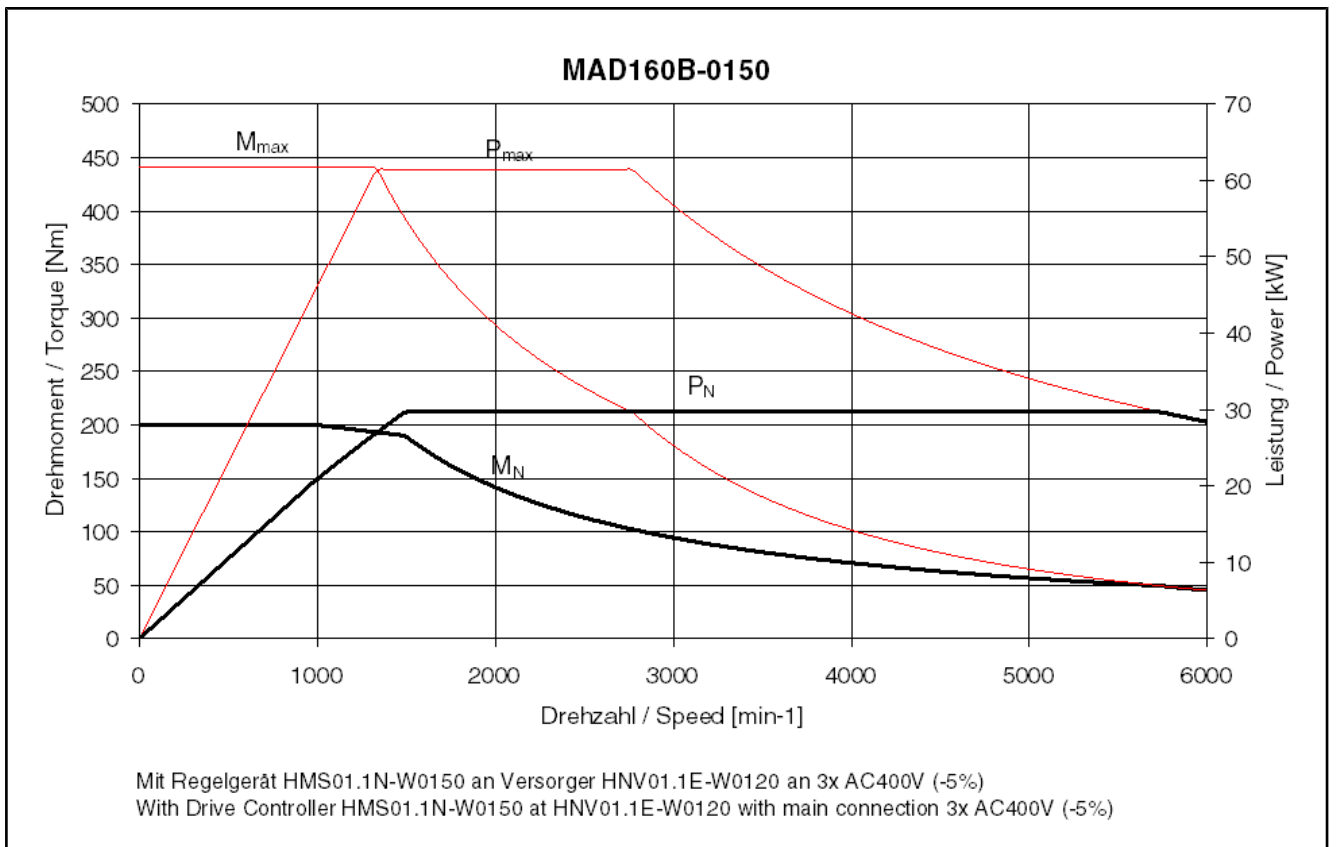

Fig.4-50: Motor characteristic curve of MAD160B-0150

Technical Data

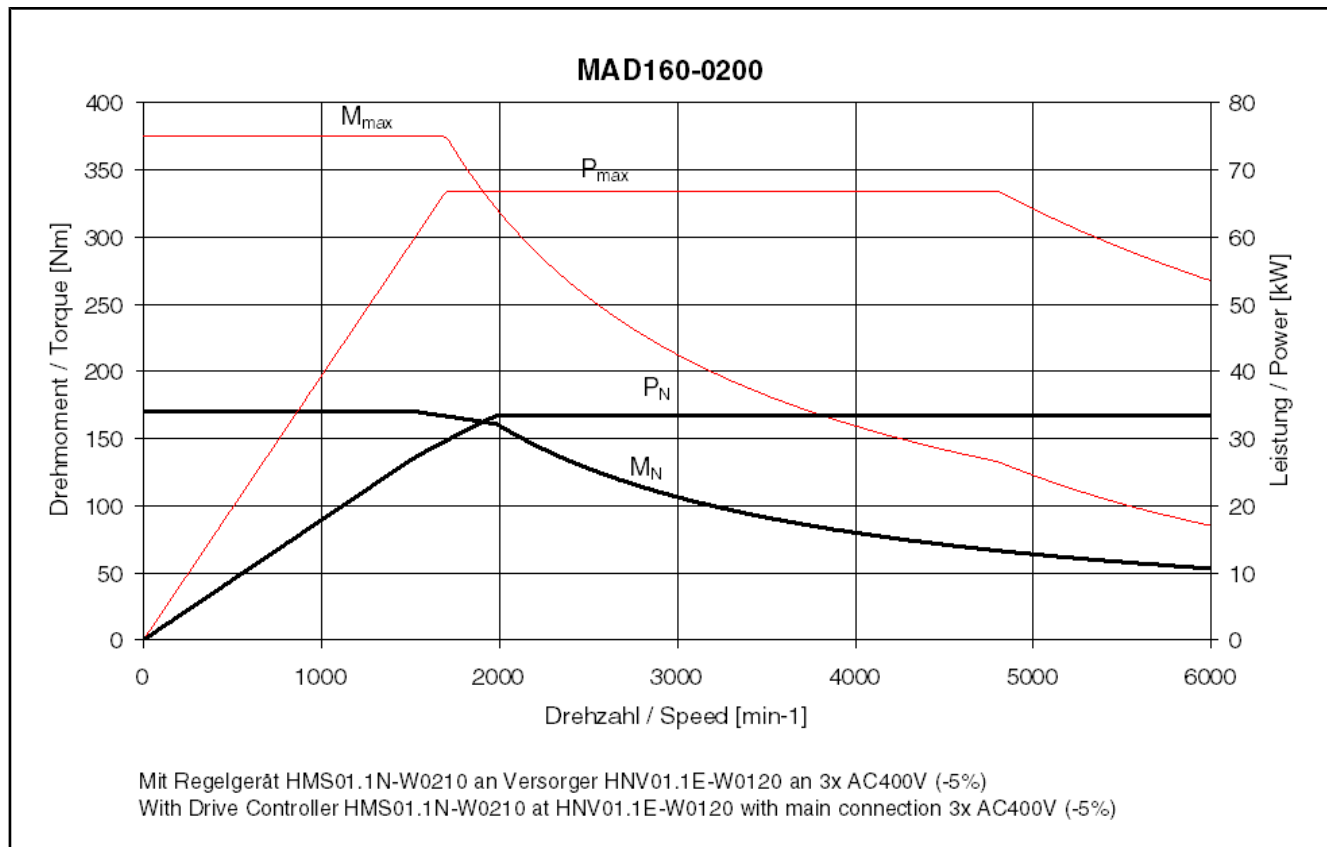

Fig.4-51: Motor characteristic curve of MAD160B-0200

4.5.3 Data Sheet of MAD160C

Parameter	Symbol	Unit	MAD160C			
			0050	0100	0150	0200
Rated torque ¹⁾	M_N	Nm	240.0	225.0	215.0	210.0
Rated power	P_N	kW	12.60	23.56	33.80	44.00
Rated current	I_N	A	27.6	52.9	75.3	93.9
Rated speed	n_N	1/min	500	1,000	1,500	2,000
Key speed	n_1	1/min	500		1,000	1,500
Maximum speed with bearing A	n_{max}	1/min	3,000	6,000		
Maximum speed with bearing H	n_{max}	1/min	3,000	6,000	8,000	
Maximum speed with bearing N	n_{max}	1/min	3,000	6,000		
Maximum speed with bearing V	n_{max}	1/min	3,000	6,000		
Maximum torque	M_{max}	Nm	528.2	530.0	496.0	494.2
Maximum power	P_{S6max}	kW	25.83	51.52	69.29	90.20
Maximum current	$I_{max(eff)}$	A	54.8	112.3	152.6	182.4
Continuous torque at standstill	M_{n1}	Nm	240.0		225.0	
Continuous current at standstill	I_{n1}	A	27.6	55.7	77.8	93.9
Torque constant at 20 °C	$K_{M,N}$	Nm/A	9.95	4.95	3.36	2.63
Thermal time constant	T_{th_nenn}	min	15.0			
Cycle duration (S6 - 44%)	T_C	min	10	1	10	
Discharge capacity of the component	C_{ab}	nF	28.0	25.7	27.2	32.3
Number of pole pairs	p	--	2			
Power wire cross-section	A	mm ²	4.0	10.0	25.0	
Mass	m_{mot}	kg	238.0			
Rotor moment of inertia	J_{rot}	kg * m ²	0.3110000			
Sound pressure level	L_p	dB[A]	75 (+3)			
Ambient air temperature during operation	T_{um}	°C	0...+40			
Insulation class according to DIN EN 60034-1	I.CL.	-	155			

Last revision: 2010-10-28

1) Please note the information on the specified parameters at the beginning of this chapter

Fig.4-52: MAD160C - Technical data

Technical Data

4.5.4 Motor Characteristic Curves of MAD160C

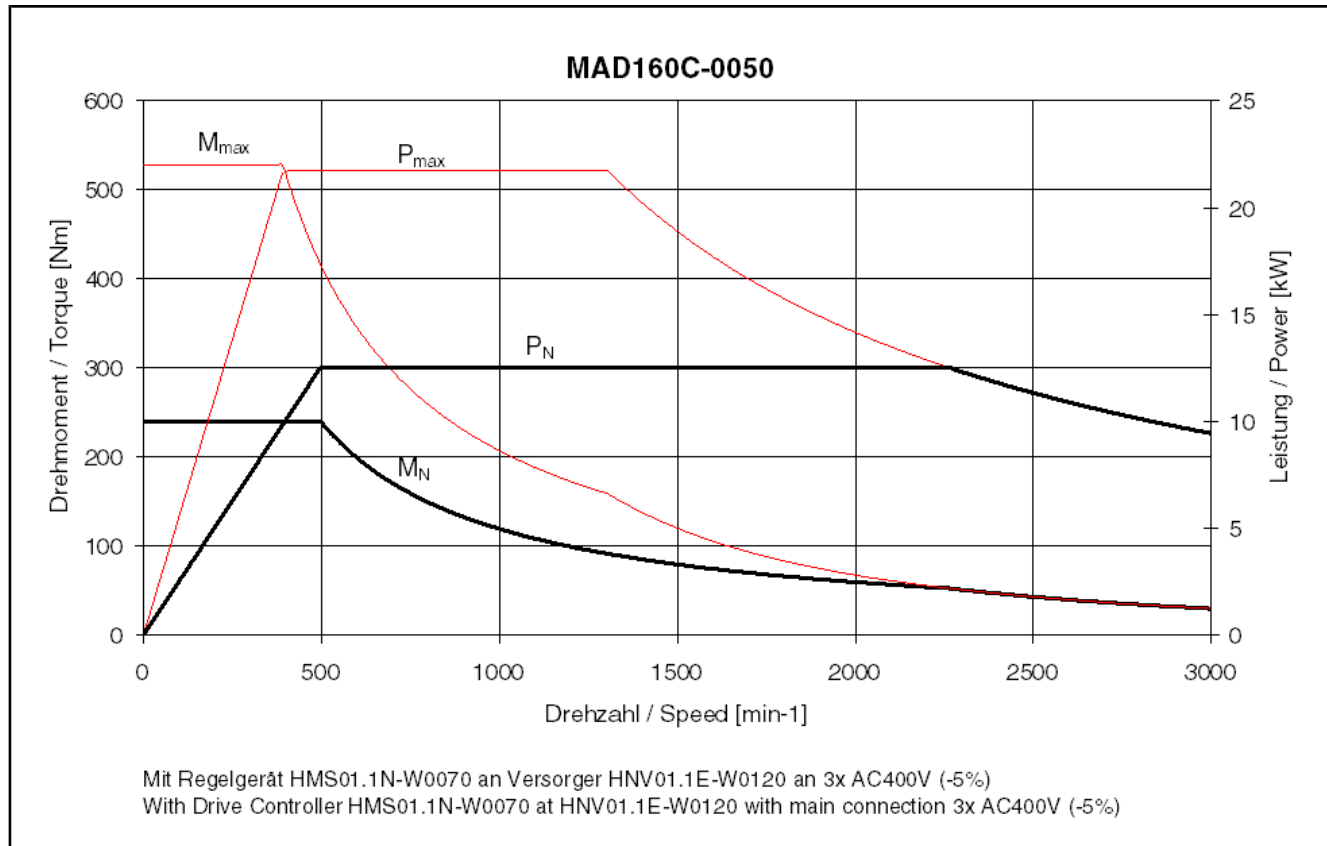

Fig.4-53: Motor characteristic curve of MAD160C-0050

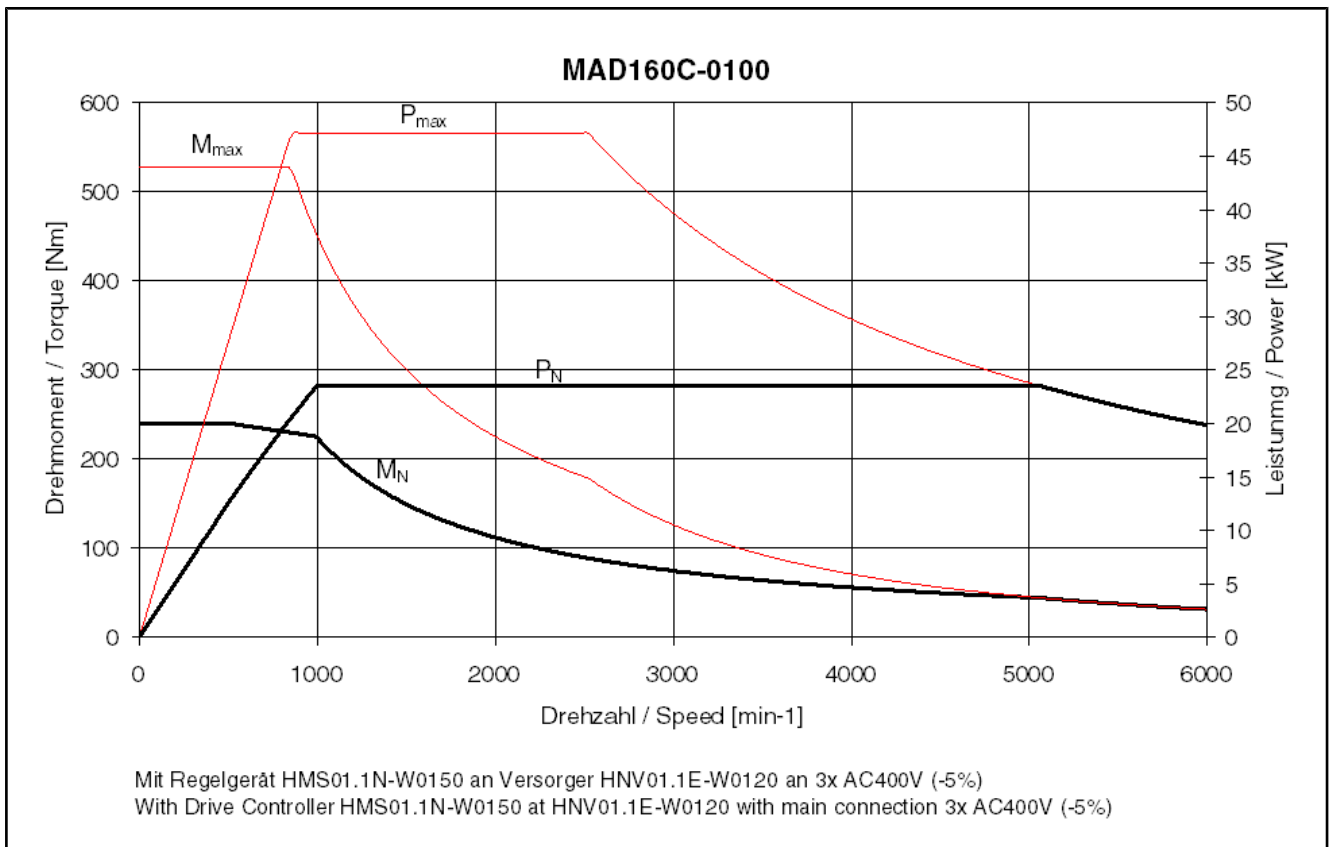

Fig.4-54: Motor characteristic curve of MAD160C-0100

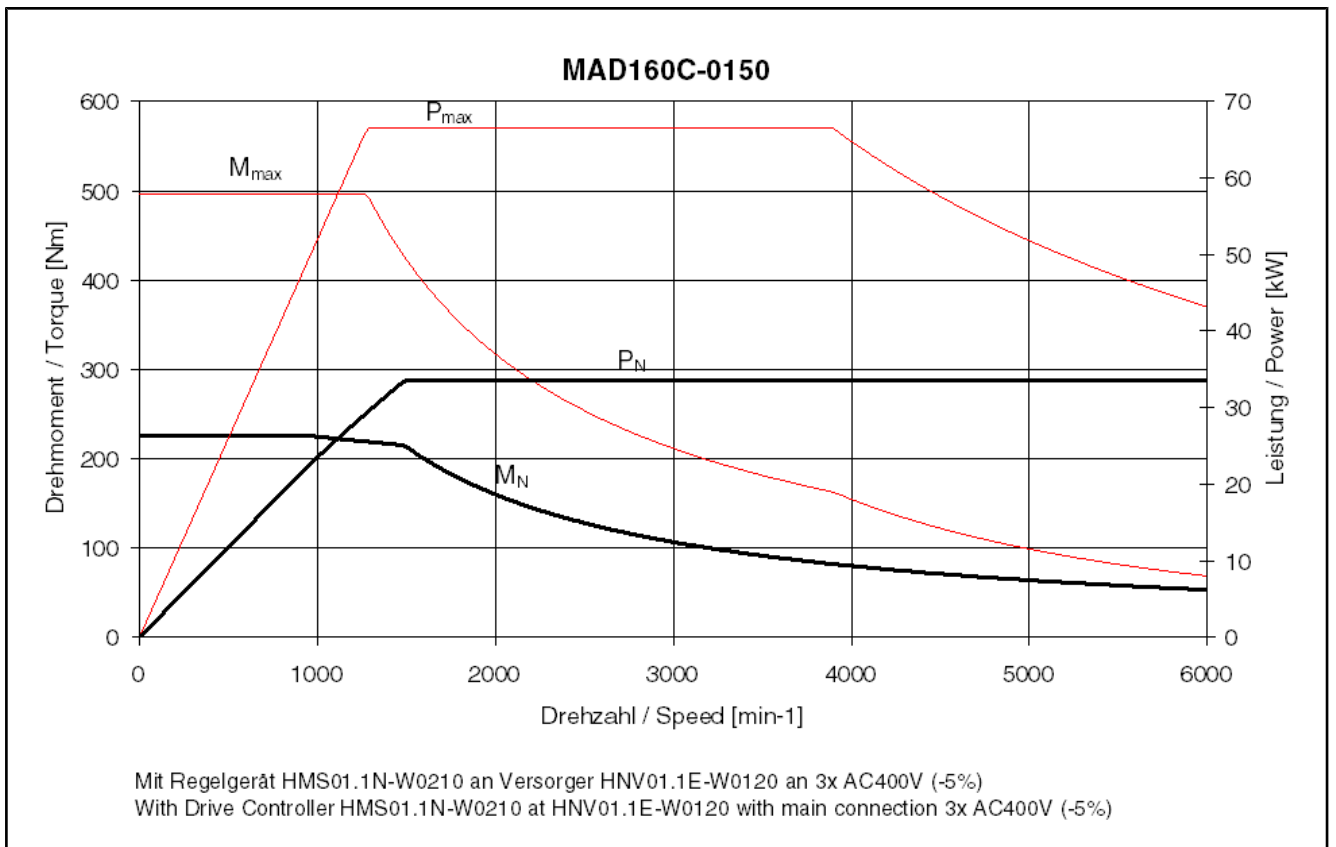

Fig.4-55: Motor characteristic curve of MAD160C-0150

Technical Data

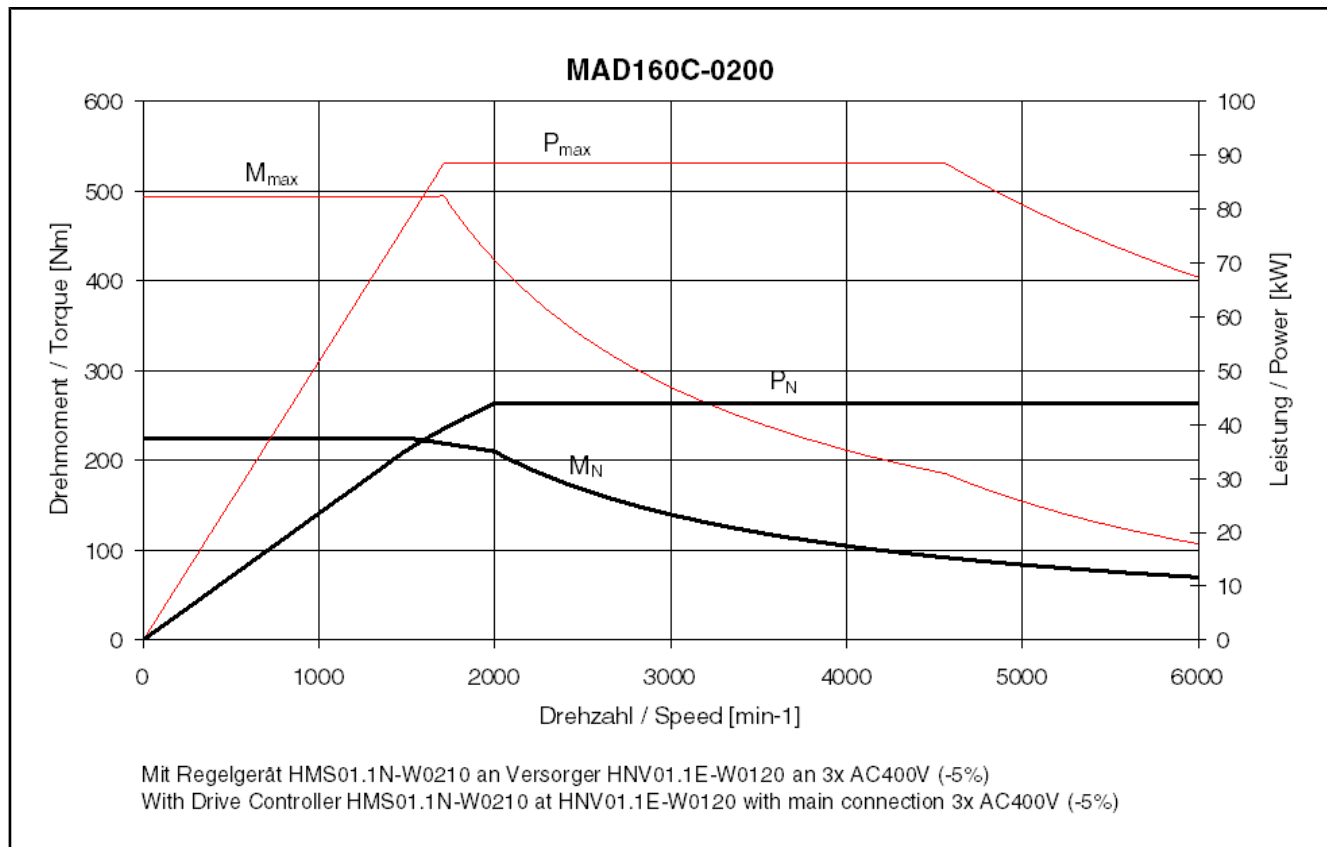

Fig.4-56: Motor characteristic curve of MAD160C-0200

4.5.5 Motor Fan MAD160

Motor fan MAD160 - electrical data

Designation	Symbol	Unit	Value	
Voltage type		-	3~ AC	
Air flow direction		-	B ⇒ A	
Mean volume flow		m ³ /h	520.0	
Nominal voltage	U _N	V	400	480
Nominal frequency	f	Hz	50 / 60	
Fan current ¹⁾	I _N	A	0.21 / 0.28	0.24 / 0.26
Blocking current	I _{block}	A	0.54 / 0.63	0.68 / 0.73
Power consumption	S _N	VA	145.50 / 193.98	199.53 / 216.16

Last revision: 2010-02-02

1) Fan current monitoring should start at I_N + 20%.

Fig.4-57: Data sheet of motor fan MAD160

4.5.6 Holding Brake MAD/MAF160 (Optional)

Data sheet - holding brake MAD/MAF160

Designation	Symbol	Unit	BRAKE 5 Electrically clamping	BRAKE 3 (MAD only) Electrically releasing, reinforced design	BRAKE 1 Electrically releasing
Holding torque	M ₄	Nm	100.0	240.0	100.0
Rated voltage	U _N	V	24		
Rated current	I _N	A	1.80	1.87	2.00
Holding brake moment of inertia	J _{br}	kg*m ²	0.005010	0.018800	0.005300
Connection time	t ₁	ms	85	130	70
Disconnection time	t ₂	ms	100	300	190
Maximum holding brake speed	n _{Br_max}	min ⁻¹	8,000	6,000	8,000

Last revision: 2006-10-23

Fig.4-58: Technical data of holding brake MAD/MAF160 (optional)

Technical Data

4.6 Technical Data of MAD180

4.6.1 Data Sheet of MAD180C

Parameter	Symbol	Unit	MAD180C			
			0050	0100	0150	0200
Rated torque ¹⁾	M_N	Nm	325.0	300.0	270.0	250.0
Rated power	P_N	kW	17.00	31.40	42.40	52.40
Rated current	I_N	A	38.2	69.0	88.6	104.6
Rated speed	n_N	1/min	500	1,000	1,500	2,000
Key speed	n_1	1/min	500		1,000	1,500
Maximum speed with bearing A	n_{max}	1/min	3,000	6,000		
Maximum speed with bearing N	n_{max}	1/min	3,000	6,000		
Maximum speed with bearing V	n_{max}	1/min	3,000	5,000		
Maximum torque	M_{max}	Nm	715.5	620.0	681.0	594.4
Maximum power	P_{S6max}	kW	34.85	64.37	86.92	107.42
Maximum current	$I_{max(eff)}$	A	76.6	147.6	182.1	221.7
Continuous torque at standstill	M_{n1}	Nm	325.0	330.0	300.0	270.0
Continuous current at standstill	I_{n1}	A	38.2	75.0	91.0	110.0
Torque constant at 20 °C	$K_{M,N}$	Nm/A	10.00	5.19	3.47	2.71
Thermal time constant	T_{th_nenn}	min	45.0			
Cycle duration (S6 - 44%)	T_C	min	10			
Discharge capacity of the component	C_{ab}	nF	29.2	25.2	28.3	31.6
Number of pole pairs	p	--	2			
Power wire cross-section	A	mm ²	6.0	16.0	25.0	35.0
Mass	m_{mot}	kg	334.0			
Rotor moment of inertia	J_{rot}	kg * m ²	0.4580000			
Sound pressure level	L_P	dB[A]	78 (+3)			
Ambient air temperature during operation	T_{um}	°C	0...+40			
Insulation class according to DIN EN 60034-1	I.CL.	-	155			

Last revision: 2008-08-06

1) Please note the information on the specified parameters at the beginning of this chapter

Fig. 4-59: MAD180C - Technical data

4.6.2 Motor Characteristic Curves of MAD180C

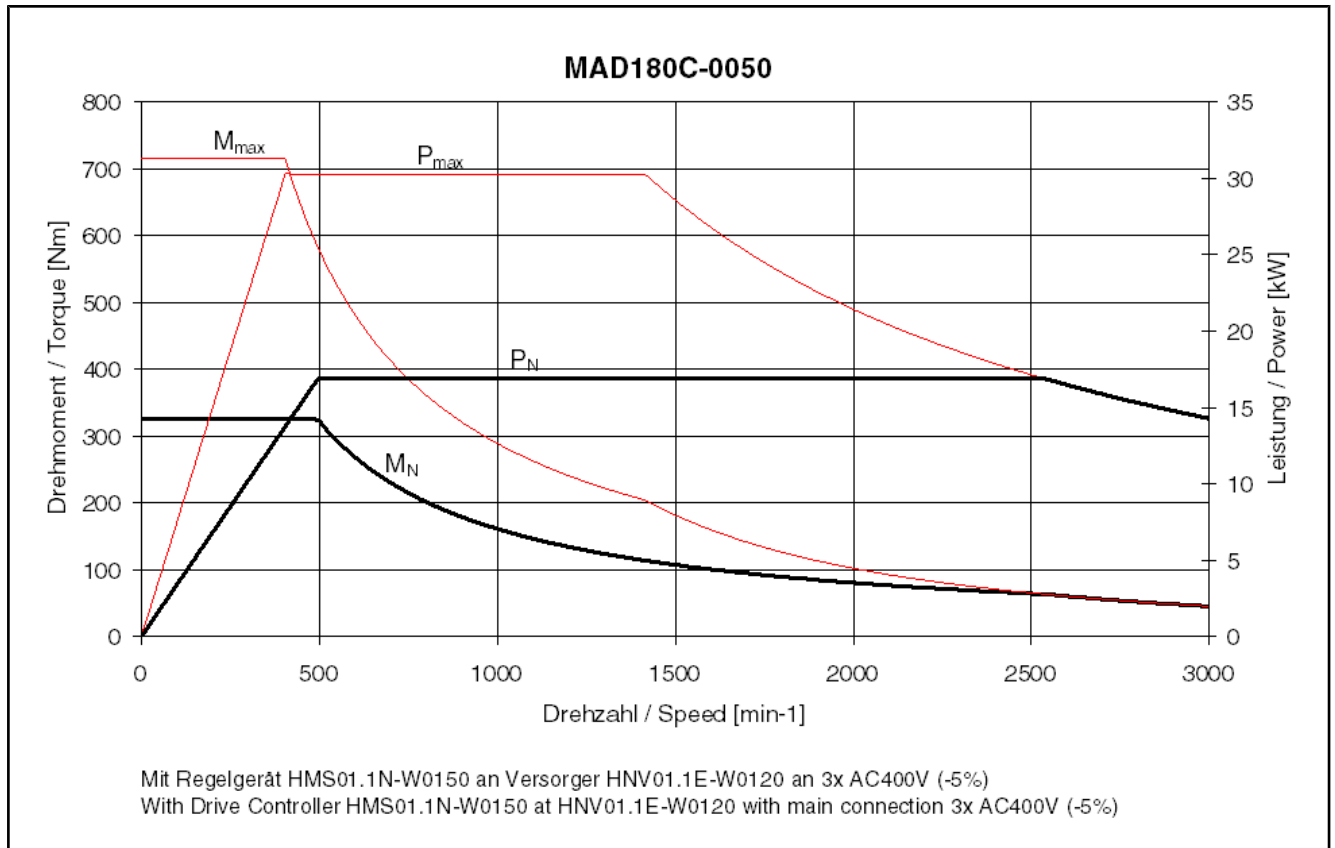

Fig.4-60: Motor characteristic curve of MAD180C-0050

Technical Data

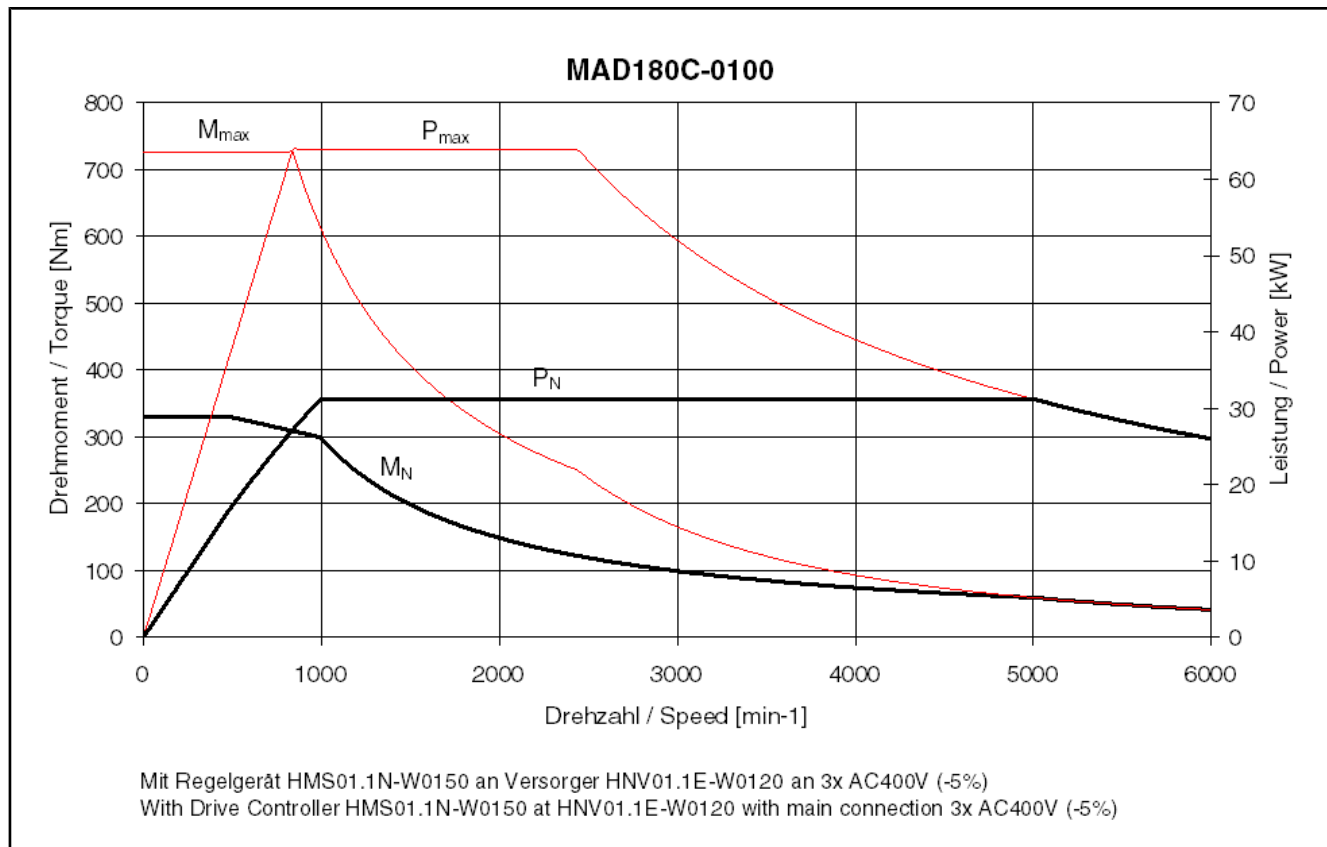

Fig.4-61: Motor characteristic curve of MAD180C-0100

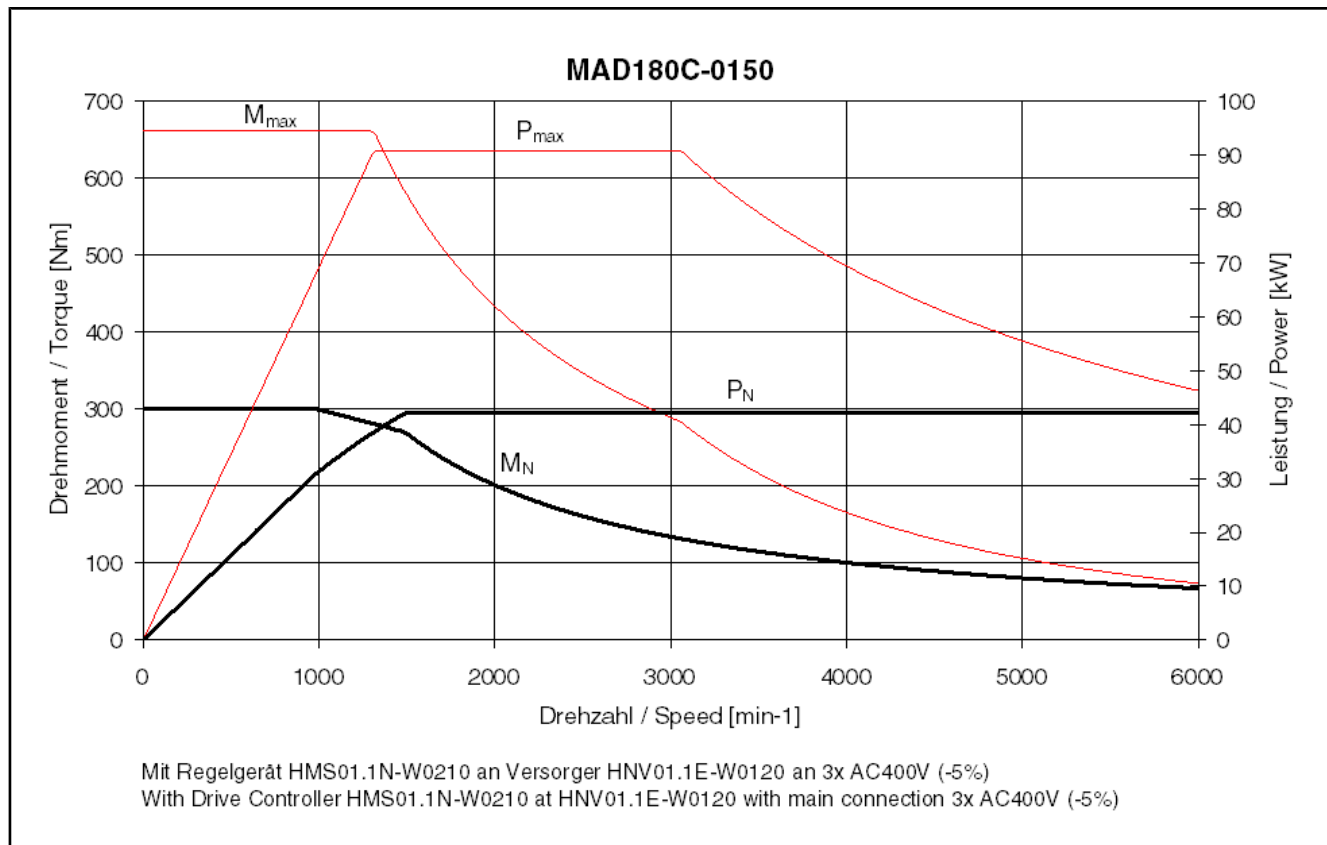

Fig.4-62: Motor characteristic curve of MAD180C-0150

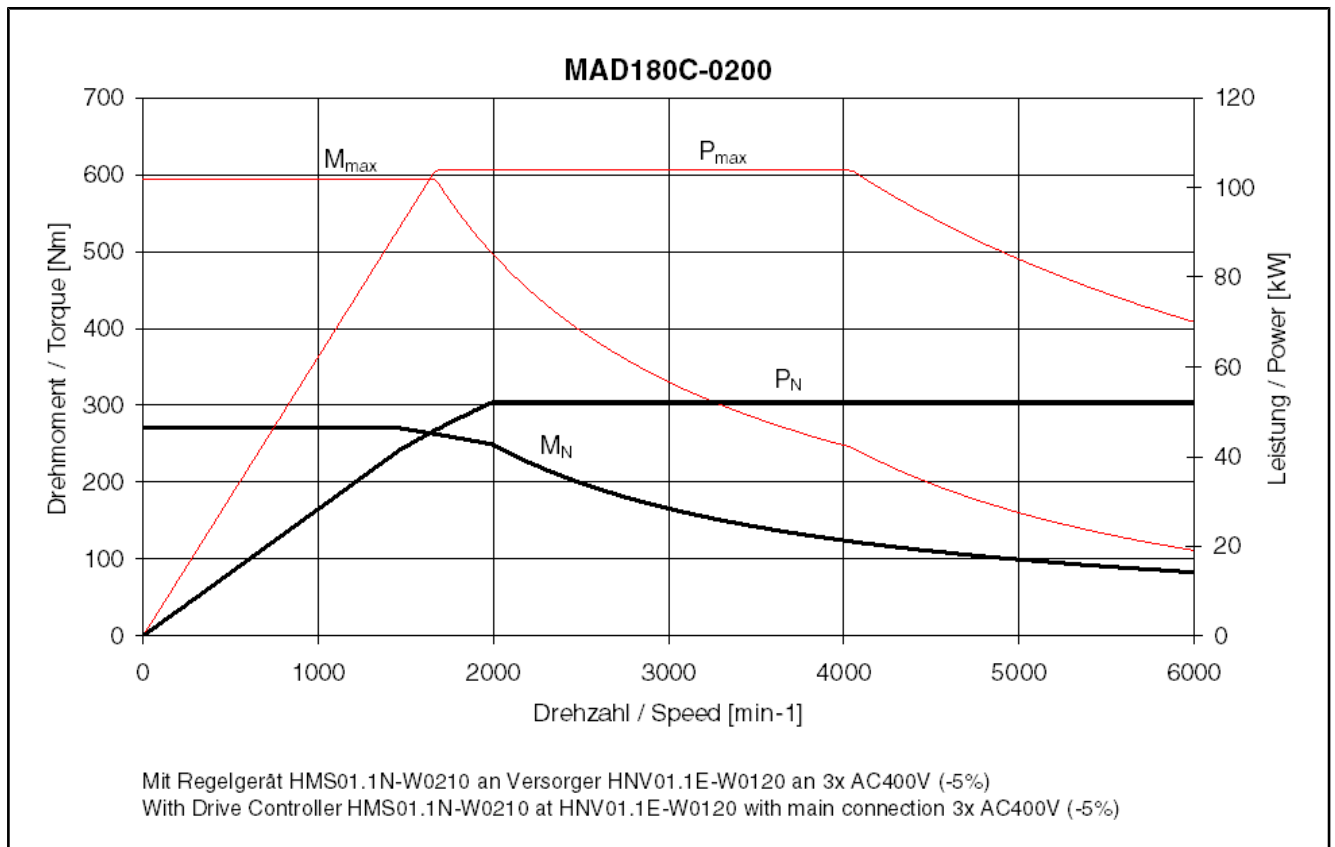

Fig.4-63: Motor characteristic curve of MAD180C-0200

Technical Data

4.6.3 Data Sheet of MAD180D

Parameter	Symbol	Unit	MAD180D			
			0050	0100	0150	0200
Rated torque ¹⁾	M_N	Nm	390.0	370.0	340.0	300.0
Rated power	P_N	kW	20.40	38.70	53.40	62.80
Rated current	I_N	A	39.7	82.4	107.4	117.4
Rated speed	n_N	1/min	500	1,000	1,500	2,000
Key speed	n_1	1/min	500		1,000	1,500
Maximum speed with bearing A	n_{max}	1/min	3,000	6,000		
Maximum speed with bearing N	n_{max}	1/min	3,000	6,000		
Maximum speed with bearing V	n_{max}	1/min	3,000	5,000		
Maximum torque	M_{max}	Nm	857.8	901.5	794.0	768.2
Maximum power	P_{S6max}	kW	41.82	79.34	109.48	128.74
Maximum current	$I_{max(eff)}$	A	78.4	188.0	220.8	269.7
Continuous torque at standstill	M_{n1}	Nm	390.0	410.0	370.0	330.0
Continuous current at standstill	I_{n1}	A	39.7	90.0	112.3	132.6
Torque constant at 20 °C	$K_{M,N}$	Nm/A	11.31	5.66	3.72	2.92
Thermal time constant	T_{th_nenn}	min	45.0			
Cycle duration (S6 - 44%)	T_C	min	10			
Discharge capacity of the component	C_{ab}	nF	38.0	38.4	35.9	38.0
Number of pole pairs	p	--	2			
Power wire cross-section	A	mm ²	10.0	25.0	35.0	2 x 25.0
Mass	m_{mot}	kg	403.0			
Rotor moment of inertia	J_{rot}	kg * m ²	0.5940000			
Sound pressure level	L_P	dB[A]	78 (+3)			
Ambient air temperature during operation	T_{um}	°C	0...+40			
Insulation class according to DIN EN 60034-1	I.CL.	-	155			

Last revision: 2010-03-11

1) Please note the information on the specified parameters at the beginning of this chapter
 Fig.4-64: MAD180D - Technical data

4.6.4 Motor Characteristic Curves of MAD180D

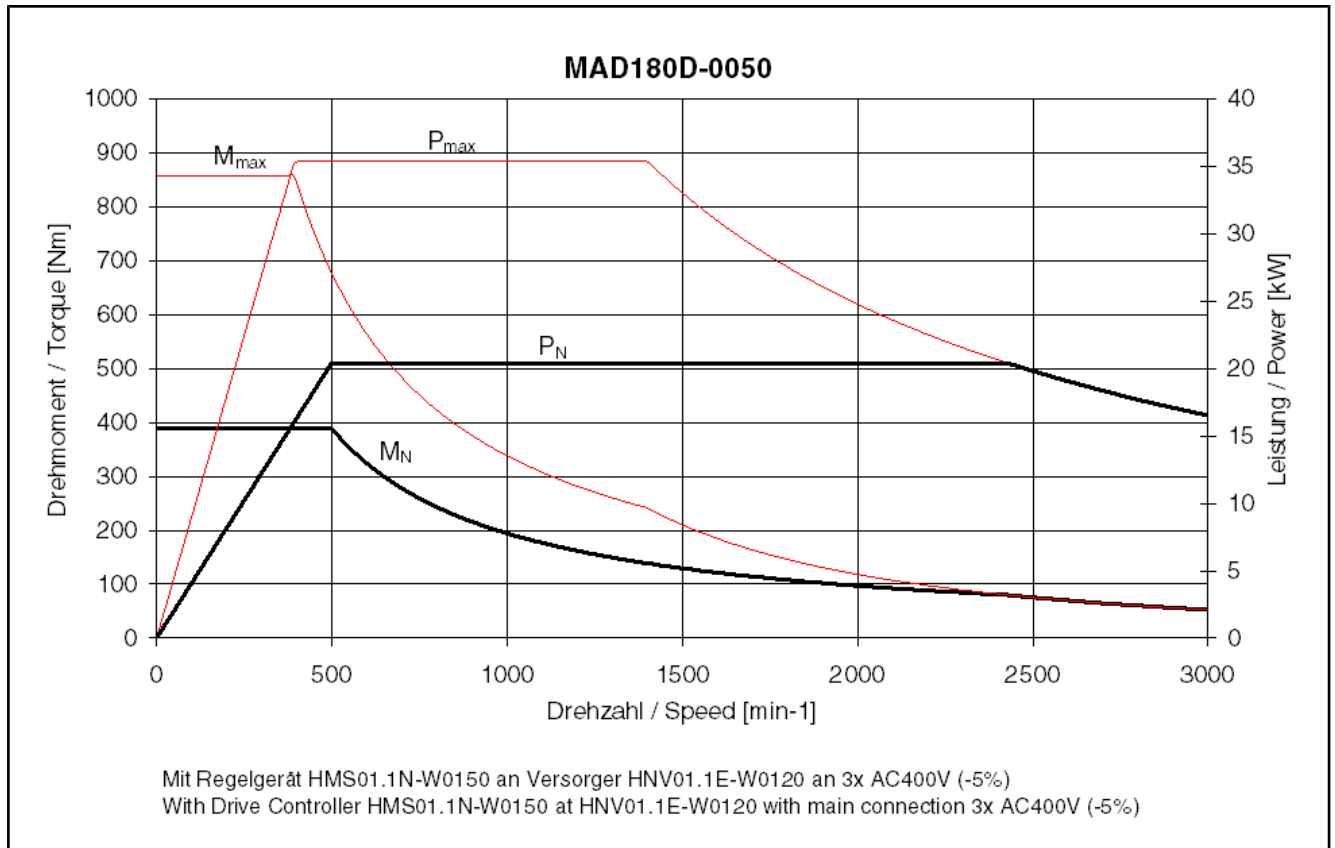

Fig.4-65: Motor characteristic curve of MAD180D-0050

Technical Data

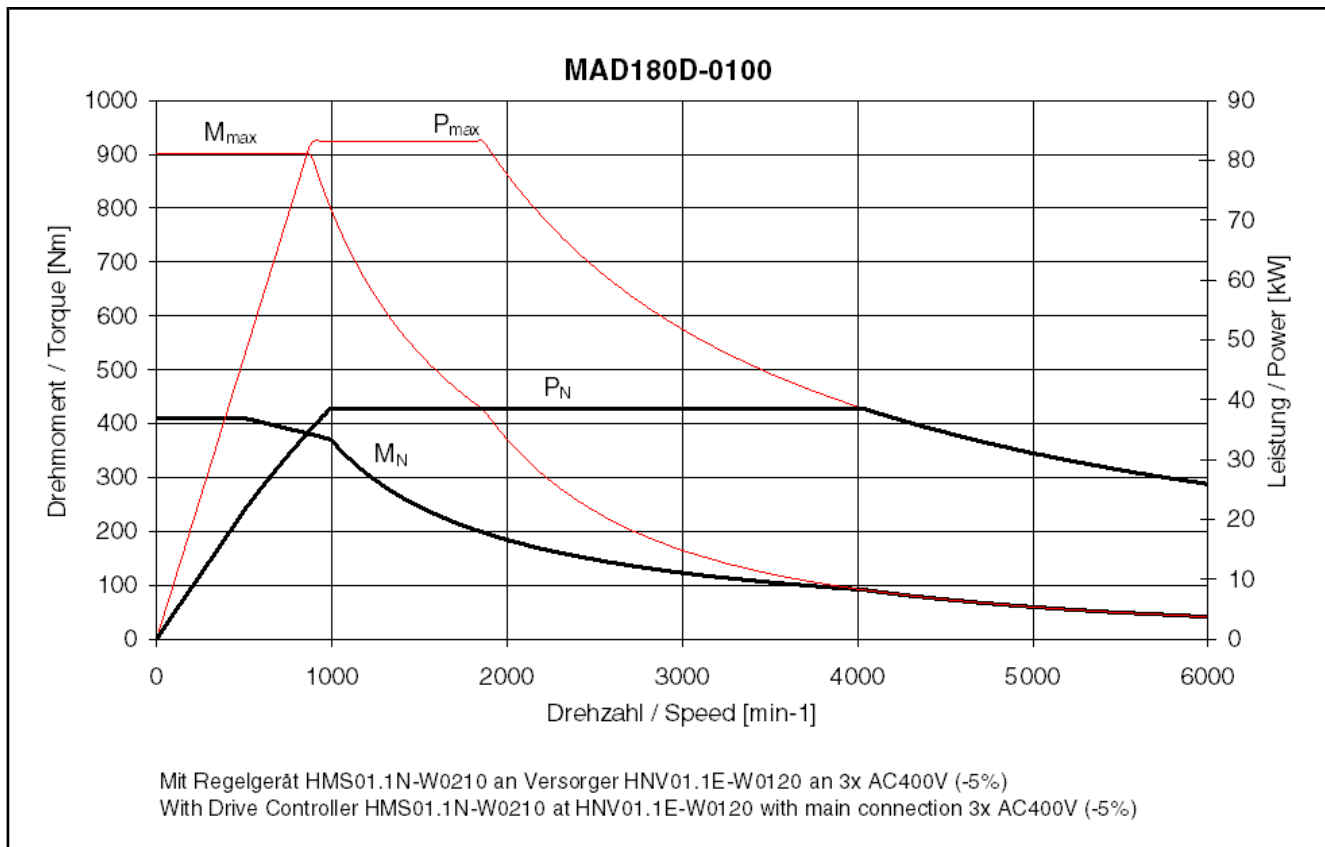

Fig.4-66: Motor characteristic curve of MAD180D-0100

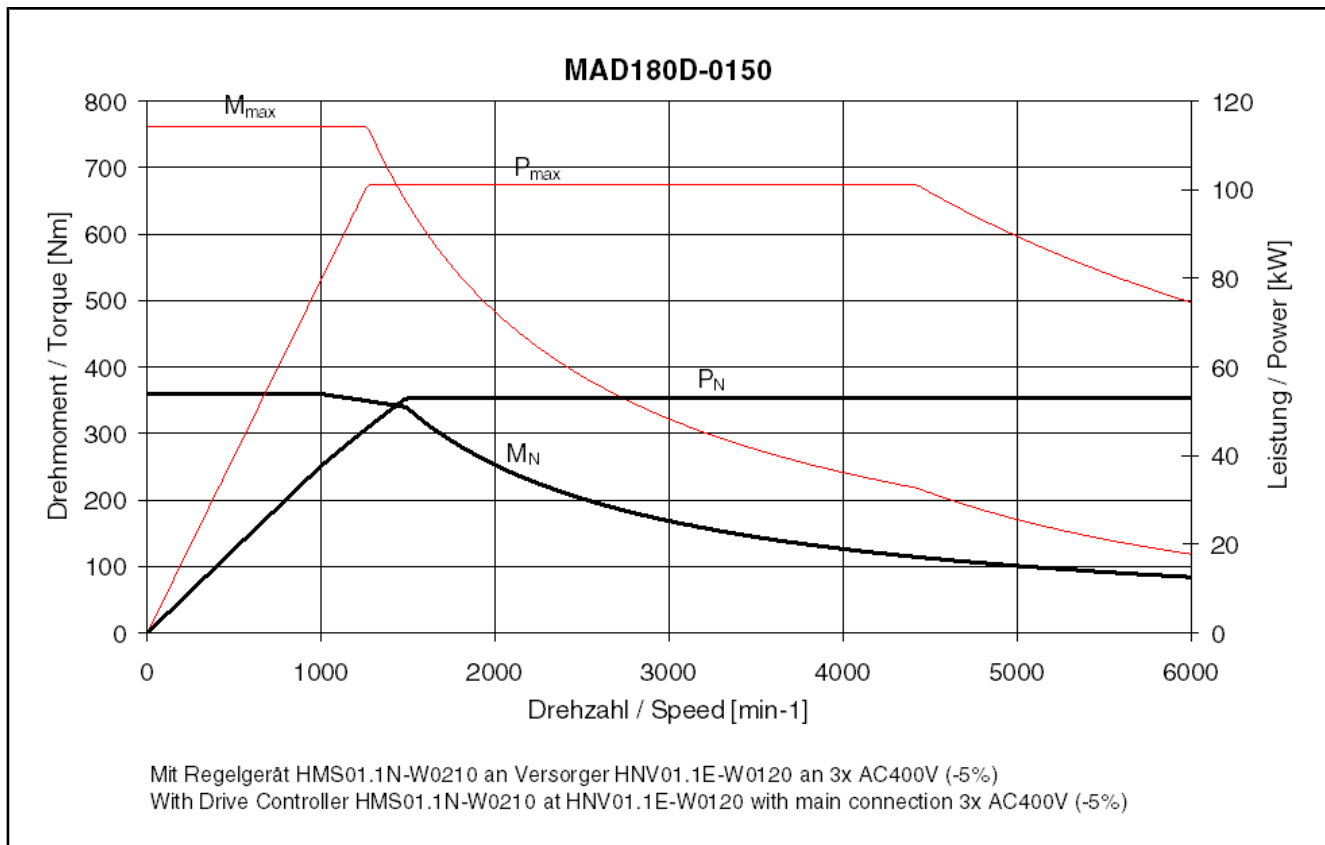

Fig.4-67: Motor characteristic curve of MAD180D-0150

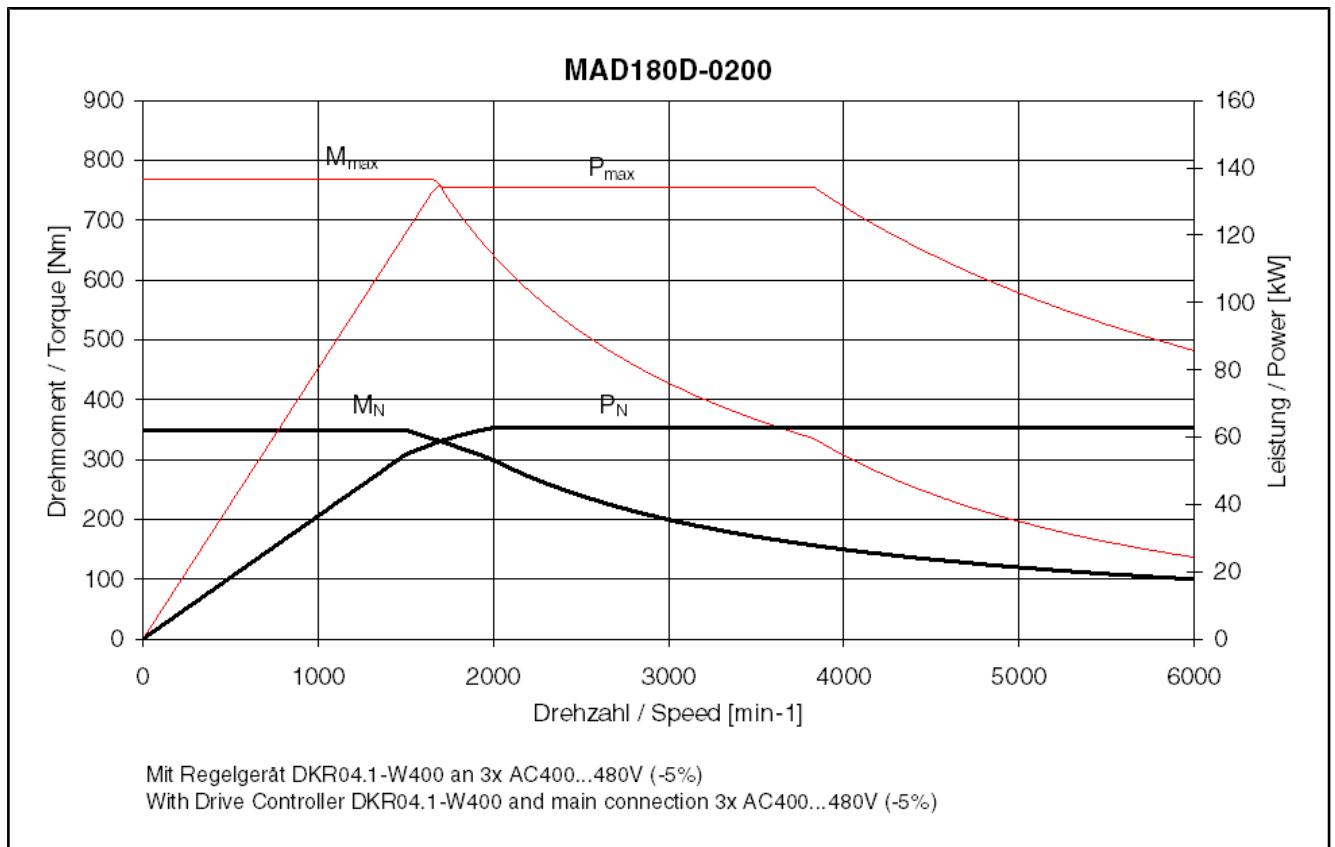

Fig.4-68: Motor characteristic curve of MAD180D-0200

Technical Data

4.6.5 Motor Fan MAD180**Motor fan MAD180 - electrical data**

Designation	Symbol	Unit	Value	
Voltage type		-	3~ AC	
Air flow direction		-	B ⇒ A	
Mean volume flow		m ³ /h	700.0	
Nominal voltage	U_N	V	400	480
Nominal frequency	f	Hz	50 / 60	
Fan current ¹⁾	I_N	A	0.39 / 0.56	0.41 / 0.50
Blocking current	I_{block}	A	1.10 / 1.11	1.31 / 1.29
Power consumption	S_N	VA	270.20 / 193.99	199.53 / 415.69
Last revision: 2010-02-02				

1) Fan current monitoring should start at $I_N + 20\%$.

Fig.4-69: Data sheet of motor fan MAD180

4.6.6 Holding Brake MAD/MAF180 (Optional)**Data sheet - holding brake MAD/MAF180**

Designation	Symbol	Unit	BRAKE 5 Electrically clamping	BRAKE 2 Electrically releasing
Holding torque	M_4	Nm	300.0	240.0
Rated voltage	U_N	V	24	
Rated current	I_N	A	2.00	1.87
Holding brake moment of inertia	J_{br}	kg*m ²	0.018800	
Connection time	t_1	ms	150	130
Disconnection time	t_2	ms	90	300
Maximum holding brake speed	n_{Br_max}	min ⁻¹	6,000	
Last revision: 2006-10-20				

Fig.4-70: Technical data of holding brake MAD/MAF180 (optional)

4.7 Technical Data of MAD225

4.7.1 Data Sheet of MAD225C

Parameter	Symbol	Unit	MAD225C		
			0050*	0100	0150
Rated torque ¹⁾	M_N	Nm	660.0	640.0	593.0
Rated power	P_N	kW	34.56	67.02	93.10
Rated current	I_N	A	72.0	121.0	174.0
Rated speed	n_N	1/min	500	1,000	1,500
Key speed	n_1	1/min	500		1,000
Maximum speed with bearing N	n_{max}	1/min	3,000	3,750	
Maximum speed with bearing V	n_{max}	1/min	3,000	3,750	
Maximum torque	M_{max}	Nm	1,450.0		
Maximum power	P_{S6max}	kW	70.84	137.39	190.70
Maximum current	$I_{max(eff)}$	A	151.9	265.9	376.3
Continuous torque at standstill	M_{n1}	Nm	660.0	680.0	660.0
Continuous current at standstill	I_{n1}	A	72.0	126.3	187.0
Torque constant at 20 °C	$K_{M,N}$	Nm/A	10.22	5.98	3.90
Thermal time constant	T_{th_nenn}	min	45.0		
Cycle duration (S6 - 44%)	T_C	min	5		
Discharge capacity of the component	C_{ab}	nF	120.0	48.5	126.0
Number of pole pairs	p	--	2		
Power wire cross-section	A	mm ²	25.0	2 x 25.0	2 x 35.0
Mass	m_{mot}	kg	610.0		
Rotor moment of inertia	J_{rot}	kg * m ²	1.6500000		
Sound pressure level	L_P	dB[A]	78 (+3)		
Ambient air temperature during operation	T_{um}	°C	0...+40		
Insulation class according to DIN EN 60034-1	---	-	155		

Last revision: 2009-01-15

1) Please note the information on the specified parameters at the beginning of this chapter

* Provisional values
 Fig.4-71: MAD225C - Technical data

Technical Data

4.7.2 Motor Characteristic Curves of MAD225C

Motor characteristic curve of MAD225C-0050 (in preparation)



Fig.4-72: Motor characteristic curve MAD225C-0100

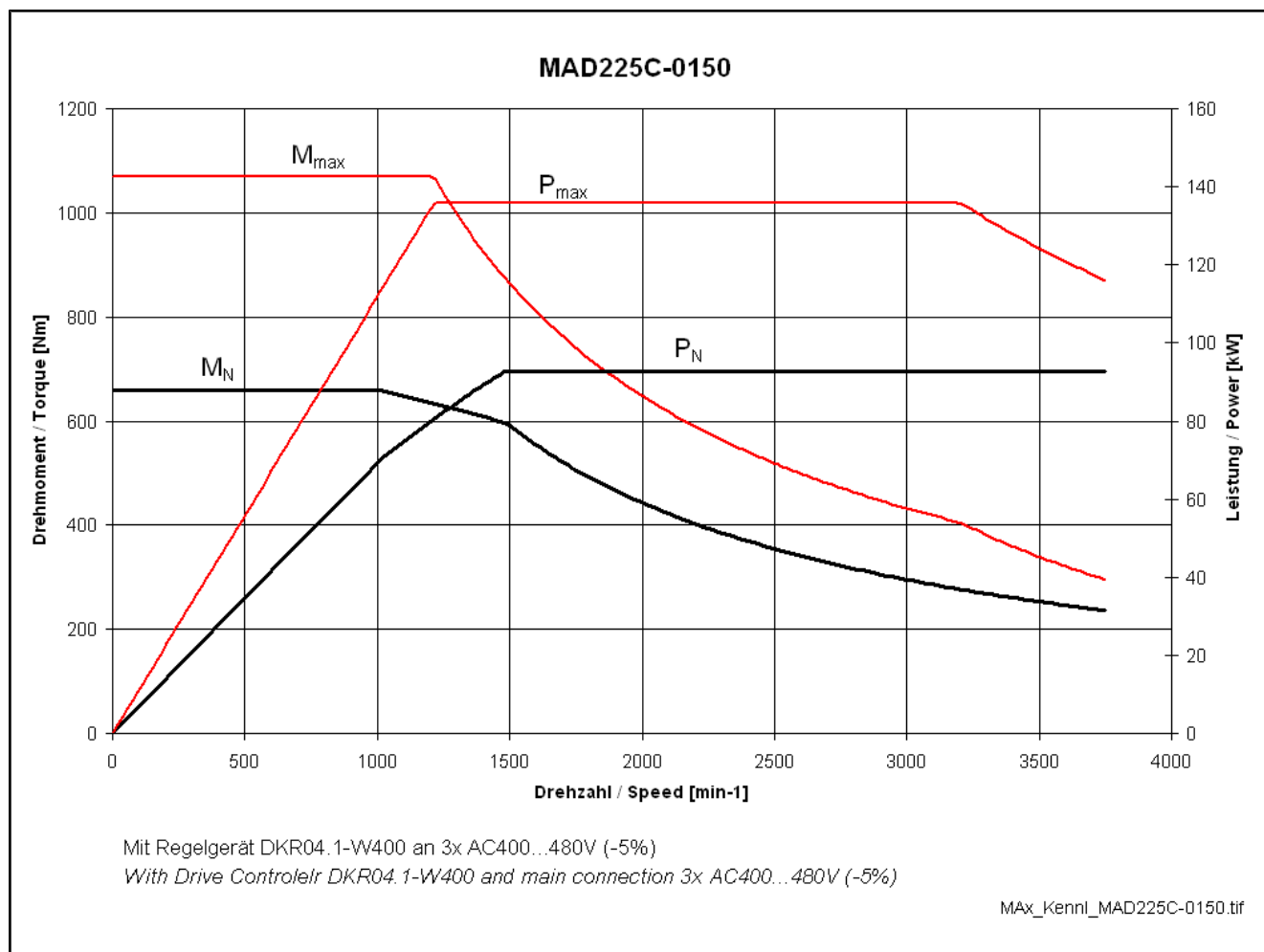

Fig.4-73: Motor characteristic curve MAD225C-0150

4.7.3 Motor Fan MAD225

Motor fan MAD225 - electrical data

Designation	Symbol	Unit	Value	
Voltage type		-	3~ AC	
Air flow direction		-	B ⇒ A	
Mean volume flow		m ³ /h	700.0	
Nominal voltage	U_N	V	400	480
Nominal frequency	f	Hz	50 / 60	
Fan current ¹⁾	I_N	A	0.35 / 0.49	0.38 / 0.45
Blocking current	I_{block}	A	1.13 / 1.02	1.38 / 1.25
Power consumption	S_N	VA	242.49 / 339.48	315.93 / 374.12

Last revision: 2010-02-02

1) Fan current monitoring should start at $I_N + 20\%$.

Fig.4-74: Data sheet of motor fan MAD225

Technical Data

4.8 Technical Data of MAF100

4.8.1 Data Sheet of MAF100B

Parameter	Symbol	Unit	MAF100B				
			0050	0100	0150	0200	0250
Rated torque ¹⁾	M_N	Nm	50.0	46.0	42.0	38.0	33.0
Rated power	P_N	kW	2.60	4.82	6.60	8.00	8.64
Rated current	I_N	A	8.5	15.2	18.1	23.9	26.0
Rated speed	n_N	1/min	500	1,000	1,500	2,000	2,500
Key speed	n_1	1/min	500		1,000	1,500	2,000
Maximum torque	M_{max}	Nm	109.7	110.0	101.4	92.4	83.6
Maximum power	P_{S6max}	kW	5.33	9.88	13.53	16.40	17.71
Maximum current	$I_{max(eff)}$	A	20.3	33.3	46.2	51.7	50.7
Maximum speed with bearing A	n_{max}	1/min	3,000	6,000	9,000		
Maximum speed with bearing H	n_{max}	1/min	3,000	6,000	9,000	11,000	
Maximum speed with bearing N	n_{max}	1/min	3,000	6,000	9,000		
Continuous torque at standstill	M_{n1}	Nm	49.9	47.0	46.1	42.0	38.0
Continuous current at standstill	I_{n1}	A	9.9	15.4	22.7	25.8	26.0
Torque constant at 20 °C	$K_{M,N}$	Nm/A	6.68	3.42	2.76	1.84	1.49
Thermal time constant	T_{th}	min	3.5				
Cycle duration (S6 - 44%)	T_C	min	2				
Discharge capacity of the component	C_{ab}	nF	6.0	6.6	6.0		
Number of pole pairs	p	--	3				
Power wire cross-section	A	mm ²	1.5		2.5	4.0	
Mass	m_{mot}	kg	38.0				
Rotor moment of inertia	J_{rot}	kg * m ²	0.0190000				
Sound pressure level	L_P	dB[A]	70 (+3)				
Ambient air temperature during operation	T_{um}	°C	0...+40				
Insulation class according to DIN EN 60034-1	I.CL.	-	155				
Data on liquid cooling							
Power loss to be dissipated	P_V	kW	1.00	1.15	1.18	1.20	1.25
Coolant supply temperature	T_{ein}	°C	10 ... 40				

Last revision: 2010-11-05

Technical Data

Parameter	Symbol	Unit	MAF100B				
			0050	0100	0150	0200	0250
Allowed coolant temperature rise at P_V	ΔT_{max}	K	10				
Pressure drop at Q_{min}	Δp	bar	0.2		0.3		
Constant for determining the pressure drop with water as cooling medium	$K_{\Delta p}$	-	0.10				
Coolant flow required at P_V	Q_{min}	l/min	1.4	1.6	1.7		1.8
Coolant duct volume	V_{kuehl}	l	0.06				
Maximum allowed input pressure	p_{max}	bar	6.0				

Last revision: 2010-11-05

1) Please note the information on the specified parameters at the beginning of this chapter

Fig.4-75: MAF100B - Technical data

4.8.2 Motor Characteristic Curves of MAF100B

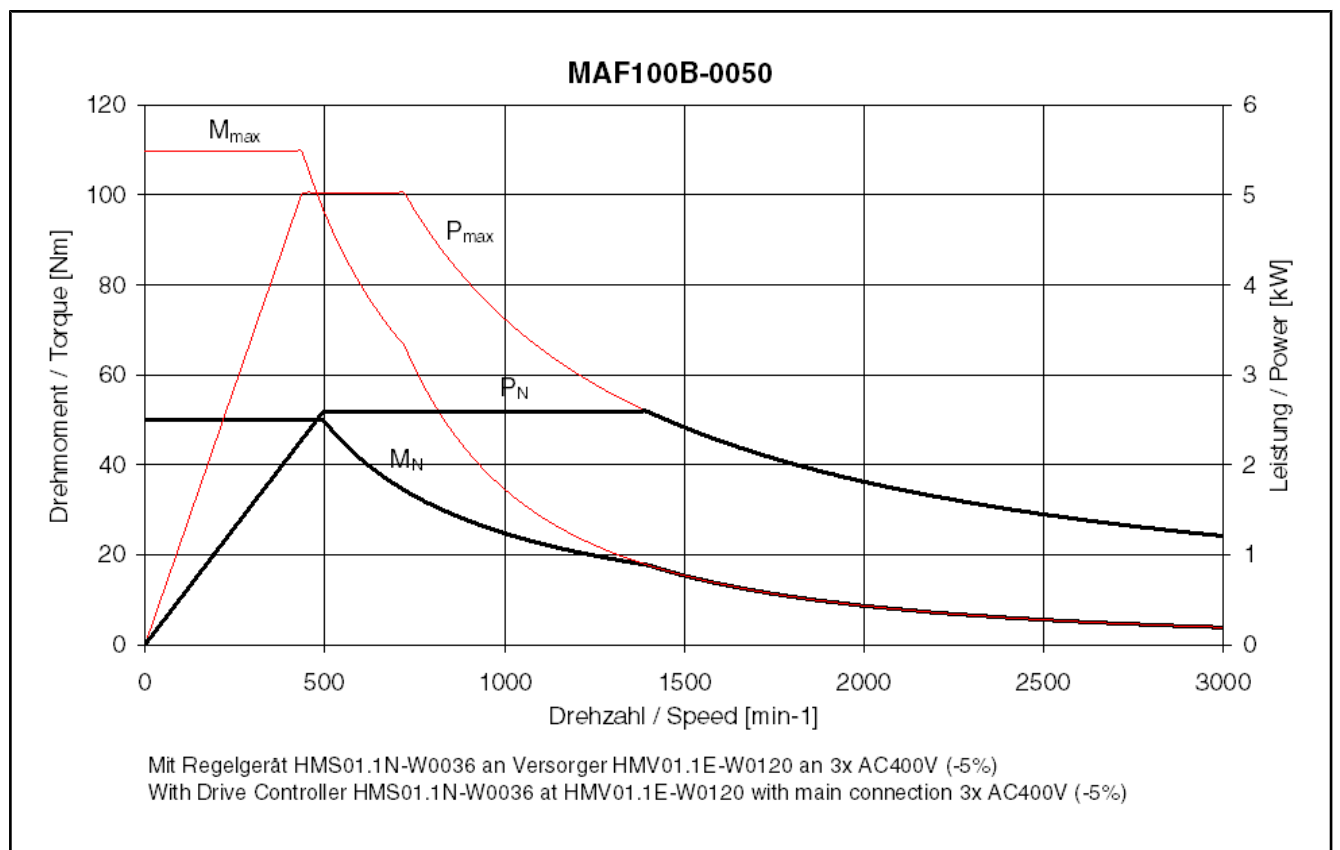

Fig.4-76: Motor characteristic curve of MAF100B-0050

Technical Data

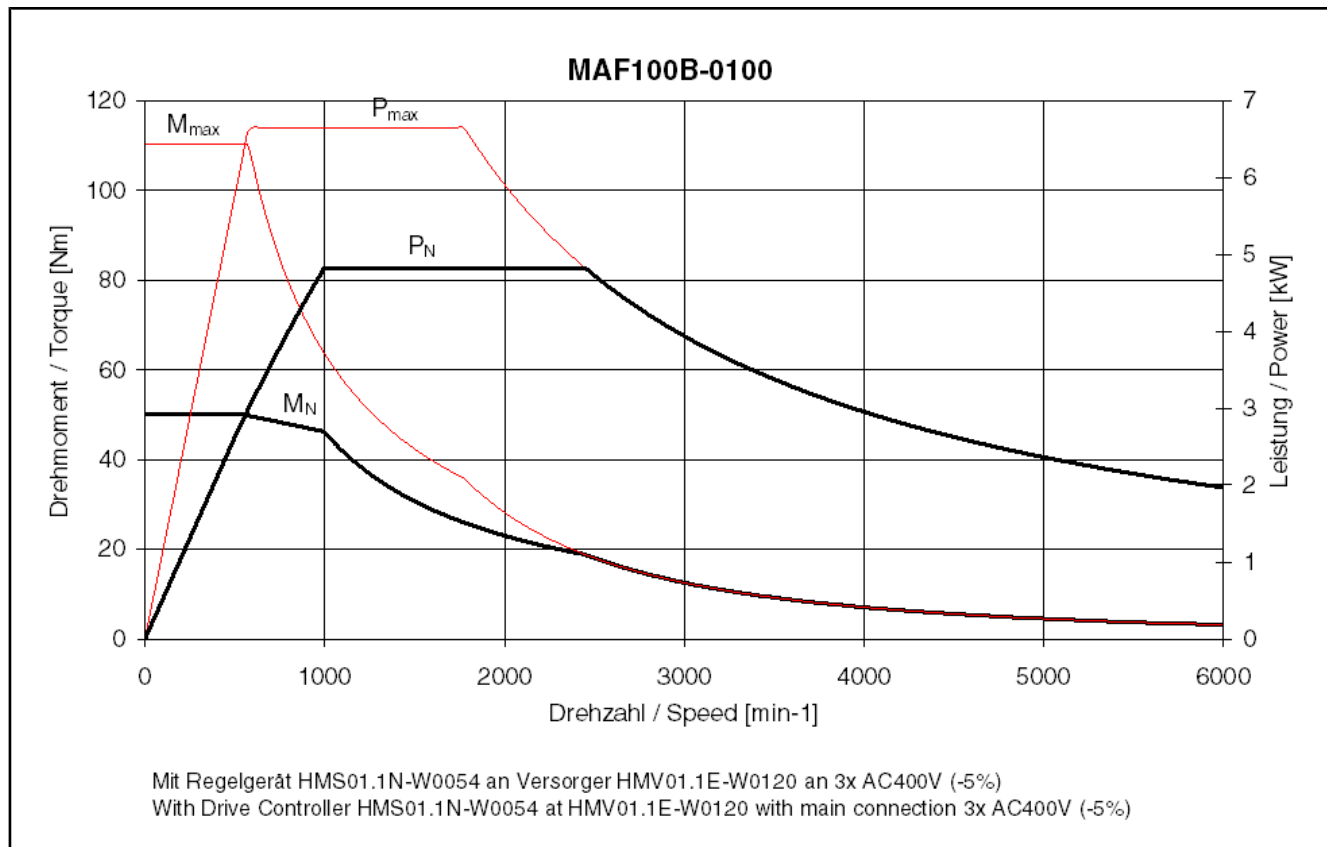

Fig.4-77: Motor characteristic curve of MAF100B-0100

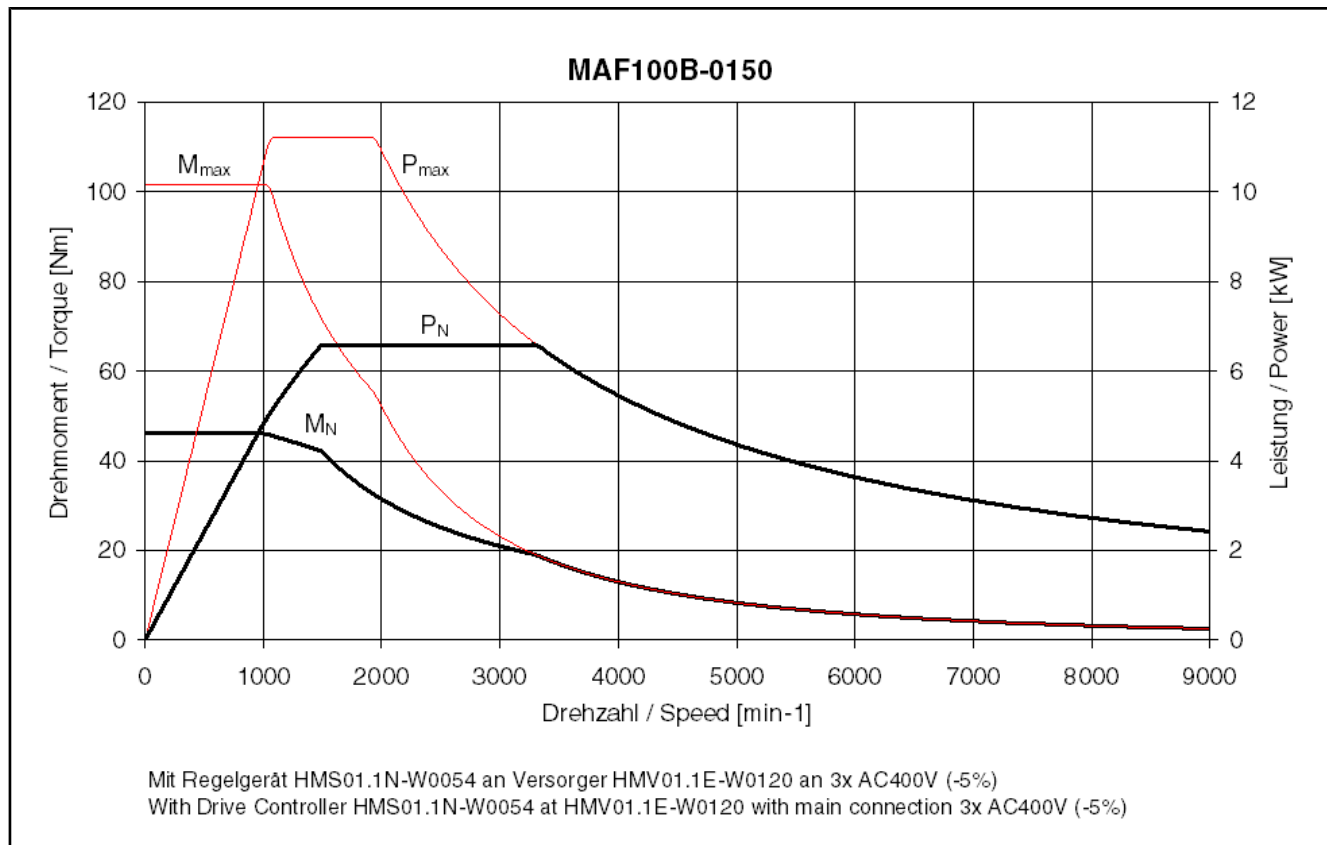

Fig.4-78: Motor characteristic curve of MAF100B-0150

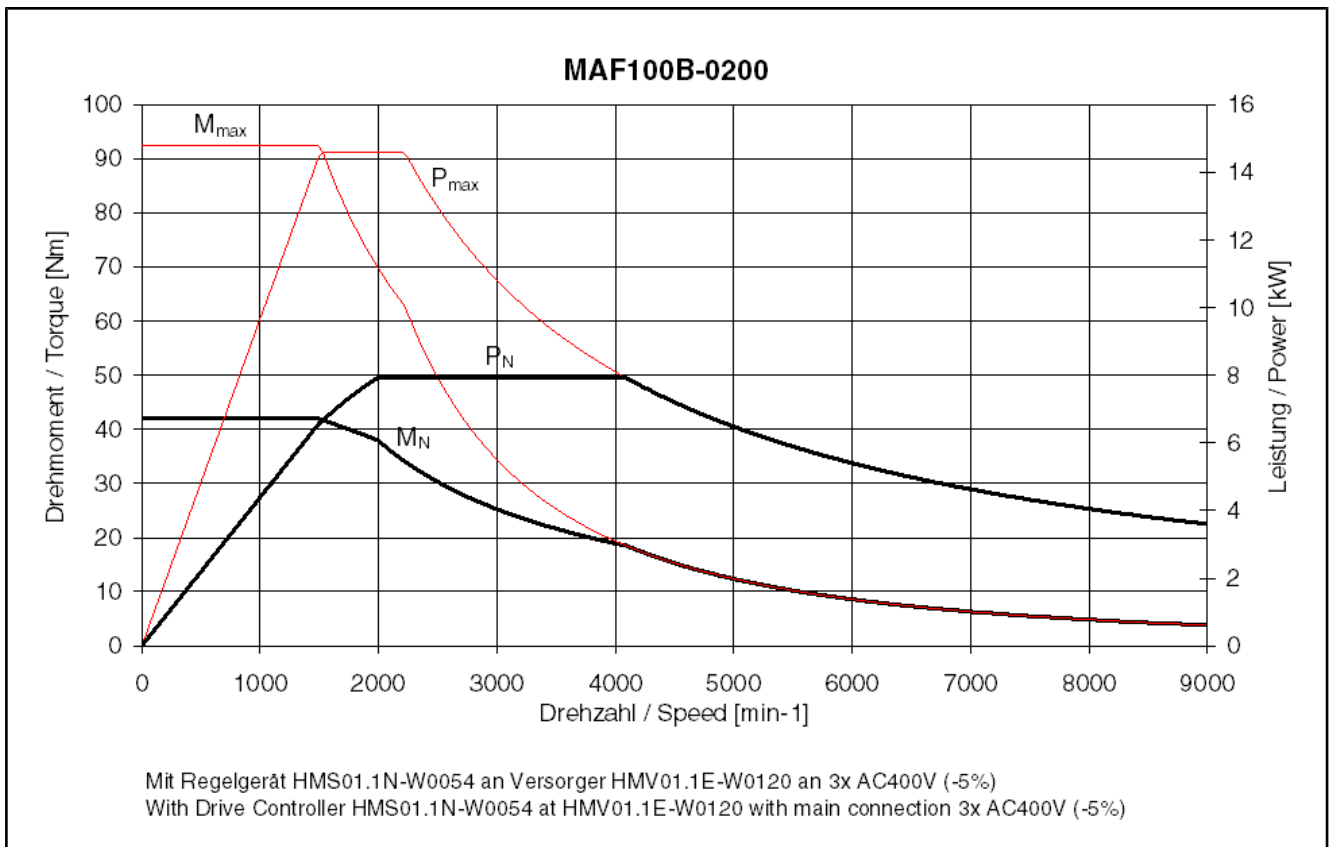

Fig.4-79: Motor characteristic curve of MAF100B-0200

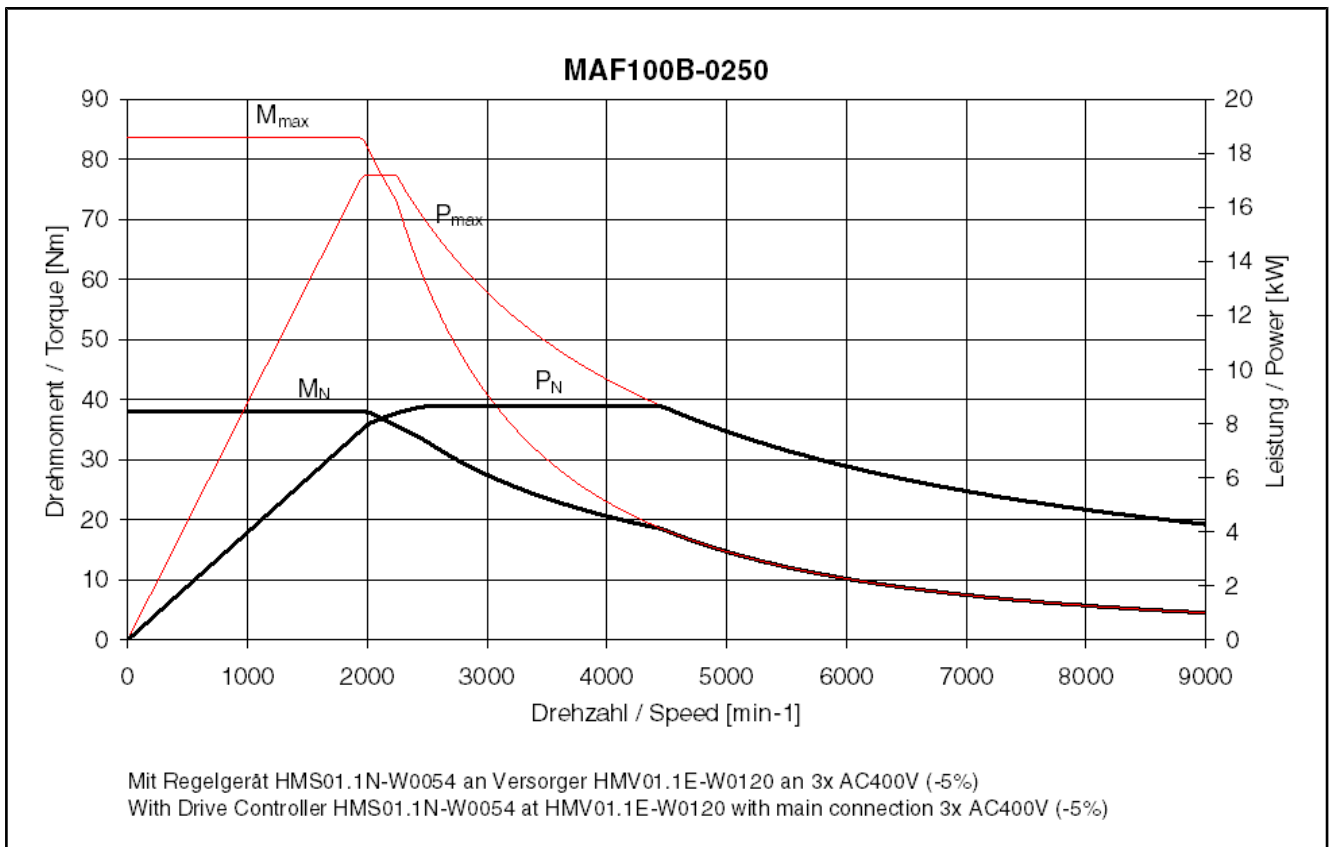

Fig.4-80: Motor characteristic curve of MAF100B-0250

Technical Data

4.8.3 Data Sheet of MAF100C

Parameter	Symbol	Unit	MAF100C				
			0050	0100	0150	0200	0250
Rated torque ¹⁾	M_N	Nm	70.0	68.0	66.0	64.0	62.0
Rated power	P_N	kW	3.90	7.50	10.40	13.40	16.23
Rated current	I_N	A	12.1	19.0	27.9	36.7	40.2
Rated speed	n_N	1/min	500	1,000	1,500	2,000	2,500
Key speed	n_1	1/min	500		1,000	1,500	2,000
Maximum torque	M_{max}	Nm	153.7	154.0	149.5	145.2	138.1
Maximum power	P_{S6max}	kW	8.00	15.38	21.32	27.47	33.27
Maximum current	$I_{max(eff)}$	A	25.6	41.4	60.4	77.5	85.8
Maximum speed with bearing A	n_{max}	1/min	3,000	6,000	9,000		
Maximum speed with bearing H	n_{max}	1/min	3,000	6,000	9,000	11,000	
Maximum speed with bearing N	n_{max}	1/min	3,000	6,000	9,000		
Continuous torque at standstill	M_{n1}	Nm	70.0		68.0	66.0	64.0
Continuous current at standstill	I_{n1}	A	12.1	19.5	28.6	37.6	38.5
Torque constant at 20 °C	$K_{M,N}$	Nm/A	6.06	3.77	2.50	1.91	1.55
Thermal time constant	T_{th}	min	3.5				
Cycle duration (S6 - 44%)	T_C	min	5				
Discharge capacity of the component	C_{ab}	nF	8.5		8.6	8.5	9.4
Number of pole pairs	p	--	3				
Power wire cross-section	A	mm ²	1.5	2.5	4.0	6.0	10.0
Mass	m_{mot}	kg	52.0				
Rotor moment of inertia	J_{rot}	kg * m ²	0.0284000				
Sound pressure level	L_P	dB[A]	70 (+3)				
Ambient air temperature during operation	T_{um}	°C	0...+40				
Insulation class according to DIN EN 60034-1	I.CL.	-	155				
Data on liquid cooling							
Power loss to be dissipated	P_V	kW	1.10		1.20	1.30	1.97
Coolant supply temperature	T_{ein}	°C	10 ... 40				
Allowed coolant temperature rise at P_V	ΔT_{max}	K	10				

Last revision: 2010-11-05

Technical Data

Parameter	Symbol	Unit	MAF100C				
			0050	0100	0150	0200	0250
Pressure drop at Q_{min}	Δp	bar	0.2		0.3		0.6
Constant for determining the pressure drop with water as cooling medium	$K_{\Delta p}$	-	0.10				
Coolant flow required at P_V	Q_{min}	l/min	1.6	1.7	1.9	2.8	
Coolant duct volume	V_{kuehl}	l	0.08				
Maximum allowed input pressure	p_{max}	bar	6.0				

Last revision: 2010-11-05

1) Please note the information on the specified parameters at the beginning of this chapter

Fig.4-81: MAF100C - Technical data

4.8.4 Motor Characteristic Curves of MAF100C

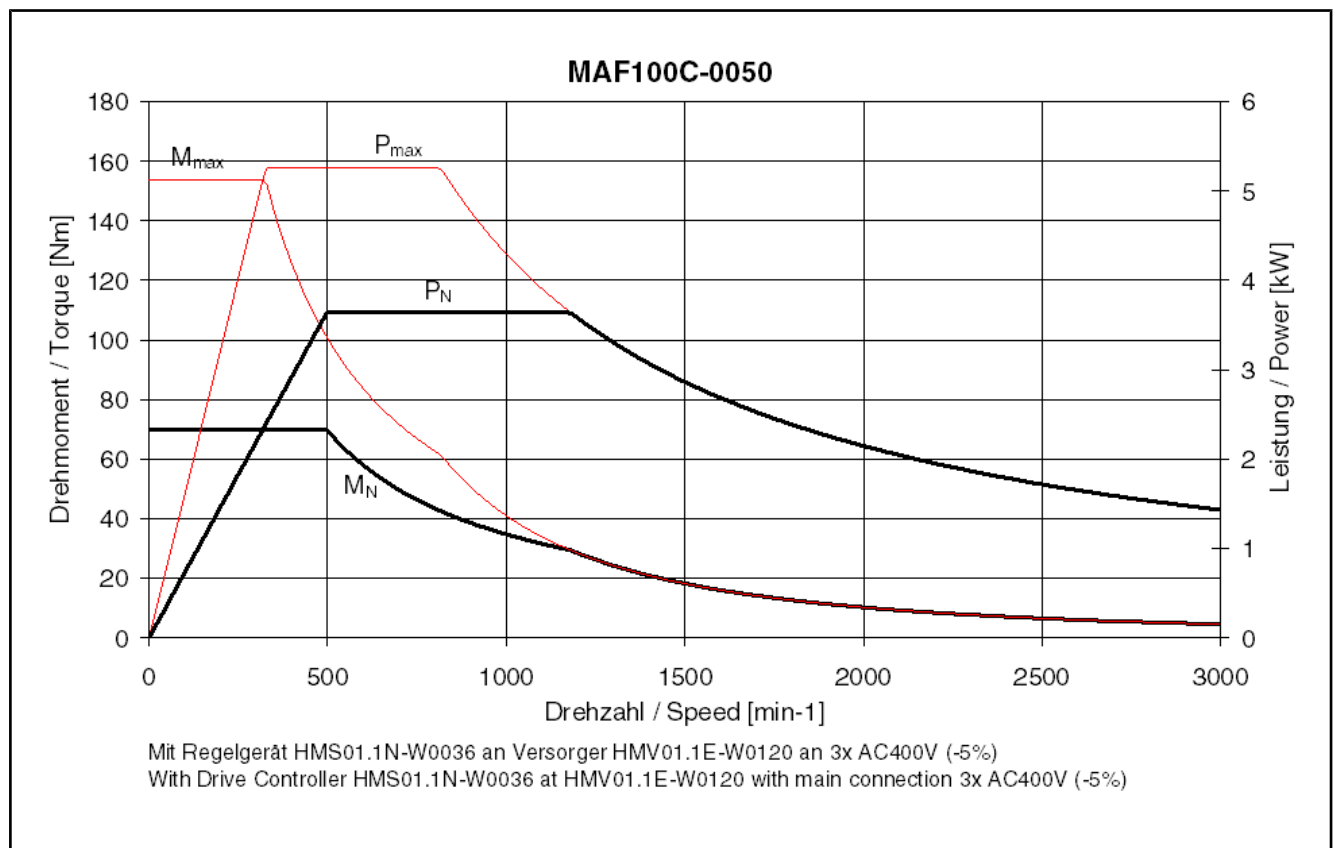

Fig.4-82: Motor characteristic curve of MAF100C-0050

Technical Data

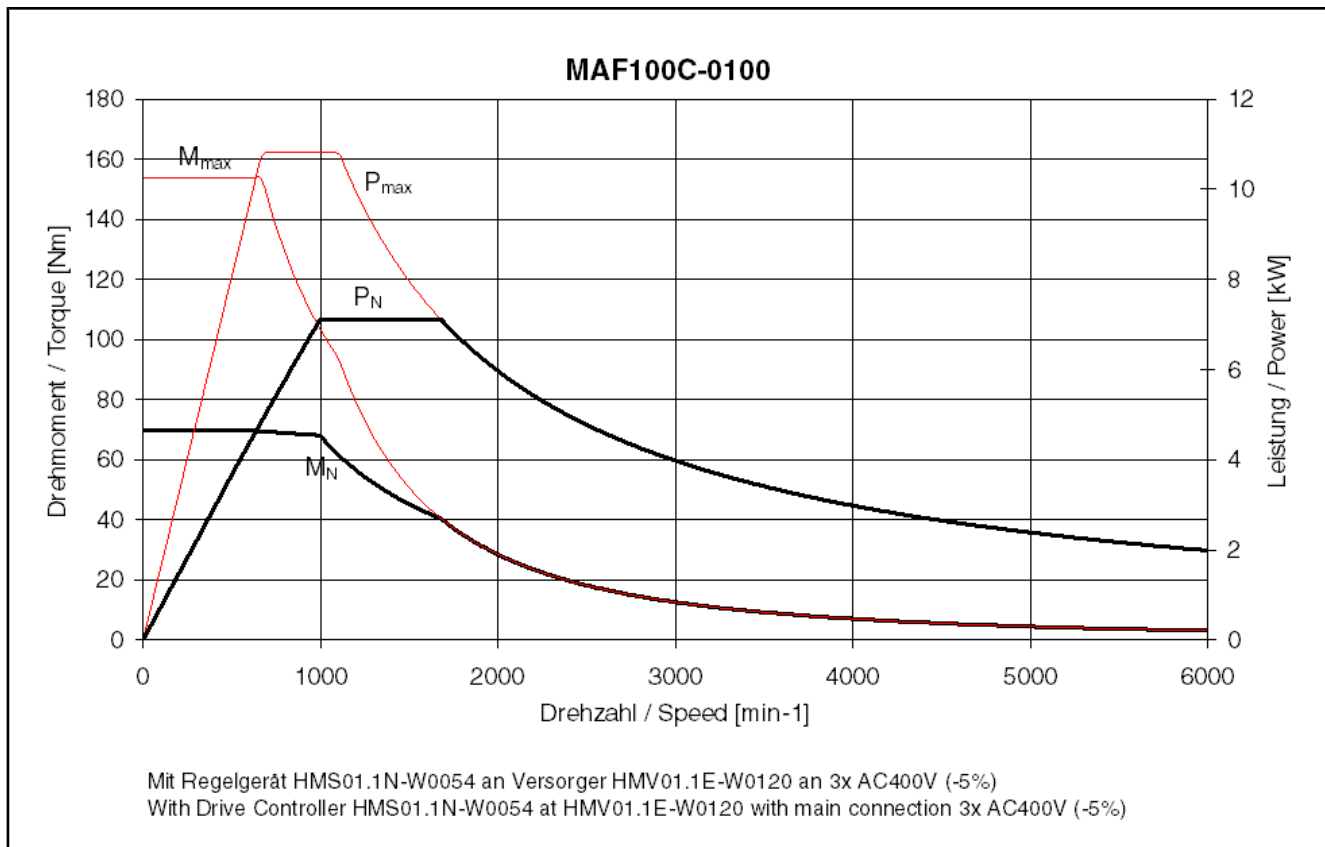

Fig.4-83: Motor characteristic curve of MAF100C-0100

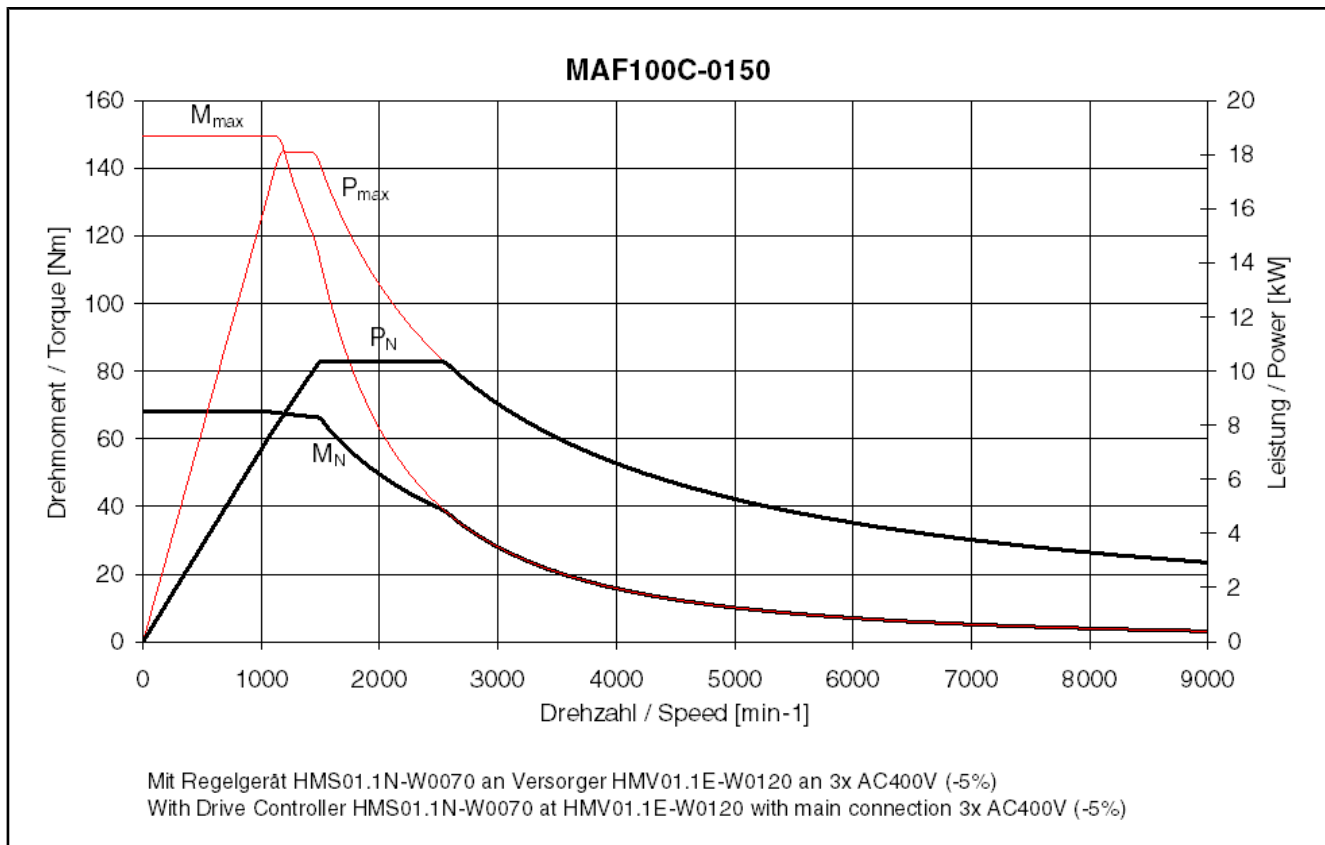

Fig.4-84: Motor characteristic curve of MAF100C-0150

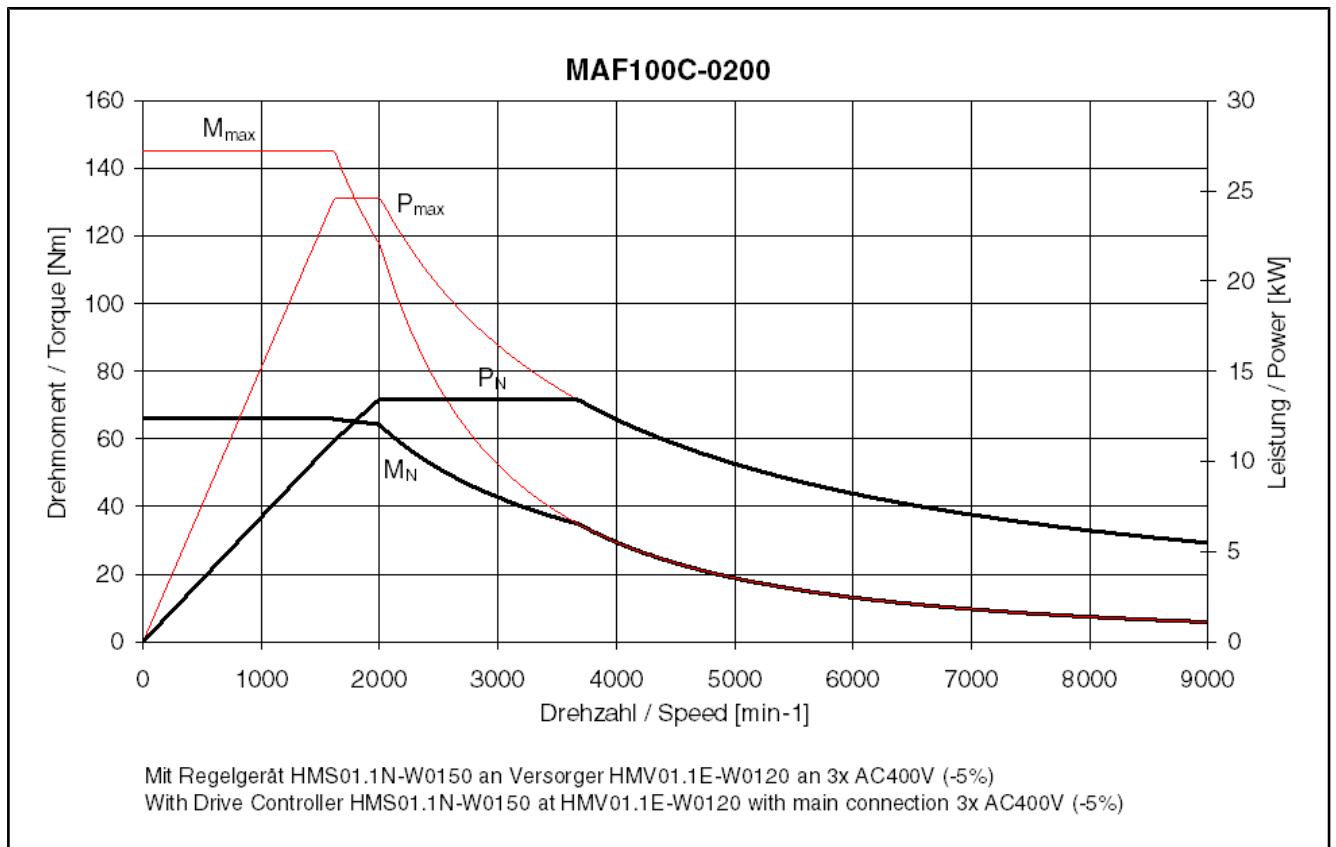

Fig.4-85: Motor characteristic curve of MAF100C-0200

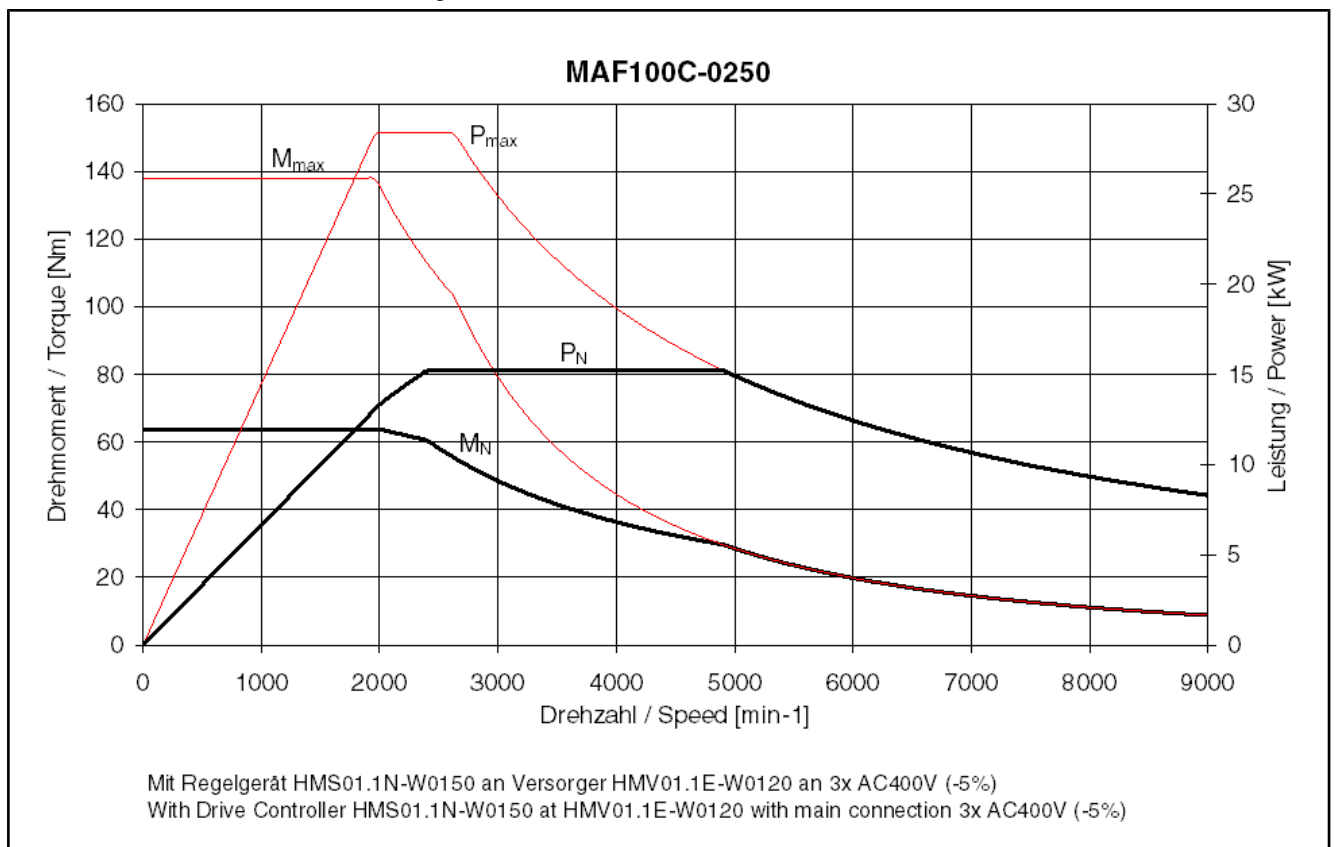

Fig.4-86: Motor characteristic curve of MAF100C-0250

Technical Data

4.8.5 Data Sheet of MAF100D

Parameter	Symbol	Unit	MAF100D				
			0050	0100	0150	0200	0250
Rated torque ¹⁾	M_N	Nm	88.0	84.0	79.0	80.0	75.0
Rated power	P_N	kW	4.60	8.80	12.40	16.76	19.63
Rated current	I_N	A	14.5	27.1	32.7	43.1	45.8
Rated speed	n_N	1/min	500	1,000	1,500	2,000	2,500
Key speed	n_1	1/min	500		1,000	1,500	2,000
Maximum torque	M_{max}	Nm	193.3	190.0	185.3	182.3	177.5
Maximum power	P_{S6max}	kW	9.43	18.00	25.42	34.35	40.24
Maximum current	$I_{max(eff)}$	A	29.2	58.0	68.7	91.3	100.4
Maximum speed with bearing A	n_{max}	1/min	3,000	6,000	9,000		
Maximum speed with bearing H	n_{max}	1/min	3,000	6,000	9,000	11,000	
Maximum speed with bearing N	n_{max}	1/min	3,000	6,000	9,000		
Continuous torque at standstill	M_{n1}	Nm	87.8	88.1	84.3	83.0	80.0
Continuous current at standstill	I_{n1}	A	14.5	27.7	34.3	44.4	56.1
Torque constant at 20 °C	$K_{M,N}$	Nm/A	6.79	3.51	2.77	2.04	1.55
Thermal time constant	T_{th}	min	3.5				
Cycle duration (S6 - 44%)	T_C	min	5				
Discharge capacity of the component	C_{ab}	nF	11.0	11.2	11.0	10.0	9.2
Number of pole pairs	p	--	3				
Power wire cross-section	A	mm ²	1.5	4.0	6.0	10.0	
Mass	m_{mot}	kg	64.0				
Rotor moment of inertia	J_{rot}	kg * m ²	0.0320000				
Sound pressure level	L_P	dB[A]	70 (+3)				
Ambient air temperature during operation	T_{um}	°C	0...+40				
Insulation class according to DIN EN 60034-1	I.CL.	-	155				
Data on liquid cooling							
Power loss to be dissipated	P_V	kW	1.40	1.65	1.70	1.74	1.94
Coolant supply temperature	T_{ein}	°C	10 ... 40				

Last revision: 2010-11-05

Technical Data

Parameter	Symbol	Unit	MAF100D				
			0050	0100	0150	0200	0250
Allowed coolant temperature rise at P_V	ΔT_{max}	K	10				
Pressure drop at Q_{min}	Δp	bar	0.5	0.6	0.7		0.8
Constant for determining the pressure drop with water as cooling medium	$K_{\Delta p}$	-	0.14				
Coolant flow required at P_V	Q_{min}	l/min	2.0	2.4		2.5	2.8
Coolant duct volume	V_{kuehl}	l	0.11				
Maximum allowed input pressure	p_{max}	bar	6.0				

Last revision: 2010-11-05

1) Please note the information on the specified parameters at the beginning of this chapter

Fig.4-87: MAF100D - Technical data

4.8.6 Motor Characteristic Curves of MAF100D

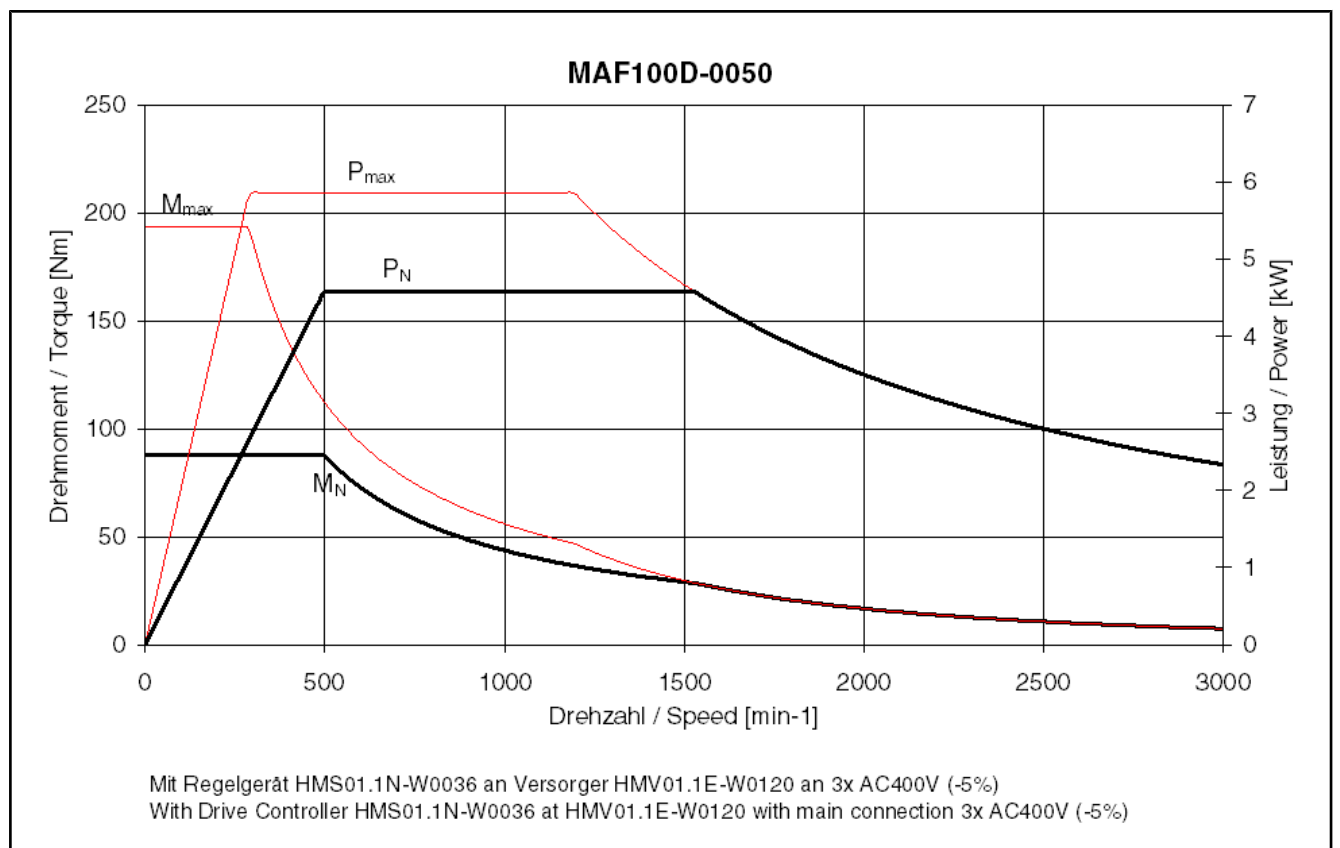

Fig.4-88: Motor characteristic curve of MAF100D-0050

Technical Data

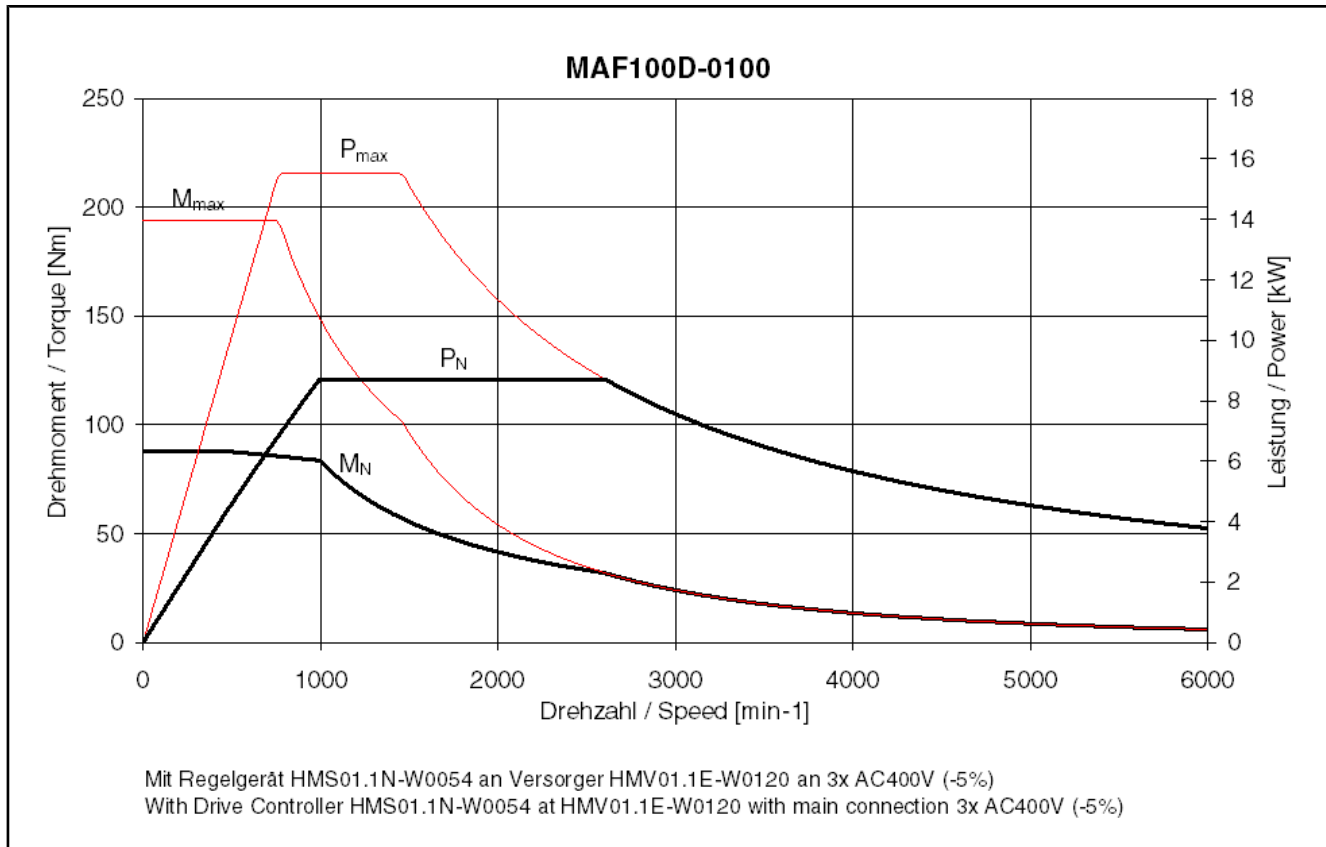

Fig.4-89: Motor characteristic curve of MAF100D-0100

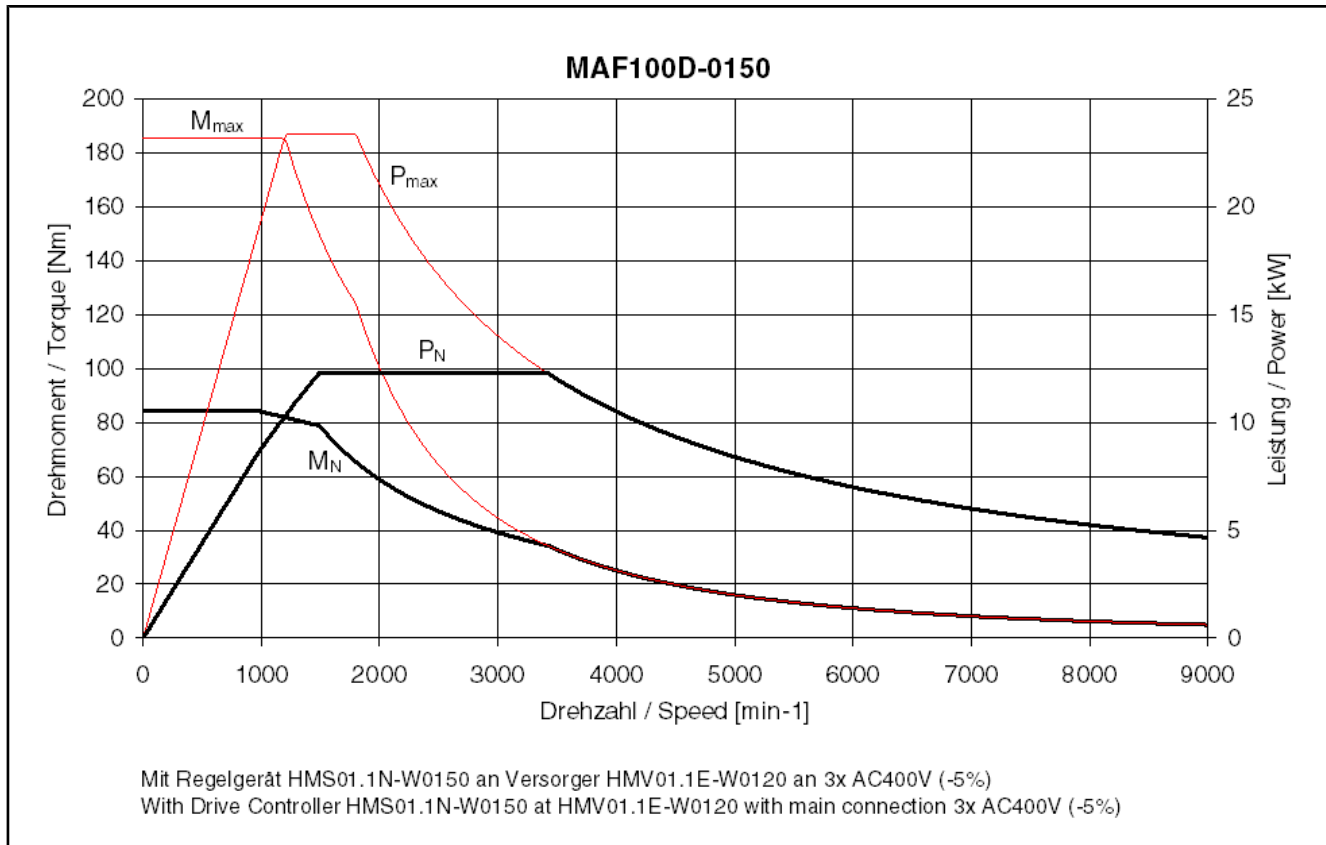

Fig.4-90: Motor characteristic curve of MAF100D-0150

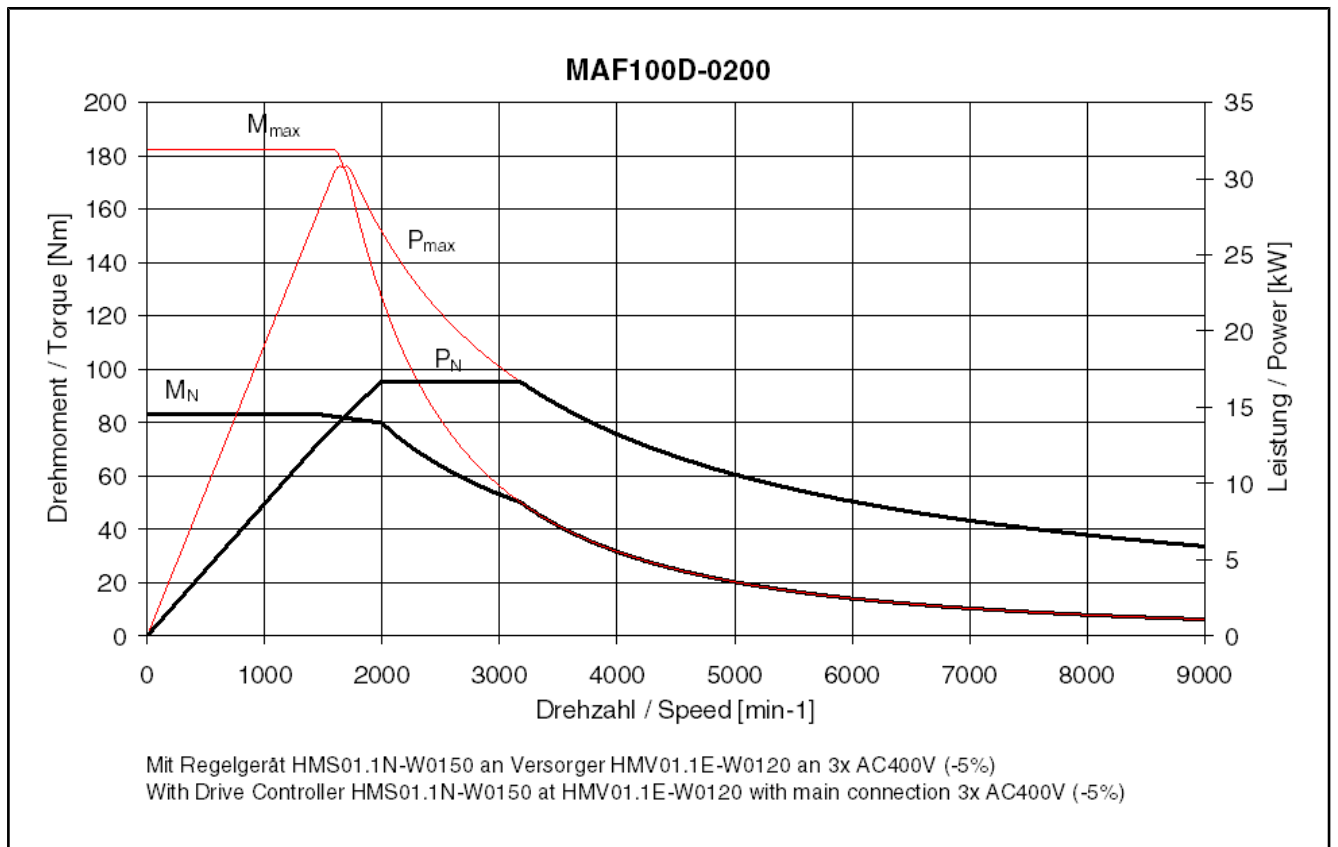

Fig.4-91: Motor characteristic curve of MAF100D-0200

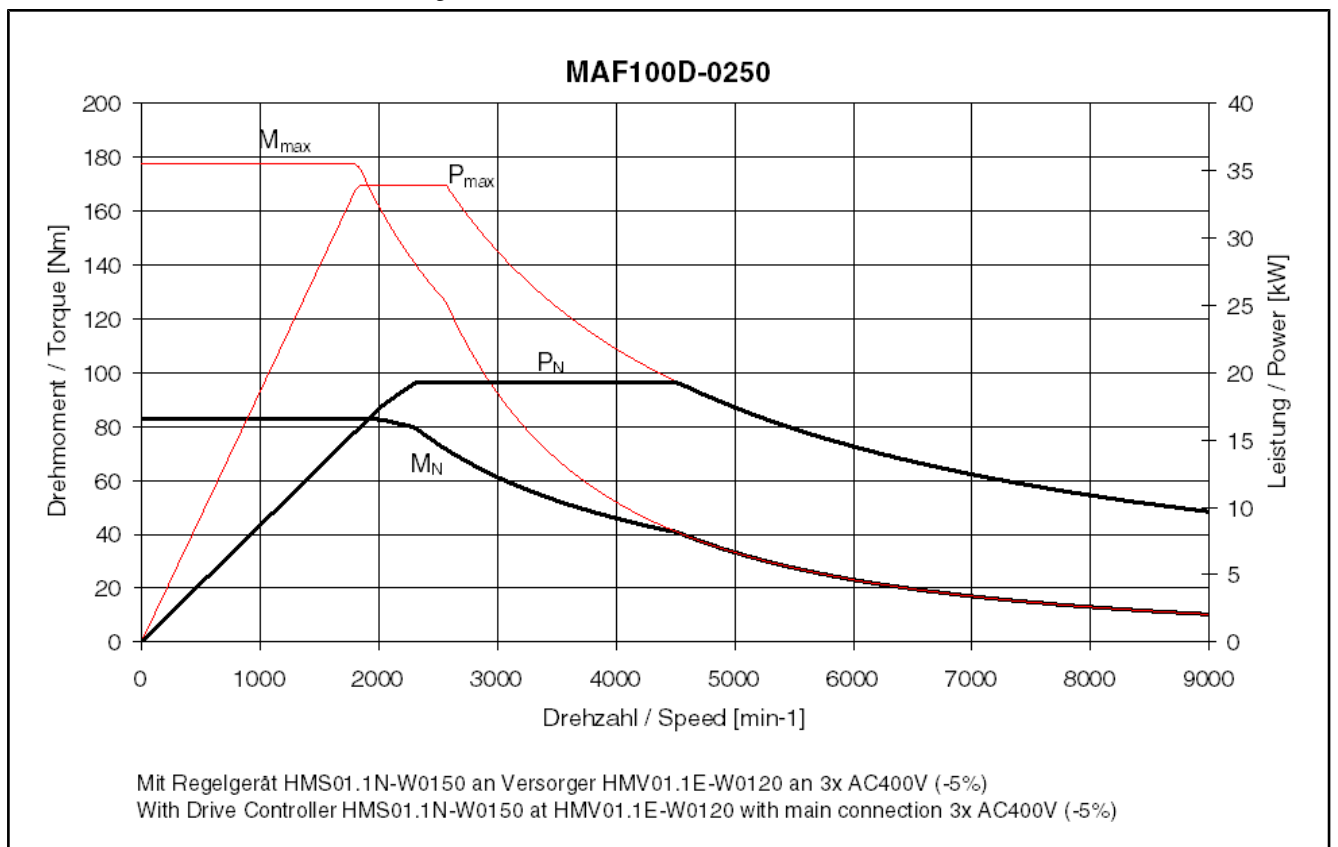

Fig.4-92: Motor characteristic curve of MAF100D-0250

Technical Data

4.8.7 Holding Brake MAD/MAF100 (Optional)

Data sheet - holding brake MAD/MAF100

Designation	Symbol	Unit	BRAKE 5 Electrically clamping	BRAKE 1 Electrically releasing
Holding torque	M_4	Nm	30.0	24.0
Rated voltage	U_N	V	24	
Rated current	I_N	A	0.90	1.10
Holding brake moment of inertia	J_{br}	kg*m ²	0.000529	0.000556
Connection time	t_1	ms	42	30
Disconnection time	t_2	ms	50	90
Maximum holding brake speed	n_{Br_max}	min ⁻¹	10000	
Last revision: 2006-10-23				

Fig.4-93: Technical data of holding brake MAD/MAF100 (optional)

Technical Data

Technical Data

4.9 Technical Data of MAF130

4.9.1 Data Sheet of MAF130B

Parameter	Symbol	Unit	MAF130B				
			0050	0100	0150	0200	0250
Rated torque ¹⁾	M_N	Nm	116.0	112.0	115.0	100.0	90.0
Rated power	P_N	kW	6.10	11.70	18.10	20.90	23.56
Rated current	I_N	A	14.7	28.4	43.7	52.7	58.8
Rated speed	n_N	1/min	500	1,000	1,500	2,000	2,500
Key speed	n_1	1/min	500		1,000	1,500	2,000
Maximum torque	M_{max}	Nm	254.7		264.0	220.0	210.0
Maximum power	P_{S6max}	kW	12.51	23.99	37.11	42.85	48.30
Maximum current	$I_{max(eff)}$	A	30.5	61.0	94.7	108.9	126.6
Maximum speed with bearing A	n_{max}	1/min	3,000	6,000	7,500		
Maximum speed with bearing H	n_{max}	1/min	3,000	6,000	9,000	10,000	
Maximum speed with bearing N	n_{max}	1/min	3,000	6,000	7,500		
Maximum speed with bearing V	n_{max}	1/min	3,000	6,000	7,500		
Continuous torque at standstill	M_{n1}	Nm	115.8		120.0	108.0	95.0
Continuous current at standstill	I_{n1}	A	14.6	29.3	45.3	53.0	61.2
Torque constant at 20 °C	K_{M_N}	Nm/A	8.46	4.25	2.83	2.07	1.77
Thermal time constant	T_{th}	min	3.5				
Cycle duration (S6 - 44%)	T_C	min	5				
Discharge capacity of the component	C_{ab}	nF	16.0			11.6	13.2
Number of pole pairs	p	--	3				
Power wire cross-section	A	mm ²	1.5	4.0	10.0		16.0
Mass	m_{mot}	kg	82.0				
Rotor moment of inertia	J_{rot}	kg * m ²	0.0790000				
Sound pressure level	L_P	dB[A]	70 (+3)				
Ambient air temperature during operation	T_{um}	°C	0...+40				
Insulation class according to DIN EN 60034-1	I.CL.	-	155				
Data on liquid cooling							
Power loss to be dissipated	P_V	kW	1.80	1.90	2.00	2.23	
Coolant supply temperature	T_{ein}	°C	10 ... 40				

Last revision: 2010-11-05

Parameter	Symbol	Unit	MAF130B				
			0050	0100	0150	0200	0250
Allowed coolant temperature rise at P_V	ΔT_{max}	K	10				
Pressure drop at Q_{min}	Δp	bar	0.1				
Constant for determining the pressure drop with water as cooling medium	$K_{\Delta p}$	-	0.02				
Coolant flow required at P_V	Q_{min}	l/min	2.6	2.7	2.9	3.2	
Coolant duct volume	V_{kuehl}	l	0.15				
Maximum allowed input pressure	p_{max}	bar	6.0				

Last revision: 2010-11-05

1) Please note the information on the specified parameters at the beginning of this chapter

Fig.4-94: MAF130B - Technical data

4.9.2 Motor Characteristic Curves of MAF130B

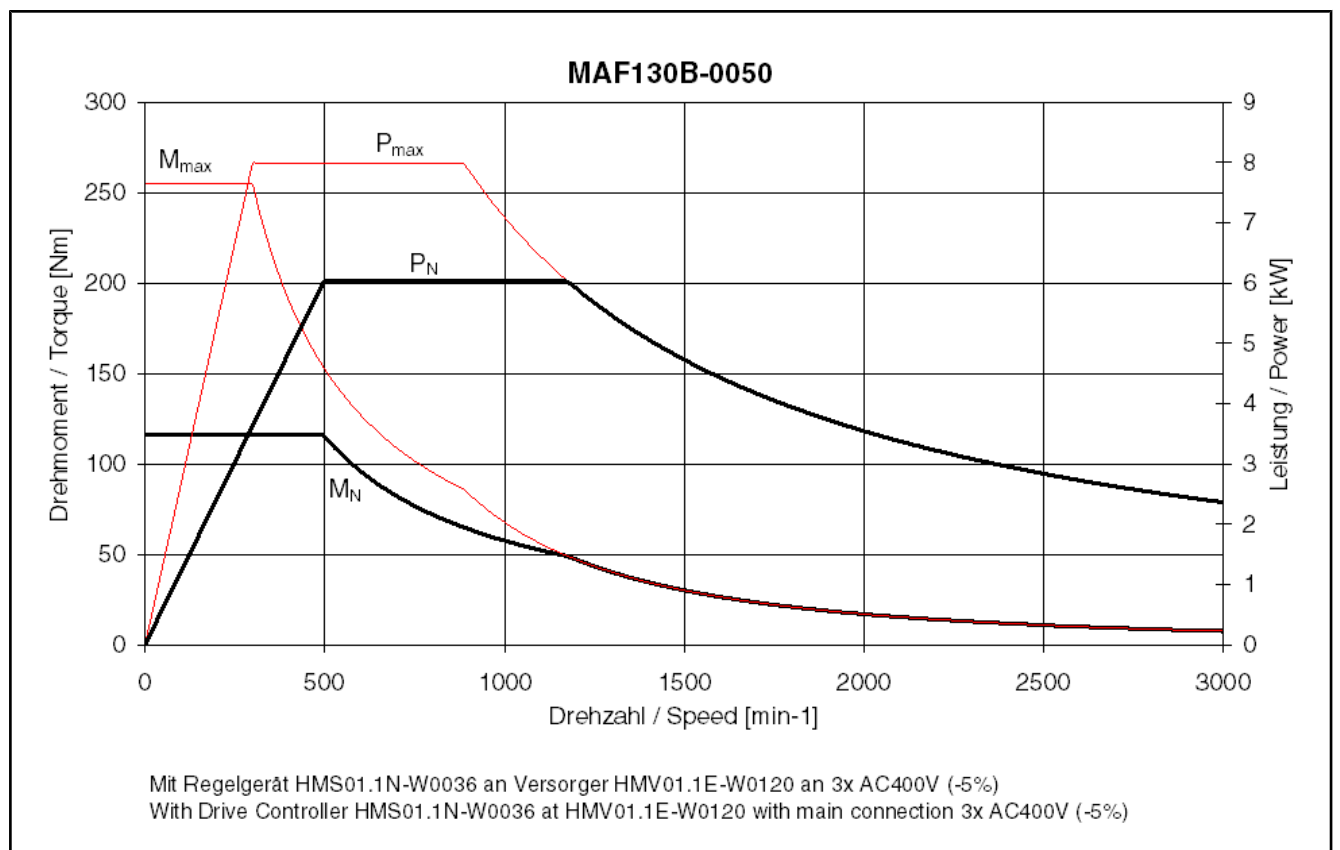

Fig.4-95: Motor characteristic curve of MAF130B-0050

Technical Data

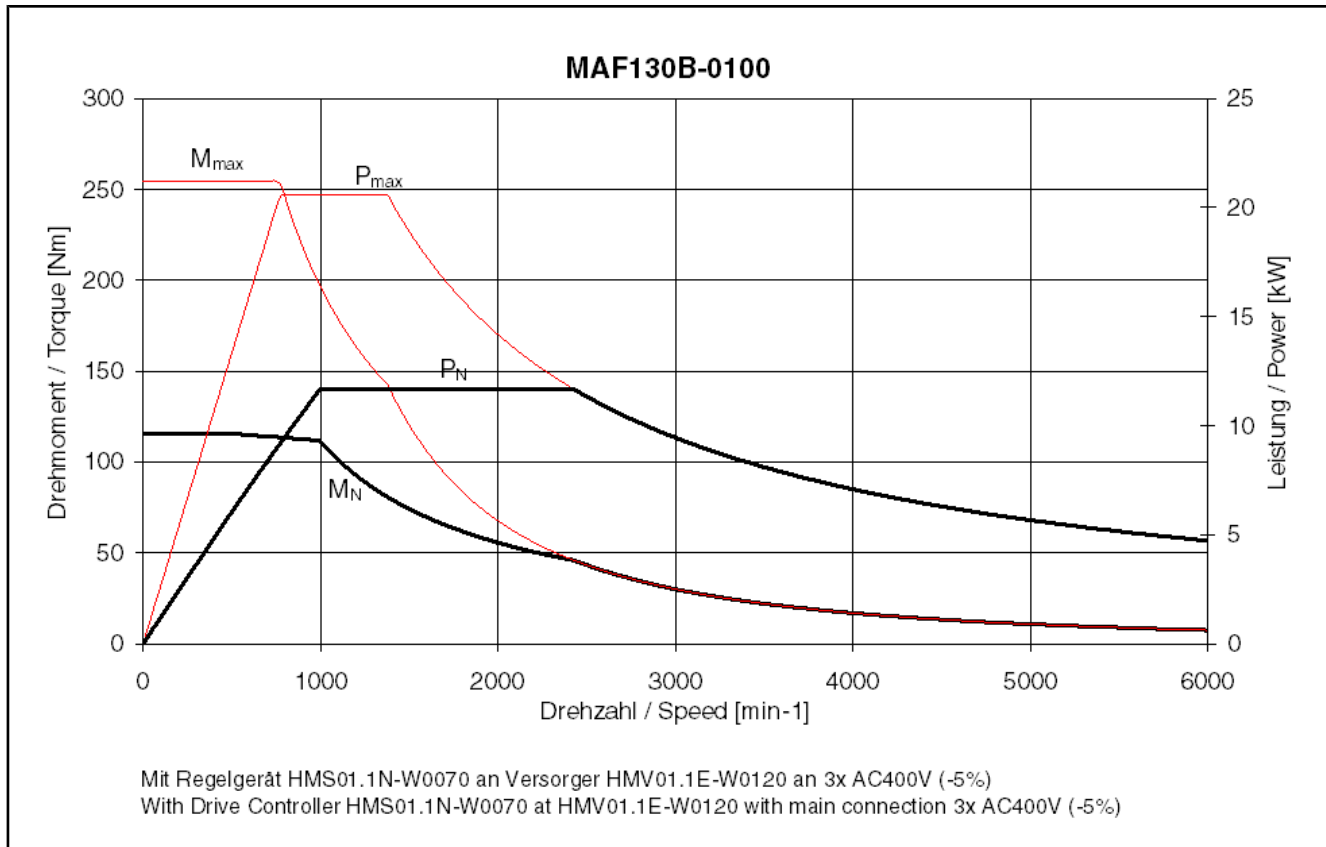

Fig.4-96: Motor characteristic curve of MAF130B-0100

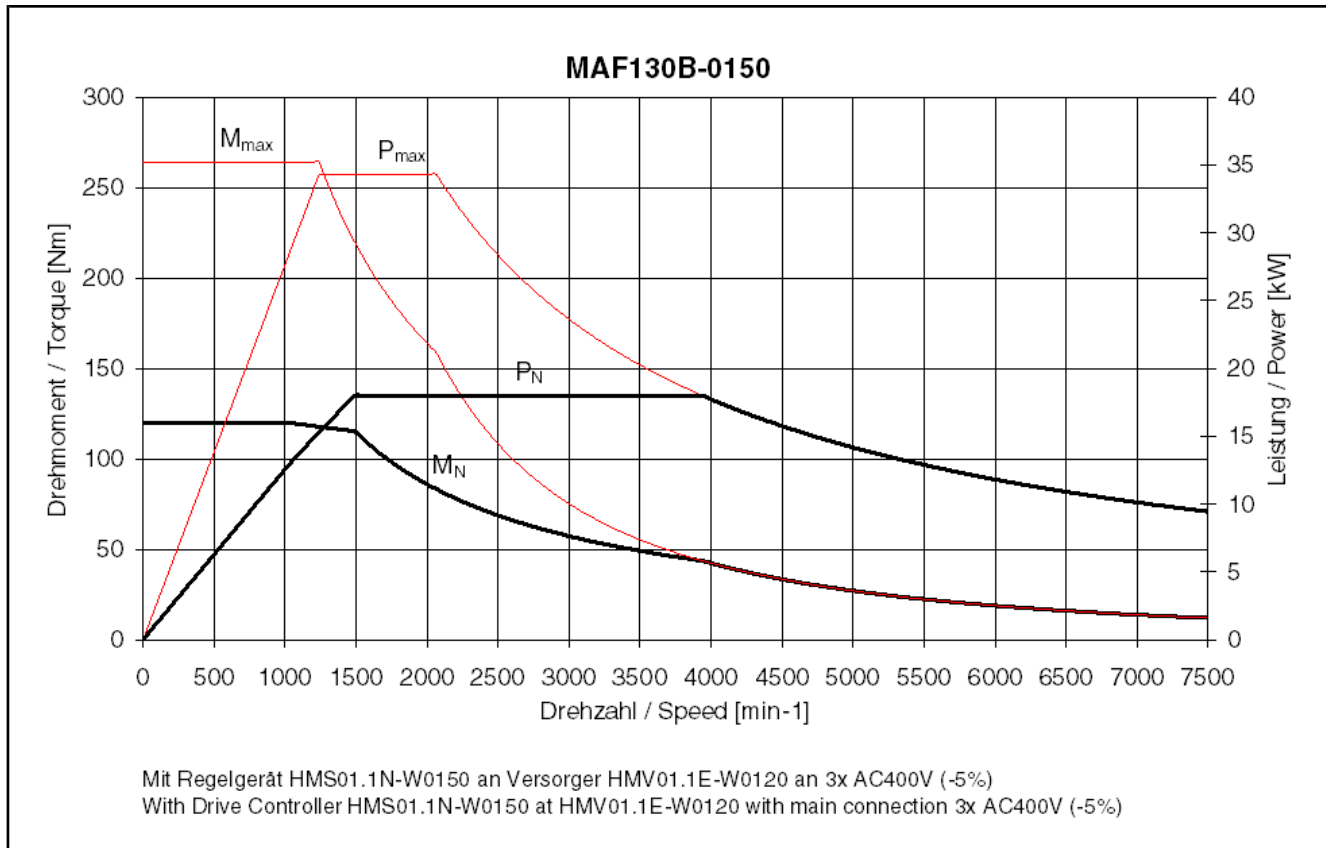

Fig.4-97: Motor characteristic curve of MAF130B-0150

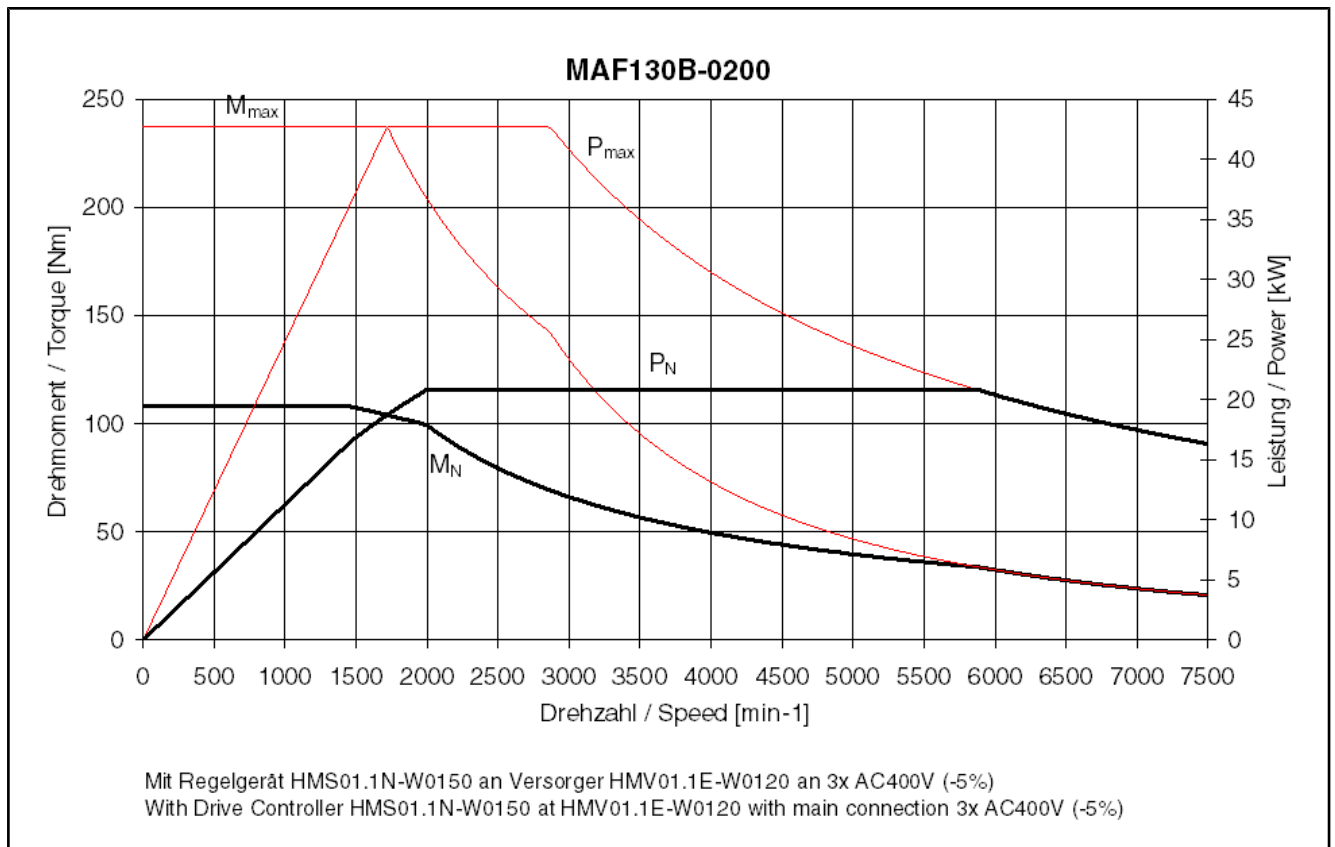

Fig.4-98: Motor characteristic curve of MAF130B-0200

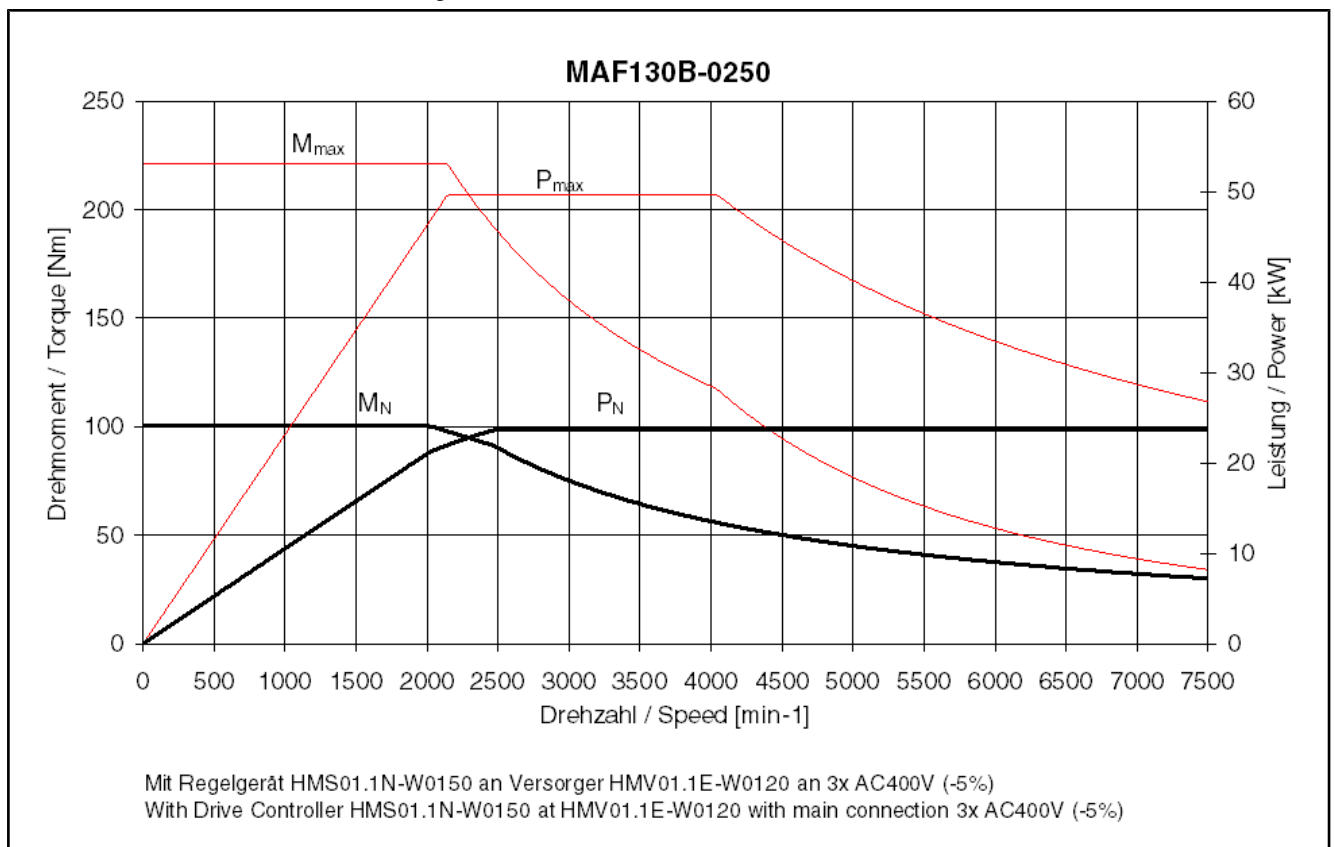

Fig.4-99: Motor characteristic curve of MAF130B-0250

Technical Data

4.9.3 Data Sheet of MAF130C

Parameter	Symbol	Unit	MAF130C				
			0050	0100	0150	0200	0250
Rated torque ¹⁾	M_N	Nm	155.0	150.0	145.0	135.0	125.0
Rated power	P_N	kW	8.10	15.70	22.80	28.30	32.72
Rated current	I_N	A	21.0	38.0	53.2	69.8	75.5
Rated speed	n_N	1/min	500	1,000	1,500	2,000	2,500
Key speed	n_1	1/min	500		1,000	1,500	2,000
Maximum torque	M_{max}	Nm	340.0	330.0	329.8	314.7	298.4
Maximum power	P_{S6max}	kW	16.61	32.19	46.74	58.02	67.08
Maximum current	$I_{max(eff)}$	A	42.6	71.8	111.0	142.9	150.8
Maximum speed with bearing A	n_{max}	1/min	3,000	6,000	7,500		
Maximum speed with bearing H	n_{max}	1/min	3,000	6,000	9,000	10,000	
Maximum speed with bearing N	n_{max}	1/min	3,000	6,000	7,500		
Maximum speed with bearing V	n_{max}	1/min	3,000	6,000	7,500		
Continuous torque at standstill	M_{n1}	Nm	154.7		149.9	143.0	135.0
Continuous current at standstill	I_{n1}	A	20.8	39.0	54.7	71.2	75.5
Torque constant at 20 °C	K_{M-N}	Nm/A	8.04	5.09	3.04	2.19	1.88
Thermal time constant	T_{th}	min	3.5				
Cycle duration (S6 - 44%)	T_C	min	5				
Discharge capacity of the component	C_{ab}	nF	20.0	15.4	20.0	16.8	20.0
Number of pole pairs	p	--	3				
Power wire cross-section	A	mm ²	2.5	6.0	16.0		25.0
Mass	m_{mot}	kg	106.0				
Rotor moment of inertia	J_{rot}	kg * m ²	0.1010000				
Sound pressure level	L_P	dB[A]	70 (+3)				
Ambient air temperature during operation	T_{um}	°C	0...+40				
Insulation class according to DIN EN 60034-1	I.CL.	-	155				
Data on liquid cooling							
Power loss to be dissipated	P_V	kW	2.20	2.28	2.30		2.35
Coolant supply temperature	T_{ein}	°C	10 ... 40				

Last revision: 2010-11-05

Technical Data

Parameter	Symbol	Unit	MAF130C				
			0050	0100	0150	0200	0250
Allowed coolant temperature rise at P_V	ΔT_{max}	K	10				
Pressure drop at Q_{min}	Δp	bar	0.2				
Constant for determining the pressure drop with water as cooling medium	$K_{\Delta p}$	-	0.02				
Coolant flow required at P_V	Q_{min}	l/min	3.1		3.3		3.4
Coolant duct volume	V_{kuehl}	l	0.20				
Maximum allowed input pressure	p_{max}	bar	6.0				

Last revision: 2010-11-05

1) Please note the information on the specified parameters at the beginning of this chapter

Fig.4-100: MAF130C - Technical data

4.9.4 Motor Characteristic Curves of MAF130C

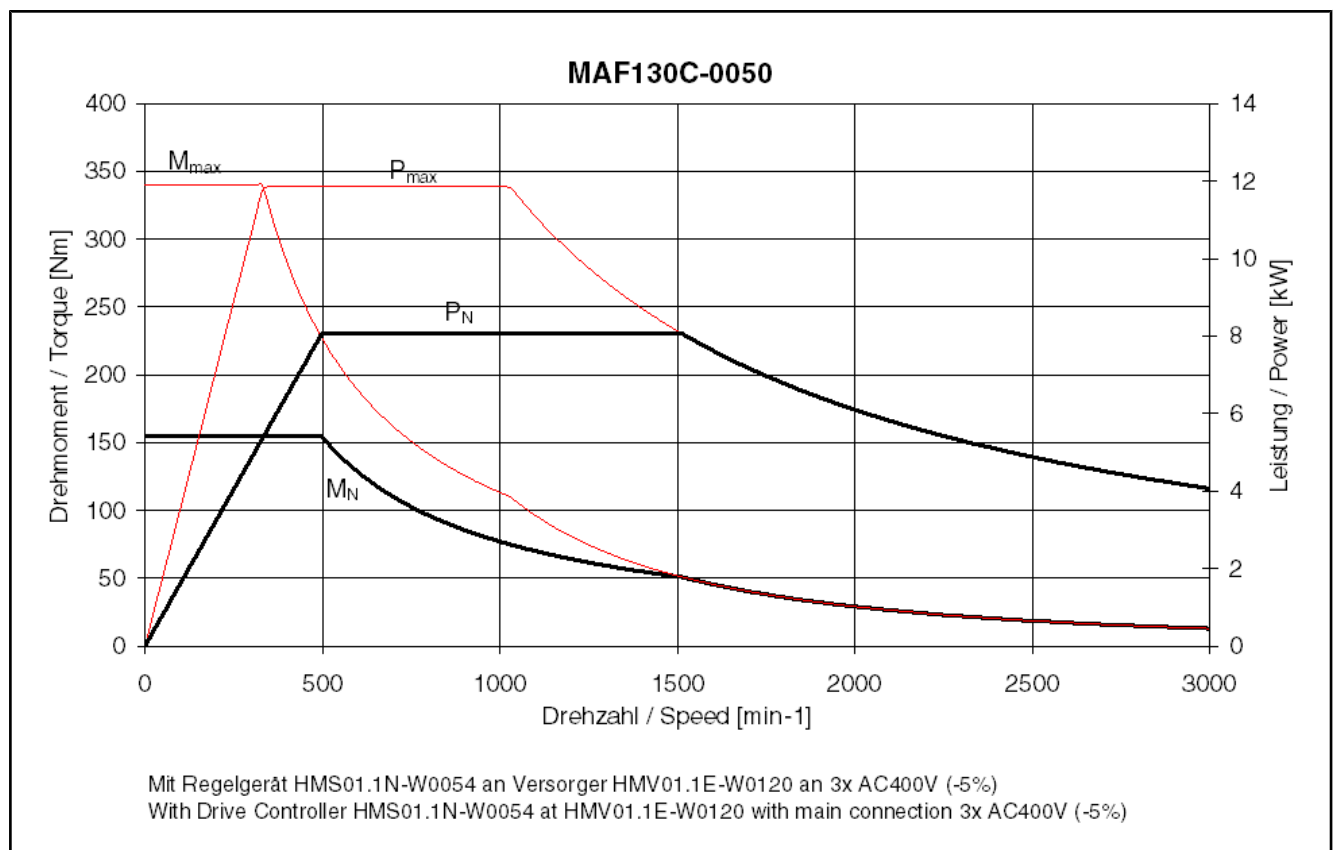

Fig.4-101: Motor characteristic curve of MAF130C-0050

Technical Data

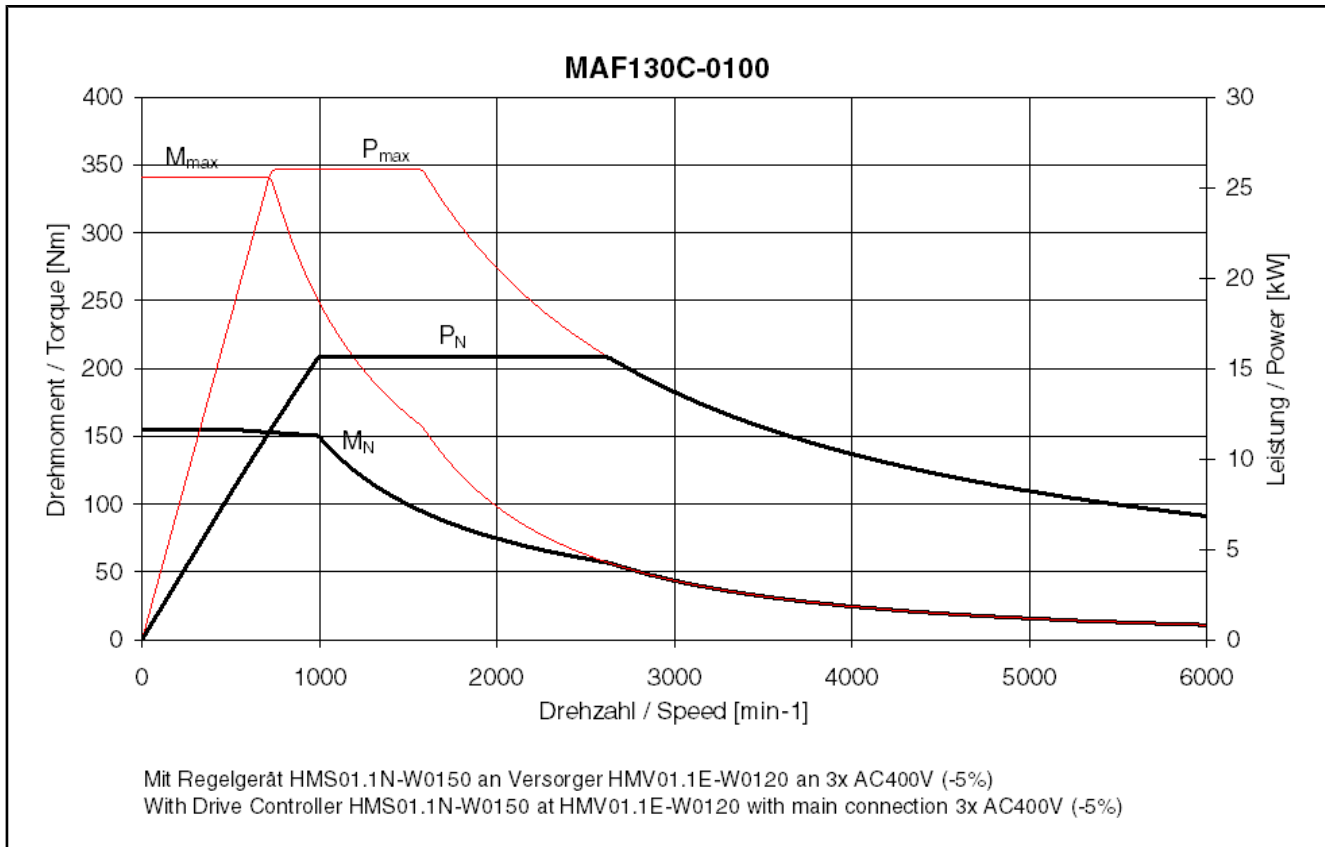

Fig.4-102: Motor characteristic curve of MAF130C-0100

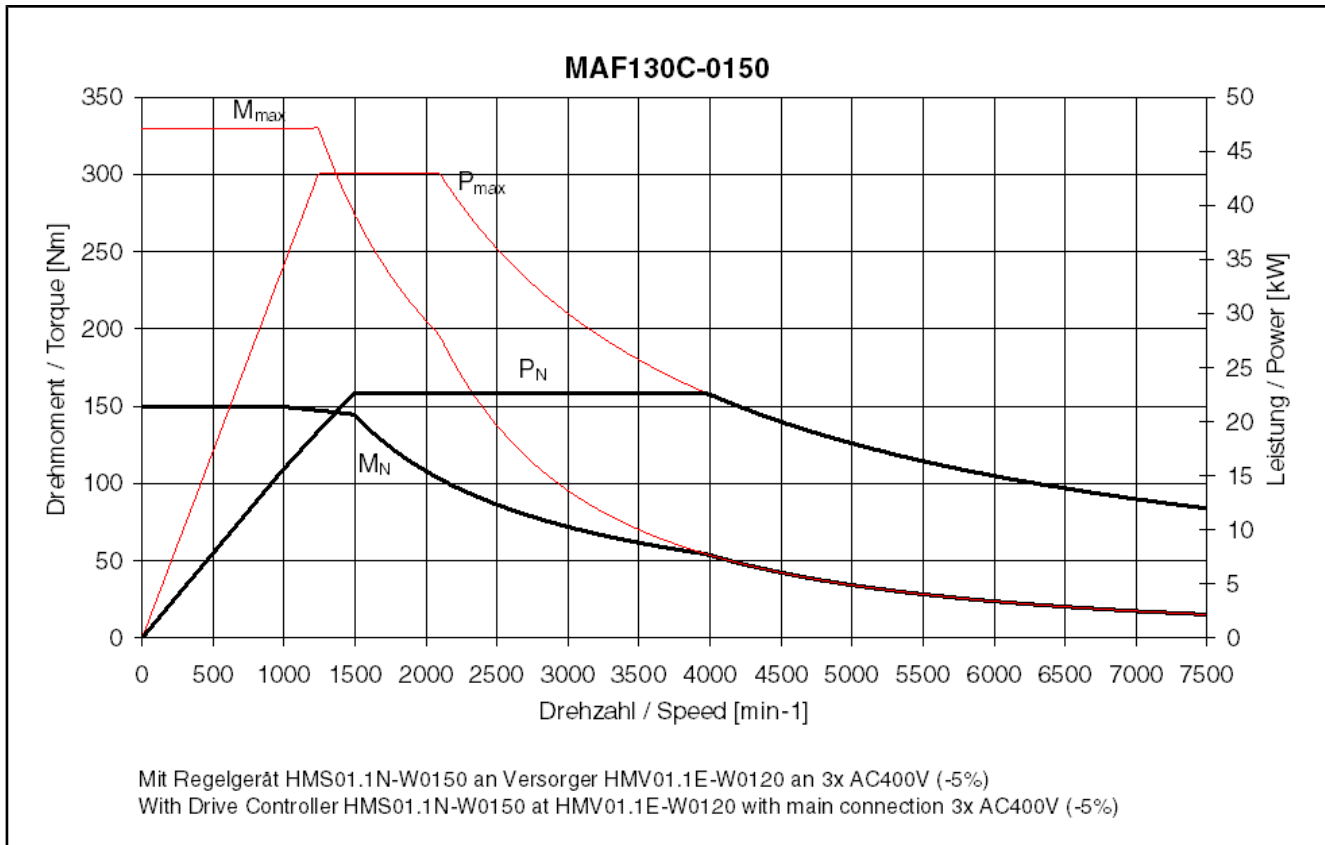

Fig.4-103: Motor characteristic curve of MAF130C-0150

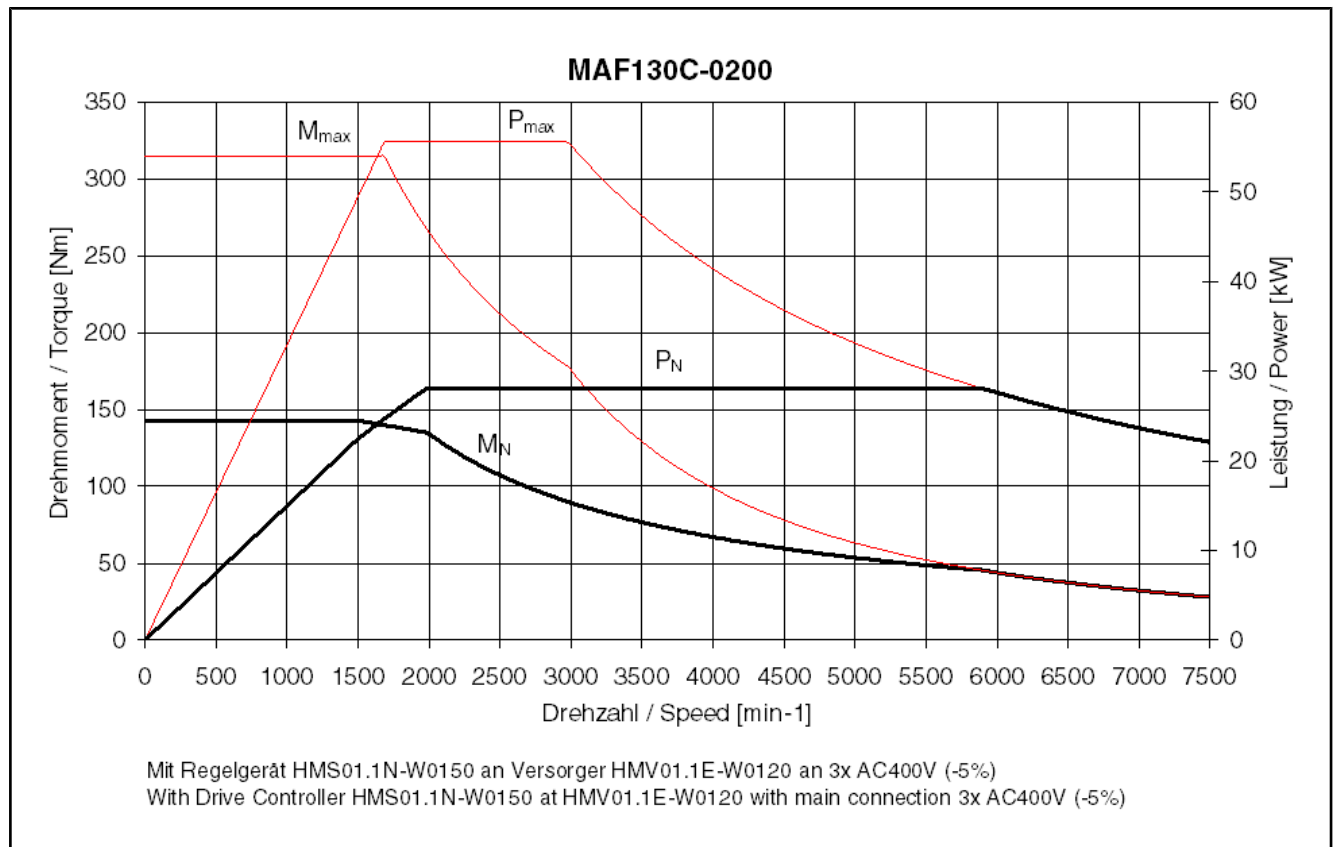

Fig.4-104: Motor characteristic curve of MAF130C-0200

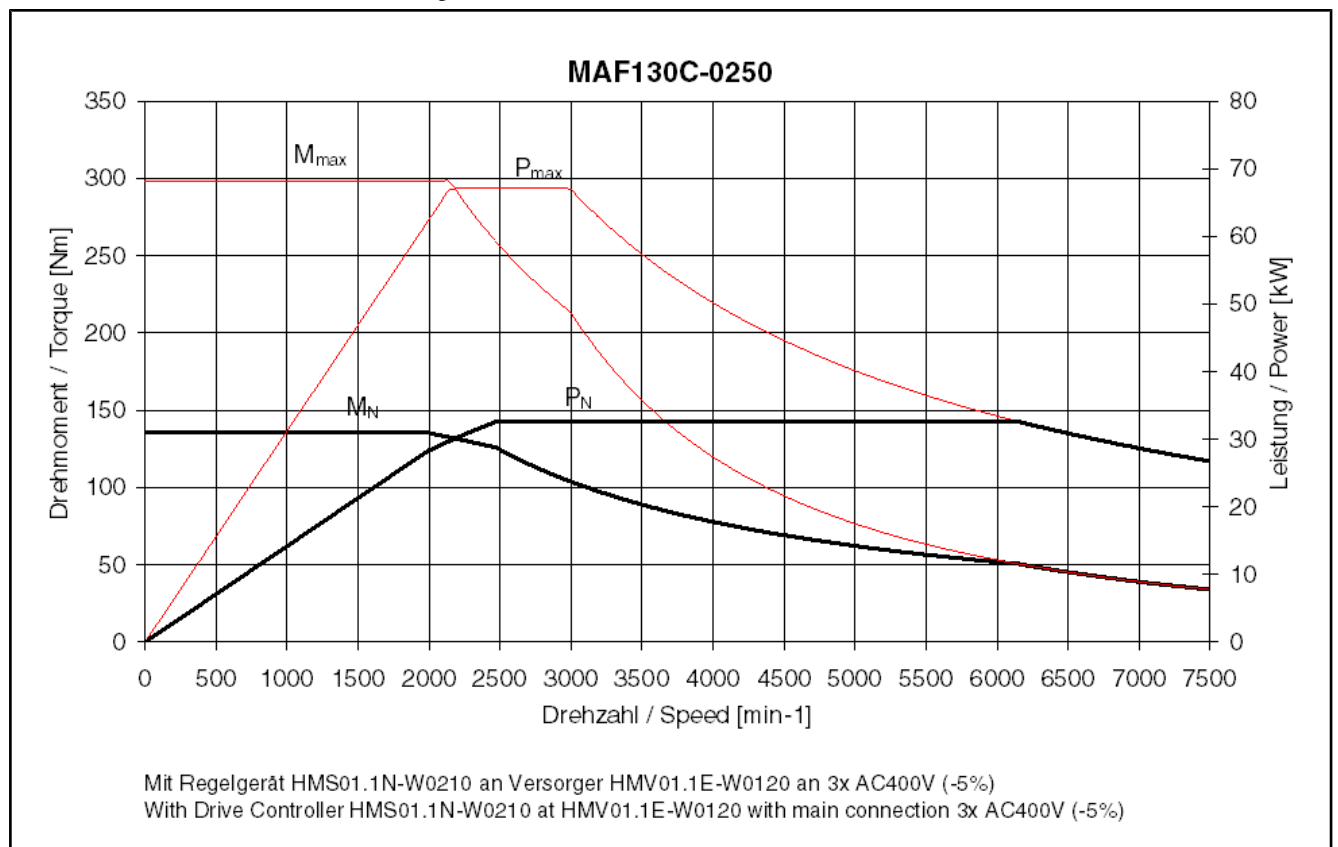

Fig.4-105: Motor characteristic curve of MAF130C-0250

Technical Data

4.9.5 Data Sheet of MAF130D

Parameter	Symbol	Unit	MAF130D				
			0050	0100	0150	0200	0250
Rated torque ¹⁾	M_N	Nm	230.0	220.0	200.0		190.0
Rated power	P_N	kW	12.00	23.04	31.40	41.90	49.74
Rated current	I_N	A	32.3	50.7	72.6	93.9	113.0
Rated speed	n_N	1/min	500	1,000	1,500	2,000	2,500
Key speed	n_1	1/min	500		1,000	1,500	2,000
Maximum torque	M_{max}	Nm	506.3	500.0	484.4	461.4	450.0
Maximum power	P_{S6max}	kW	24.60	47.23	64.37	85.90	140.00
Maximum current	$I_{max(eff)}$	A	64.3	109.1	155.4	190.9	238.0
Maximum speed with bearing A	n_{max}	1/min	3,000	6,000	7,500		
Maximum speed with bearing H	n_{max}	1/min	3,000	6,000	9,000	10,000	
Maximum speed with bearing N	n_{max}	1/min	3,000	6,000	7,500		
Maximum speed with bearing V	n_{max}	1/min	3,000	6,000	7,500		
Continuous torque at standstill	M_{n1}	Nm	230.0	229.8	220.2	210.0	195.0
Continuous current at standstill	I_{n1}	A	31.3	52.4	78.0	97.5	113.0
Torque constant at 20 °C	$K_{M,N}$	Nm/A	7.71	4.97	3.21	2.51	1.71
Thermal time constant	T_{th}	min	3.5				
Cycle duration (S6 - 44%)	T_C	min	5				
Discharge capacity of the component	C_{ab}	nF	27.5	26.7	27.5	25.1	28.6
Number of pole pairs	p	--	3				
Power wire cross-section	A	mm ²	6.0	10.0	25.0		35.0
Mass	m_{mot}	kg	147.0				
Rotor moment of inertia	J_{rot}	kg * m ²	0.1510000				
Sound pressure level	L_P	dB[A]	70 (+3)				
Ambient air temperature during operation	T_{um}	°C	0...+40				
Insulation class according to DIN EN 60034-1	I.CL.	-	155				
Data on liquid cooling							
Power loss to be dissipated	P_V	kW	3.25	3.21	3.30	3.35	3.49
Coolant supply temperature	T_{ein}	°C	10 ... 40				

Last revision: 2010-11-05

Technical Data

Parameter	Symbol	Unit	MAF130D				
			0050	0100	0150	0200	0250
Allowed coolant temperature rise at P_V	ΔT_{max}	K	10				
Pressure drop at Q_{min}	Δp	bar	0.3		0.4		
Constant for determining the pressure drop with water as cooling medium	$K_{\Delta p}$	-	0.02				
Coolant flow required at P_V	Q_{min}	l/min	4.6	4.7	4.8	5.0	
Coolant duct volume	V_{kuehl}	l	0.29				
Maximum allowed input pressure	p_{max}	bar	6.0				

Last revision: 2010-11-05

1) Please note the information on the specified parameters at the beginning of this chapter

Fig.4-106: MAF130D - Technical data

4.9.6 Motor Characteristic Curves of MAF130D

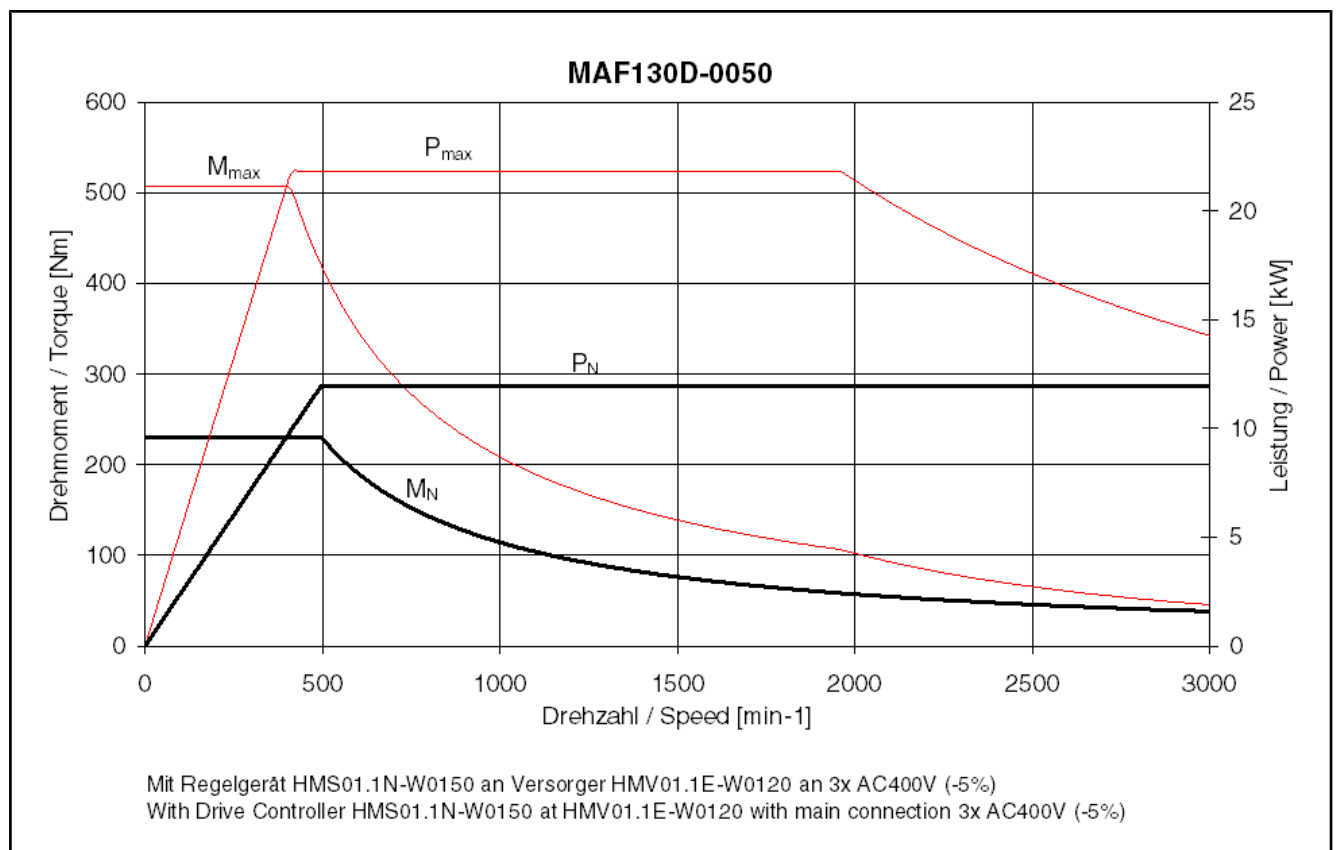

Fig.4-107: Motor characteristic curve of MAF130D-0050

Technical Data

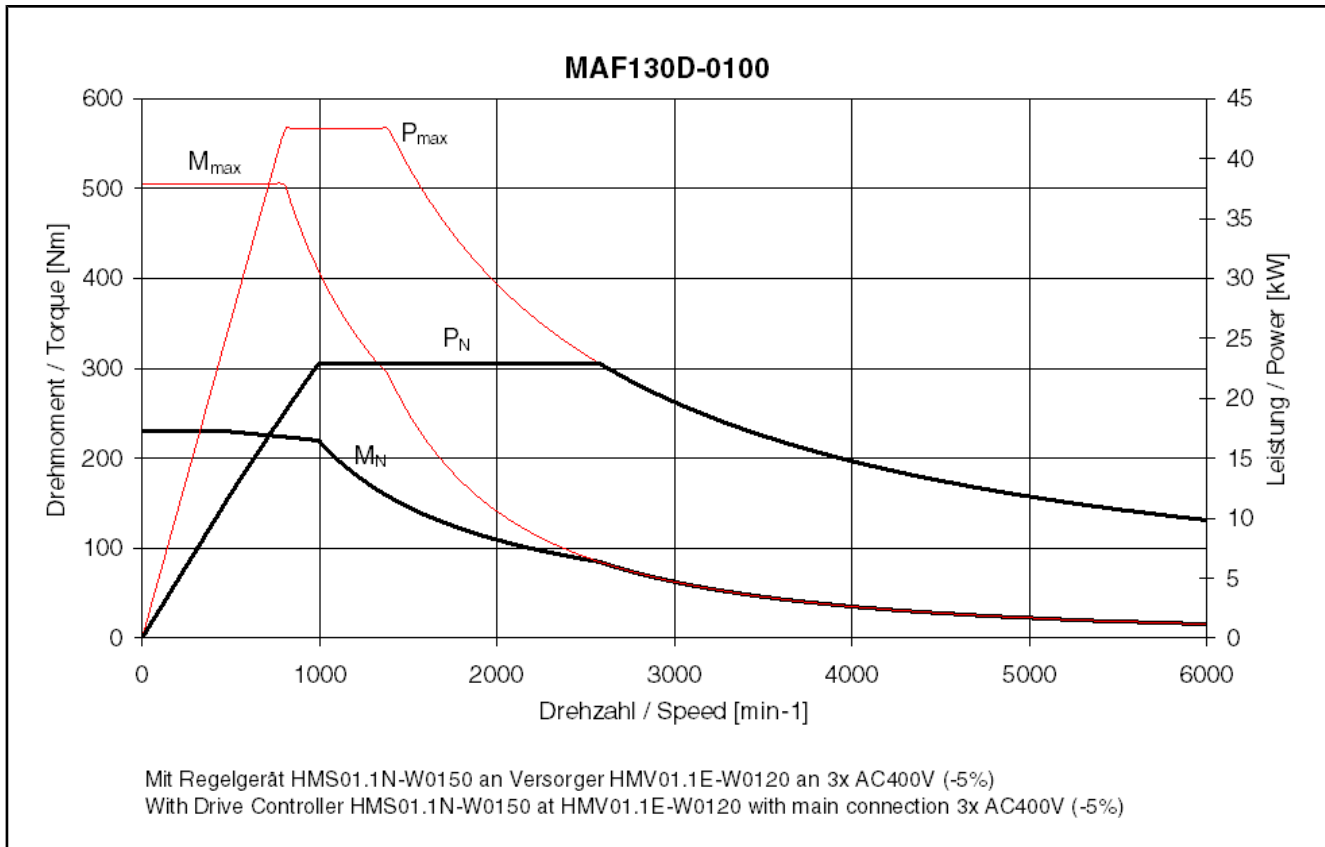

Fig.4-108: Motor characteristic curve of MAF130D-0100

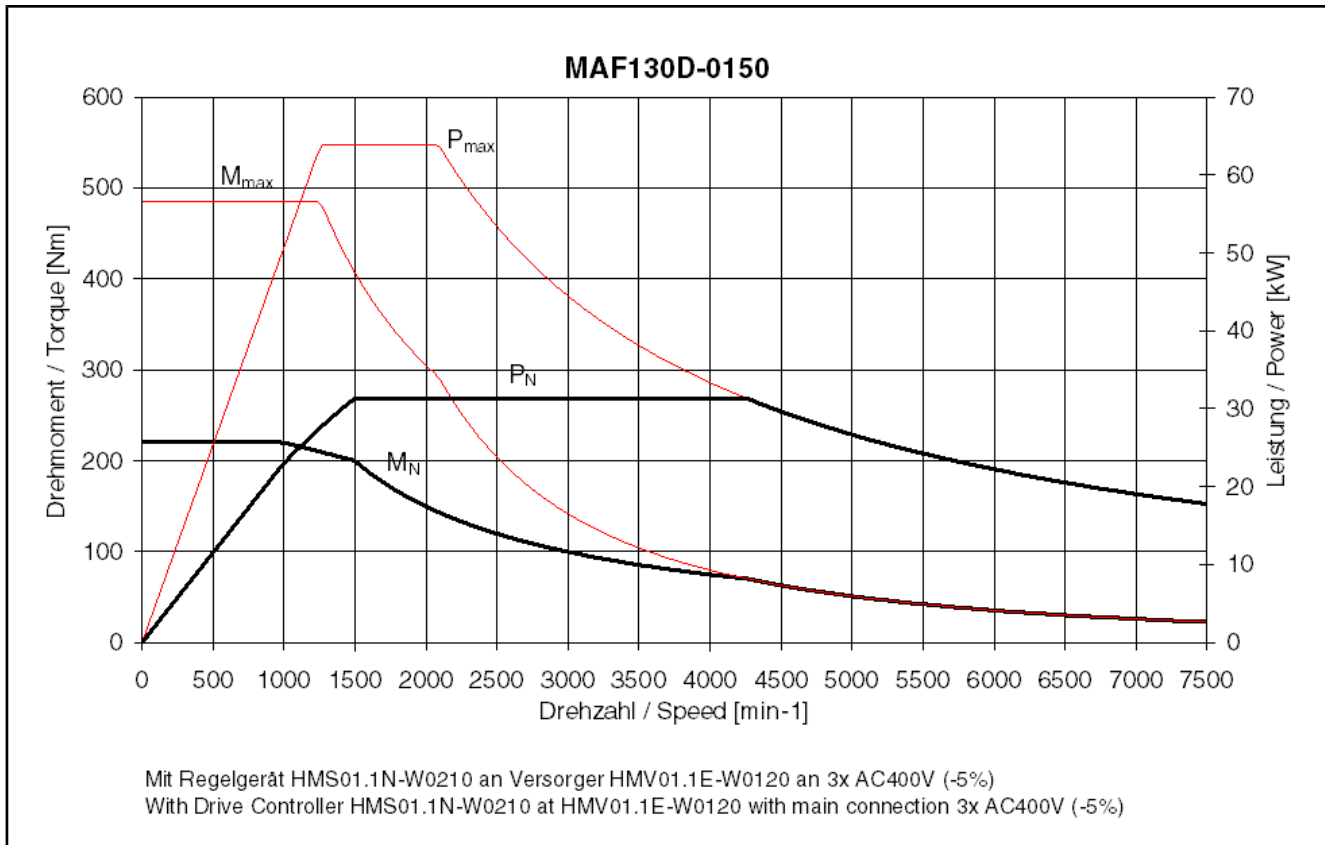

Fig.4-109: Motor characteristic curve of MAF130D-0150

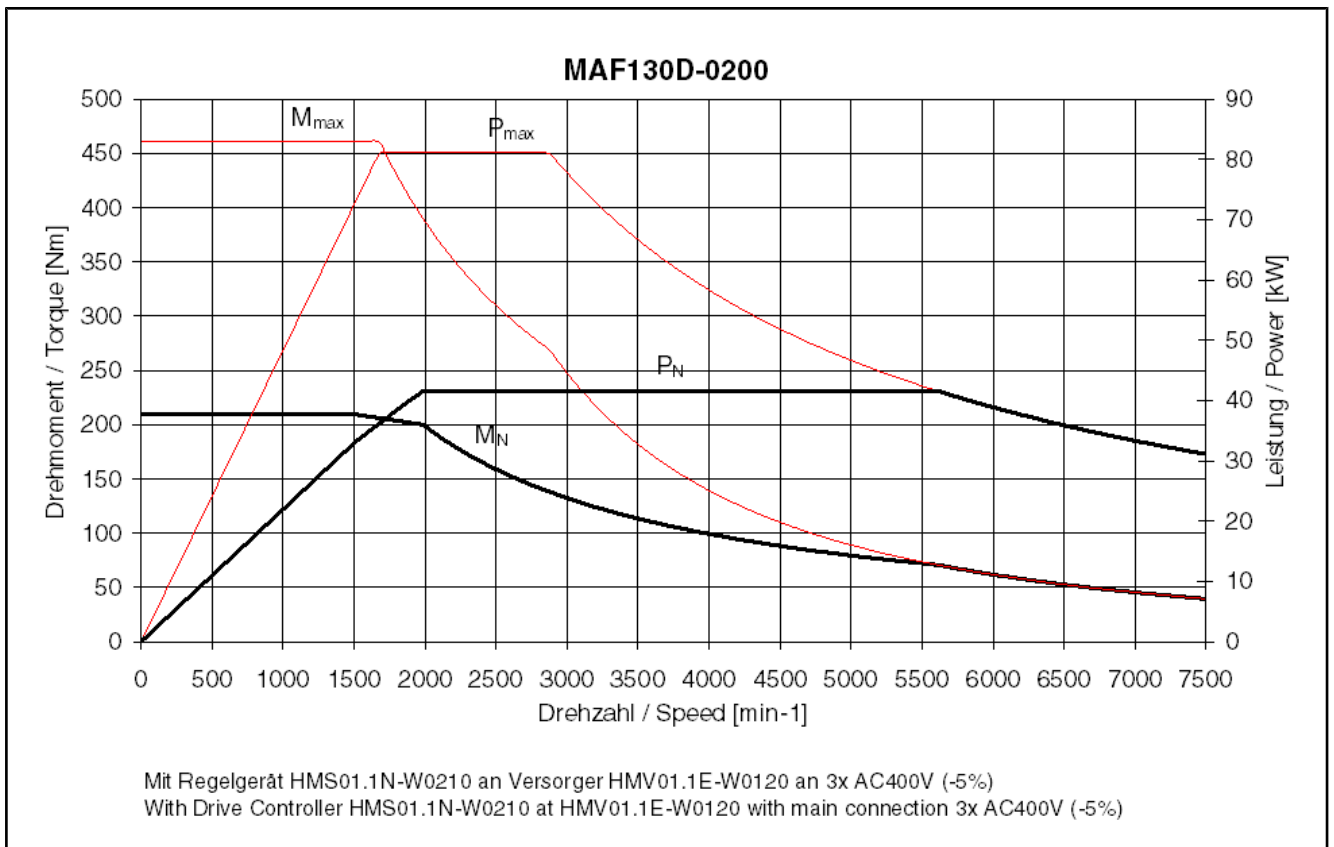

Fig.4-110: Motor characteristic curve of MAF130D-0200

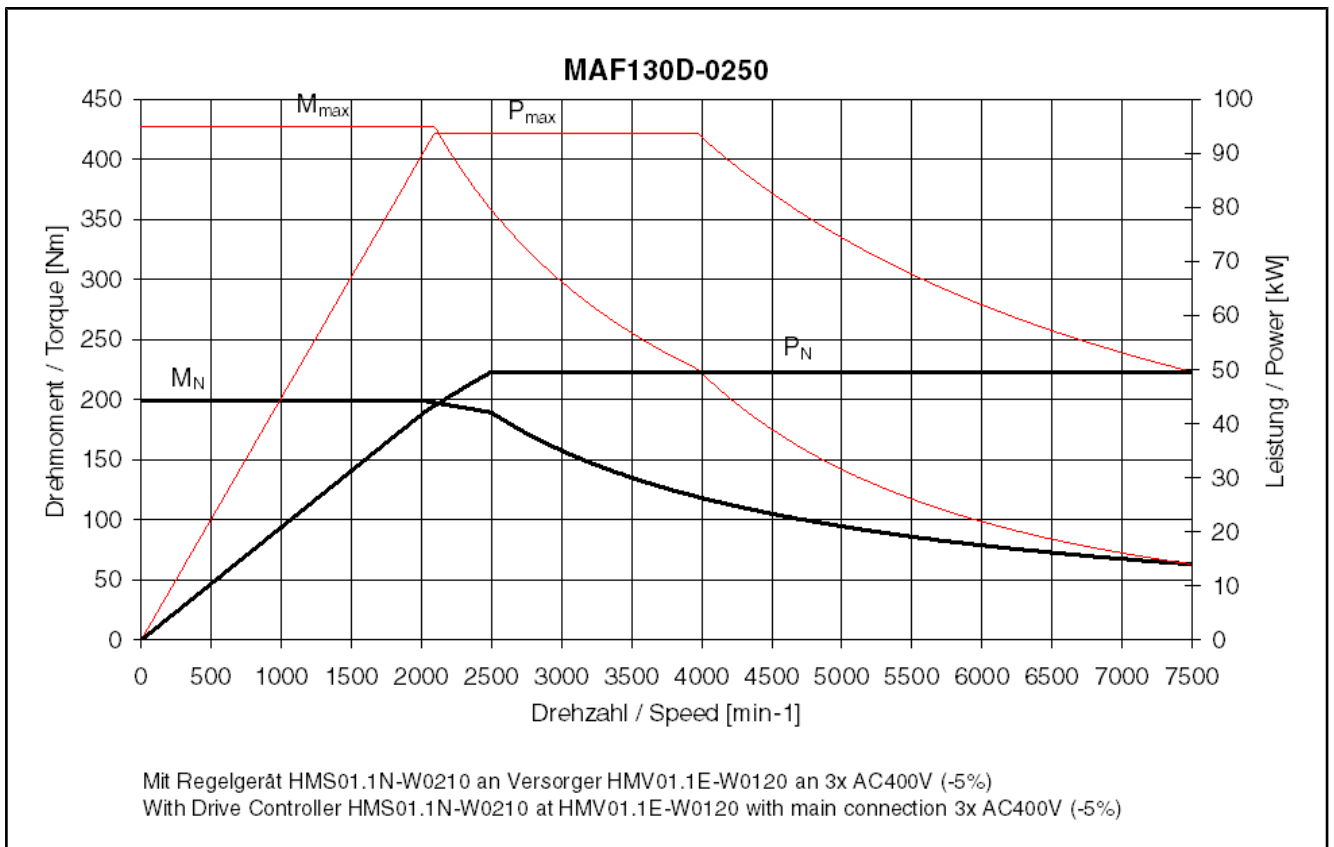

Fig.4-111: Motor characteristic curve of MAF130D-0250

Technical Data

4.9.7 Holding Brake MAD/MAF130 (Optional)

Data sheet - holding brake MAD/MAF130

Designation	Symbol	Unit	BRAKE 5	BRAKE 1
			Electrically clamping	Electrically releasing
Holding torque	M_4	Nm	100.0	80.0
Rated voltage	U_N	V	24	
Rated current	I_N	A	1.50	1.60
Holding brake moment of inertia	J_{br}	kg*m ²	0.003180	0.001710
Connection time	t_1	ms	110	50
Disconnection time	t_2	ms	65	140
Maximum holding brake speed	n_{Br_max}	min ⁻¹	8000	
Last revision: 2006-10-23				

Fig.4-112: Technical data of holding brake MAD/MAF130 (optional)

Technical Data

4.10 Technical Data of MAF160**4.10.1 Data Sheet of MAF160B**

Parameter	Symbol	Unit	MAF160B			
			0050	0100	0150	0200
Rated torque ¹⁾	M_N	Nm	270.0	260.0	250.0	240.0
Rated power	P_N	kW	14.10	27.20	39.30	50.30
Rated current	I_N	A	34.2	73.7	89.5	108.5
Rated speed	n_N	1/min	500	1,000	1,500	2,000
Key speed	n_1	1/min	500		1,000	1,500
Maximum torque	M_{max}	Nm	594.5	592.7	570.8	550.1
Maximum power	P_{S6max}	kW	28.91	55.76	80.57	103.12
Maximum current	$I_{max(eff)}$	A	65.4	149.0	179.7	232.7
Maximum speed with bearing A	n_{max}	1/min	3,000	6,000		
Maximum speed with bearing H	n_{max}	1/min	3,000	6,000	8,000	
Maximum speed with bearing N	n_{max}	1/min	3,000	6,000		
Maximum speed with bearing V	n_{max}	1/min	3,000	6,000		
Continuous torque at standstill	M_{n1}	Nm	270.0		260.0	250.0
Continuous current at standstill	I_{n1}	A	34.2	75.8	92.1	112.3
Torque constant at 20 °C	K_{M_N}	Nm/A	9.50	4.13	3.30	2.40
Thermal time constant	T_{th}	min	3.5			
Cycle duration (S6 - 44%)	T_C	min	5			
Discharge capacity of the component	C_{ab}	nF	26.9	35.0		21.7
Number of pole pairs	p	--	3			
Power wire cross-section	A	mm ²	6.0	25.0		35.0
Mass	m_{mot}	kg	197.0			
Rotor moment of inertia	J_{rot}	kg * m ²	0.2300000			
Sound pressure level	L_P	dB[A]	72 (+3)			
Ambient air temperature during operation	T_{um}	°C	0...+40			
Insulation class according to DIN EN 60034-1	I.CL.	-	155			
Data on liquid cooling						
Power loss to be dissipated	P_V	kW	3.10	4.00		4.50
Coolant supply temperature	T_{ein}	°C	10 ... 40			

Last revision: 2010-11-05

Technical Data

Parameter	Symbol	Unit	MAF160B			
			0050	0100	0150	0200
Allowed coolant temperature rise at P_V	ΔT_{max}	K	10			
Pressure drop at Q_{min}	Δp	bar	0.05	0.1		
Constant for determining the pressure drop with water as cooling medium	$K_{\Delta p}$	-	0.004			
Coolant flow required at P_V	Q_{min}	l/min	4.4	5.7		6.4
Coolant duct volume	V_{kuehl}	l	0.82			
Maximum allowed input pressure	p_{max}	bar	6.0			

Last revision: 2010-11-05

1) Please note the information on the specified parameters at the beginning of this chapter

Fig.4-113: Technical data of MAF160

4.10.2 Motor Characteristic Curves of MAF160B

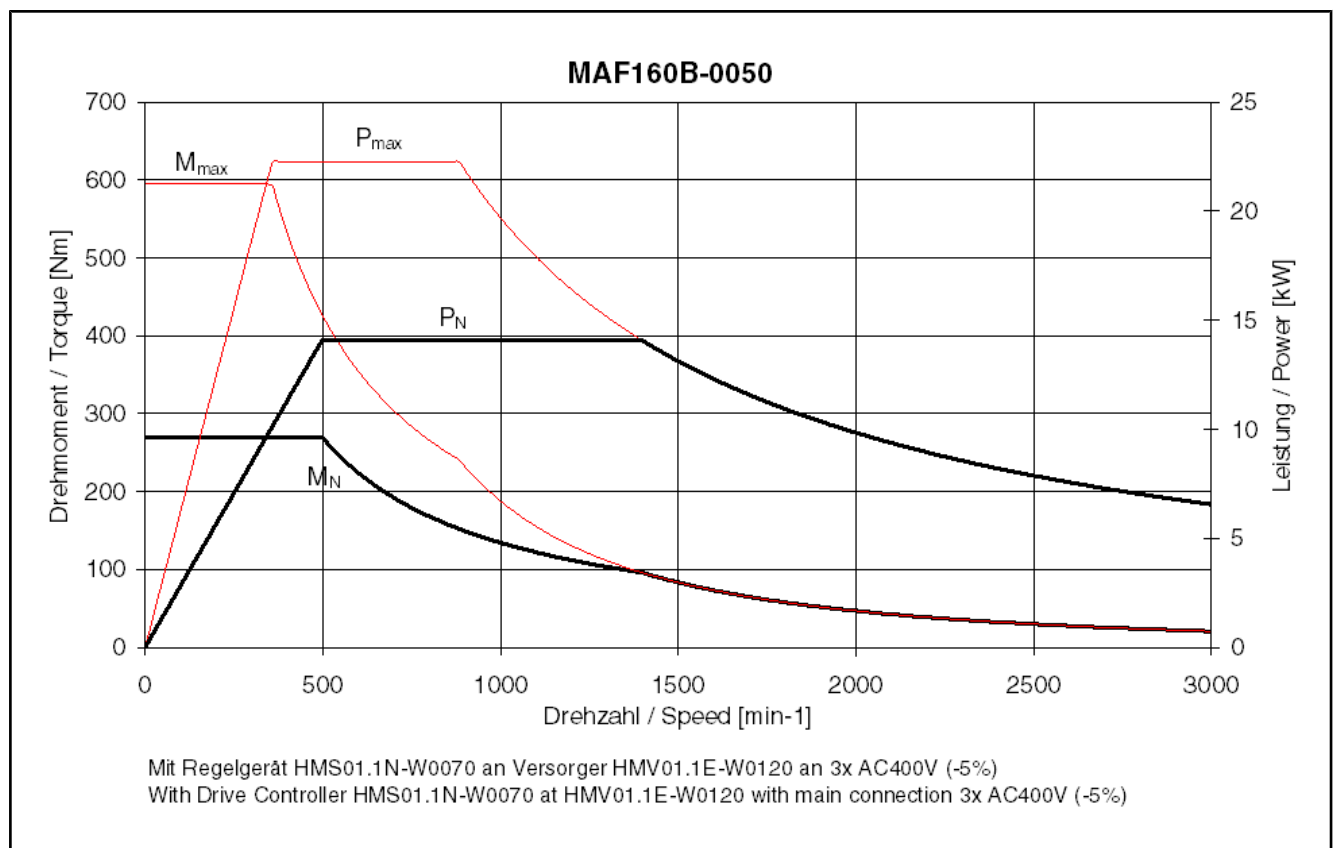

Fig.4-114: Motor characteristic curve of MAF160B-0050

Technical Data

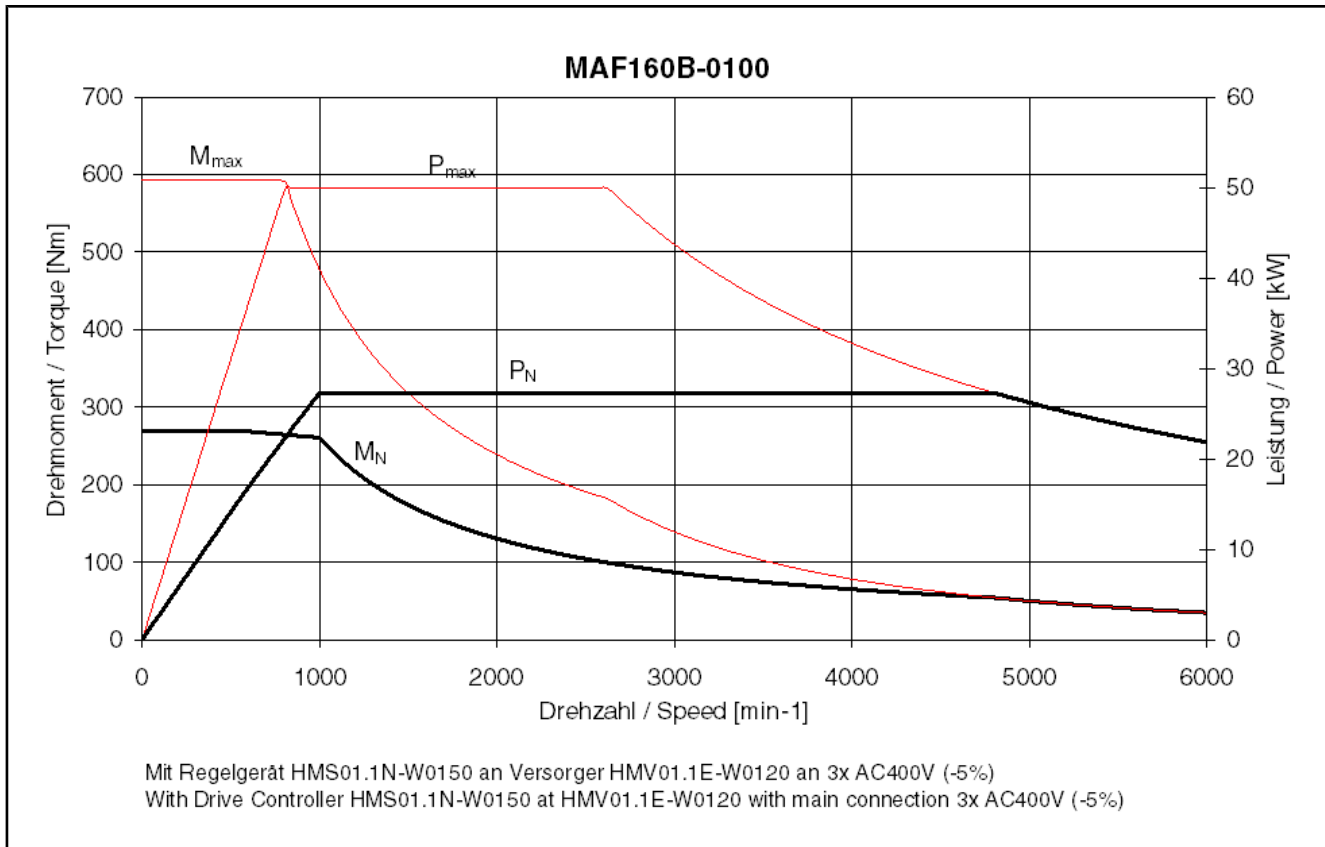

Fig.4-115: Motor characteristic curve of MAF160B-0100

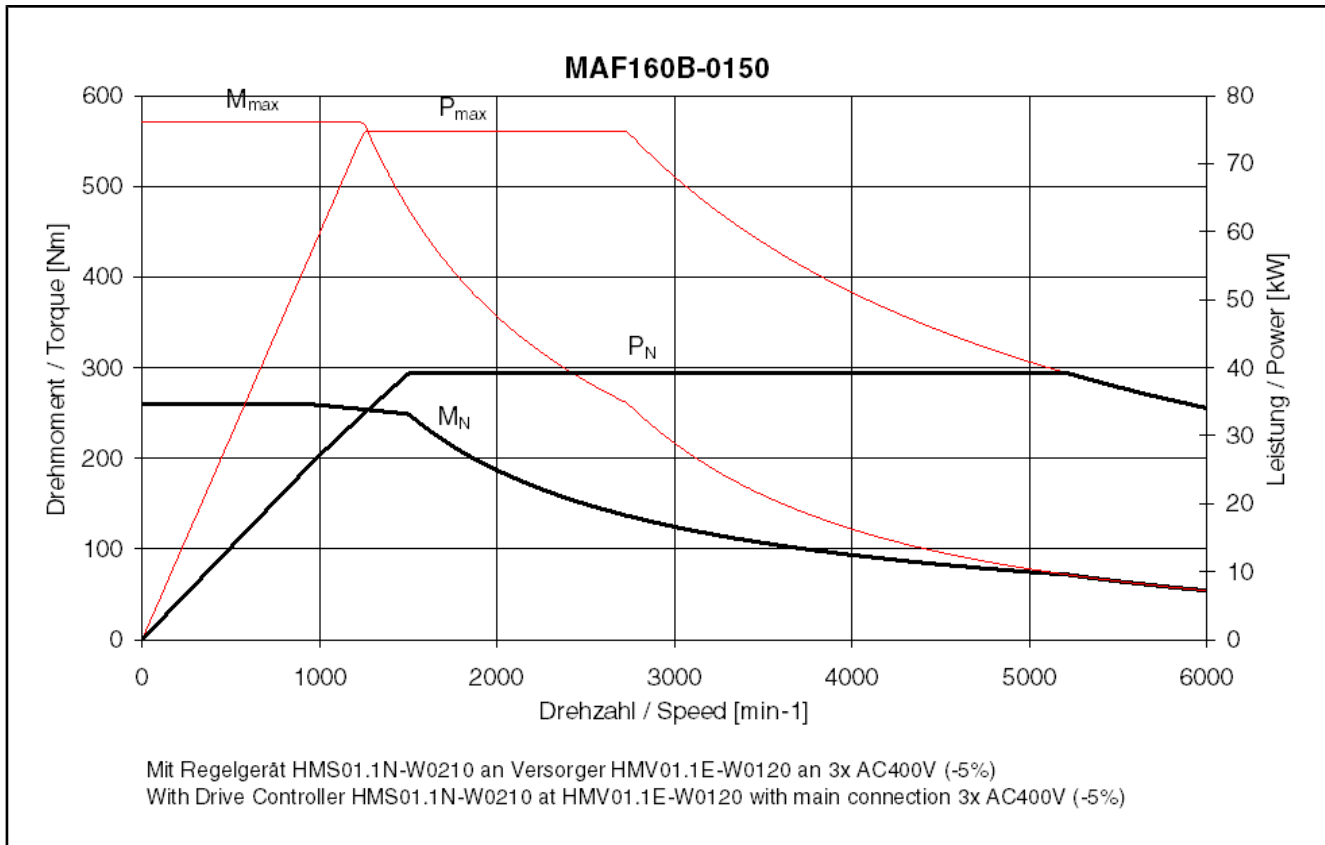

Fig.4-116: Motor characteristic curve of MAF160B-0150

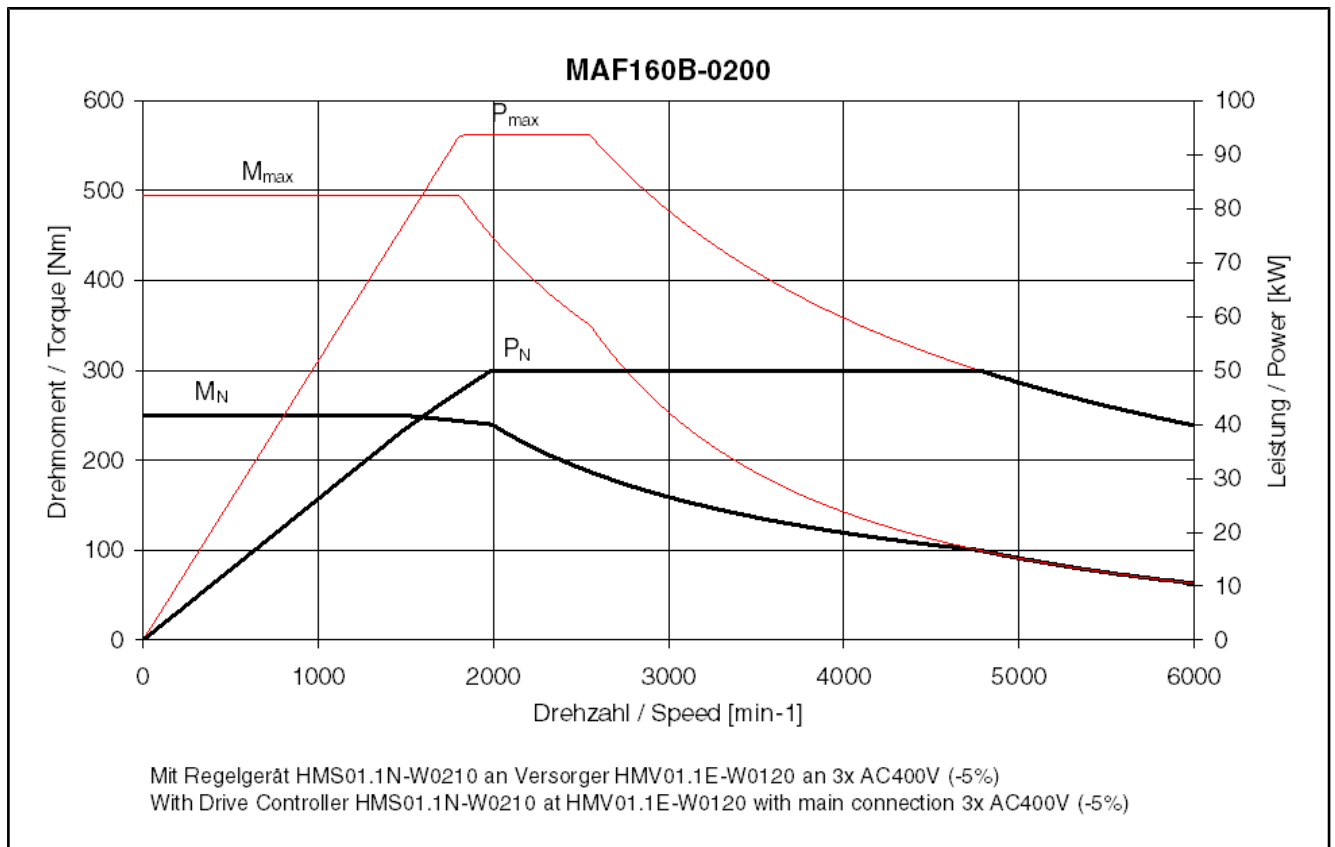

Fig.4-117: Motor characteristic curve of MAF160B-0200

Technical Data

4.10.3 Data Sheet of MAF160C

Parameter	Symbol	Unit	MAF160C			
			0050	0100	0150	0200
Rated torque ¹⁾	M_N	Nm	340.0	325.0	300.0	285.0
Rated power	P_N	kW	17.80	34.00	47.10	59.70
Rated current	I_N	A	47.4	91.2	109.5	136.0
Rated speed	n_N	1/min	500	1,000	1,500	2,000
Key speed	n_1	1/min	500		1,000	1,500
Maximum torque	M_{max}	Nm	747.8	746.4	681.4	677.4
Maximum power	P_{S6max}	kW	36.49	69.70	96.56	122.39
Maximum current	$I_{max(eff)}$	A	98.0	196.0	212.2	290.7
Maximum speed with bearing A	n_{max}	1/min	3,000	6,000		
Maximum speed with bearing H	n_{max}	1/min	3,000	6,000	8,000	
Maximum speed with bearing N	n_{max}	1/min	3,000	6,000		
Maximum speed with bearing V	n_{max}	1/min	3,000	6,000		
Continuous torque at standstill	M_{n1}	Nm	340.0		310.0	295.0
Continuous current at standstill	I_{n1}	A	47.4	94.8	111.9	141.4
Torque constant at 20 °C	K_{M-N}	Nm/A	7.76	3.88	3.37	2.30
Thermal time constant	T_{th}	min	3.5			
Cycle duration (S6 - 44%)	T_C	min	5			
Discharge capacity of the component	C_{ab}	nF	28.0		28.8	25.3
Number of pole pairs	p	--	3			
Power wire cross-section	A	mm ²	10.0	25.0	35.0	2 x 25.0
Mass	m_{mot}	kg	227.0			
Rotor moment of inertia	J_{rot}	kg * m ²	0.2600000			
Sound pressure level	L_P	dB[A]	72 (+3)			
Ambient air temperature during operation	T_{um}	°C	0...+40			
Insulation class according to DIN EN 60034-1	I.CL.	-	155			
Data on liquid cooling						
Power loss to be dissipated	P_V	kW	3.50	3.70	3.76	4.20
Coolant supply temperature	T_{ein}	°C	10 ... 40			

Last revision: 2010-11-05

Technical Data

Parameter	Symbol	Unit	MAF160C			
			0050	0100	0150	0200
Allowed coolant temperature rise at P_V	ΔT_{max}	K	10			
Pressure drop at Q_{min}	Δp	bar	0.1			
Constant for determining the pressure drop with water as cooling medium	$K_{\Delta p}$	-	0.01		0.004	
Coolant flow required at P_V	Q_{min}	l/min	5.0	5.3	5.4	6.0
Coolant duct volume	V_{kuehl}	l	0.99			
Maximum allowed input pressure	p_{max}	bar	6.0			

Last revision: 2010-11-05

1) Please note the information on the specified parameters at the beginning of this chapter

Fig.4-118: Technical data of MAF160C

4.10.4 Motor Characteristic Curves of MAF160C

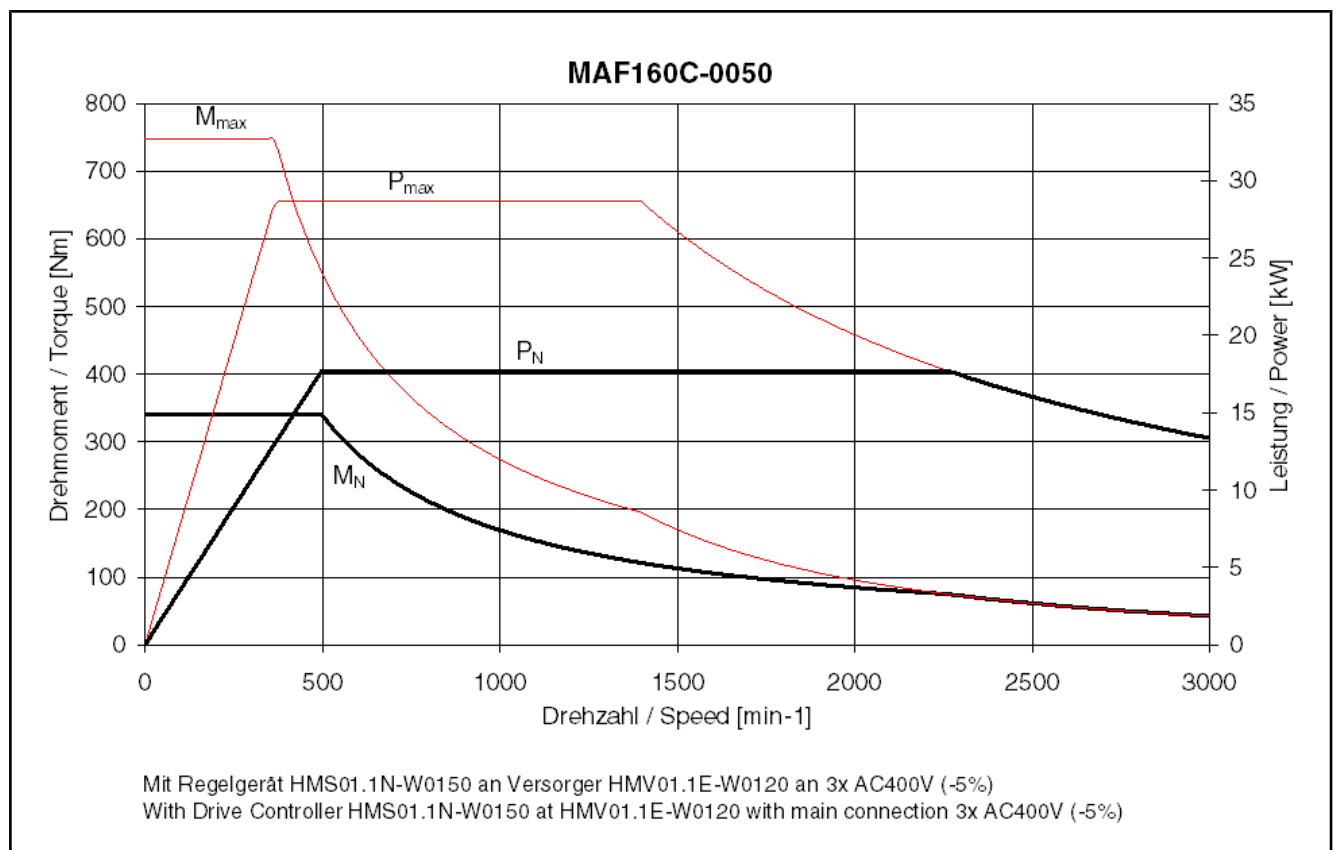

Fig.4-119: Motor characteristic curve of MAF160C-0050

Technical Data

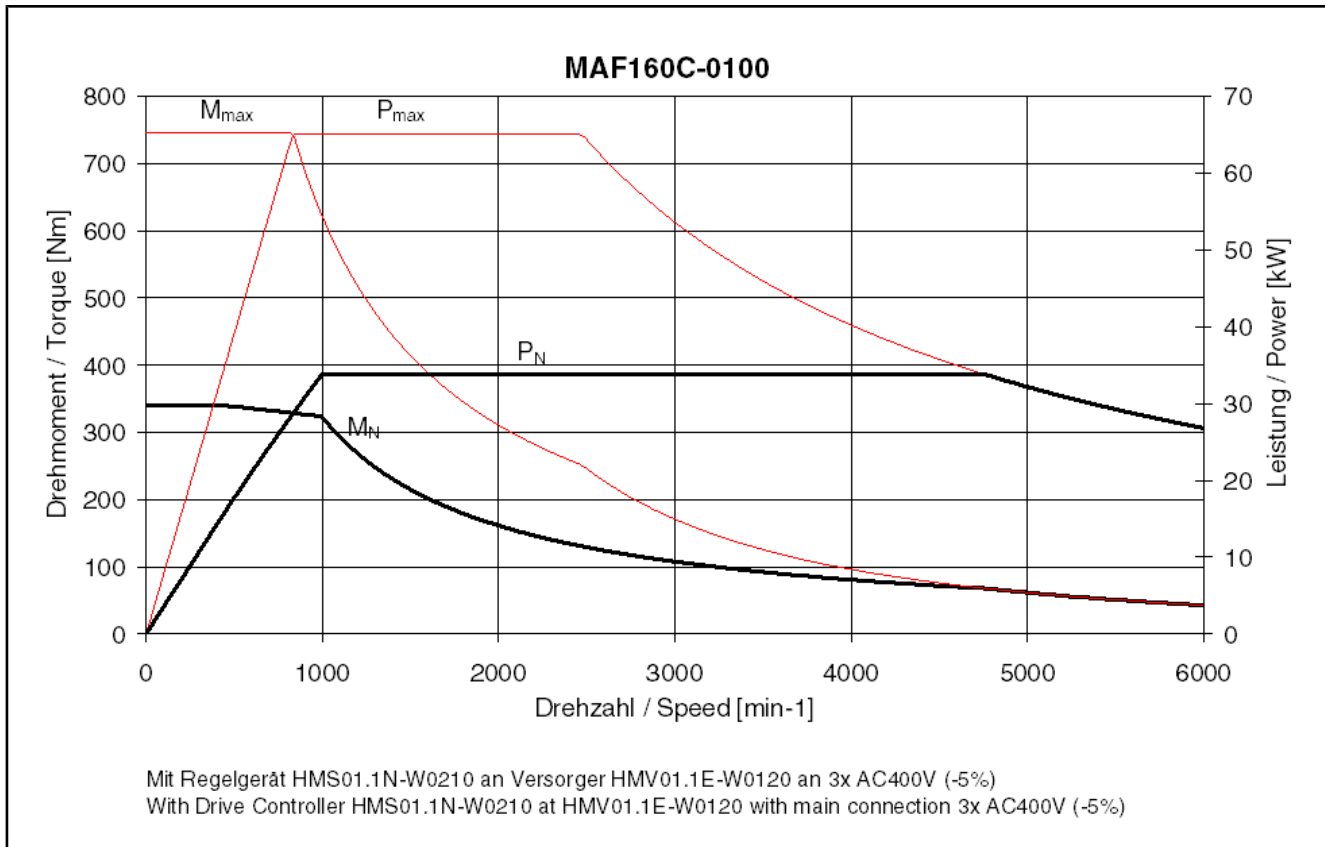

Fig.4-120: Motor characteristic curve of MAF160C-0100

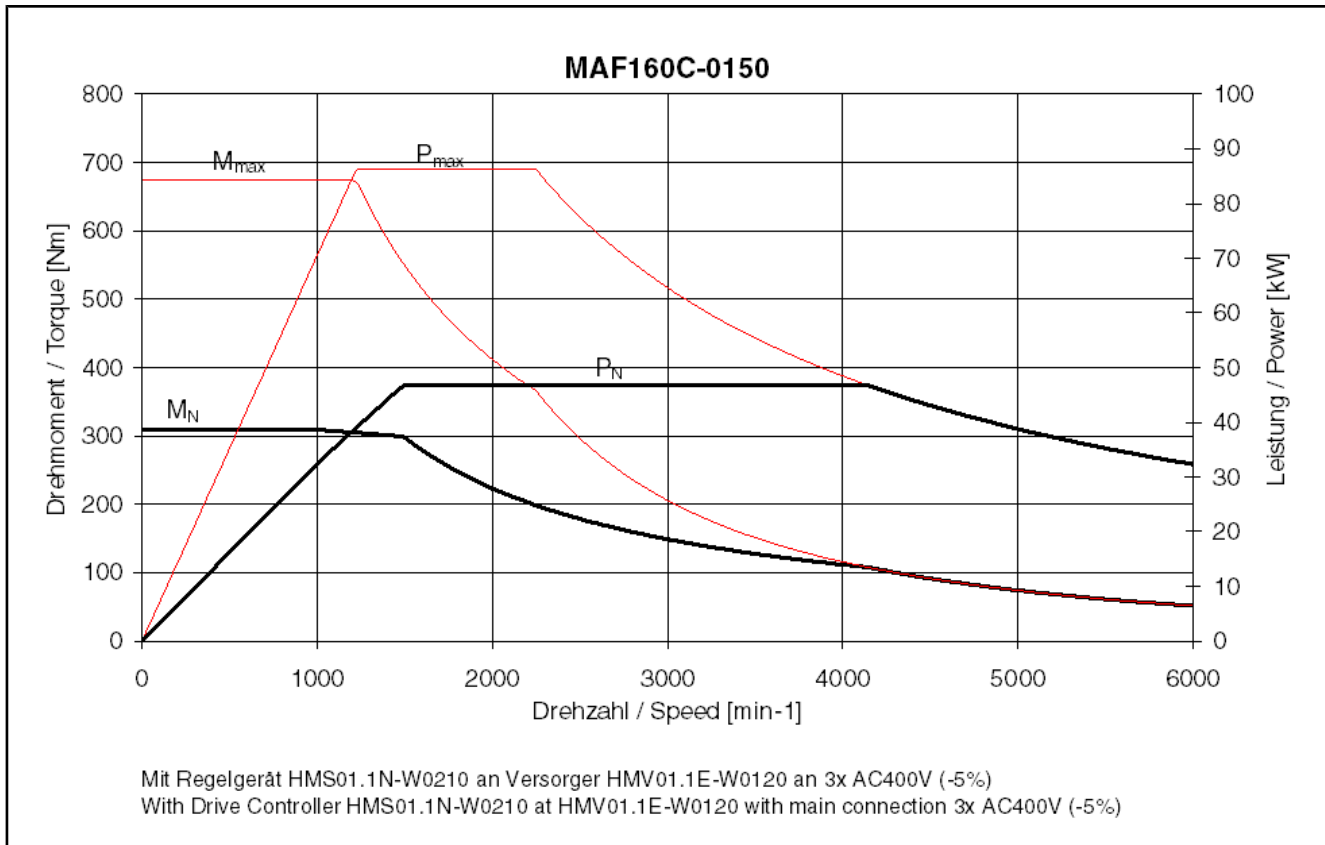

Fig.4-121: Motor characteristic curve of MAF160C-0150

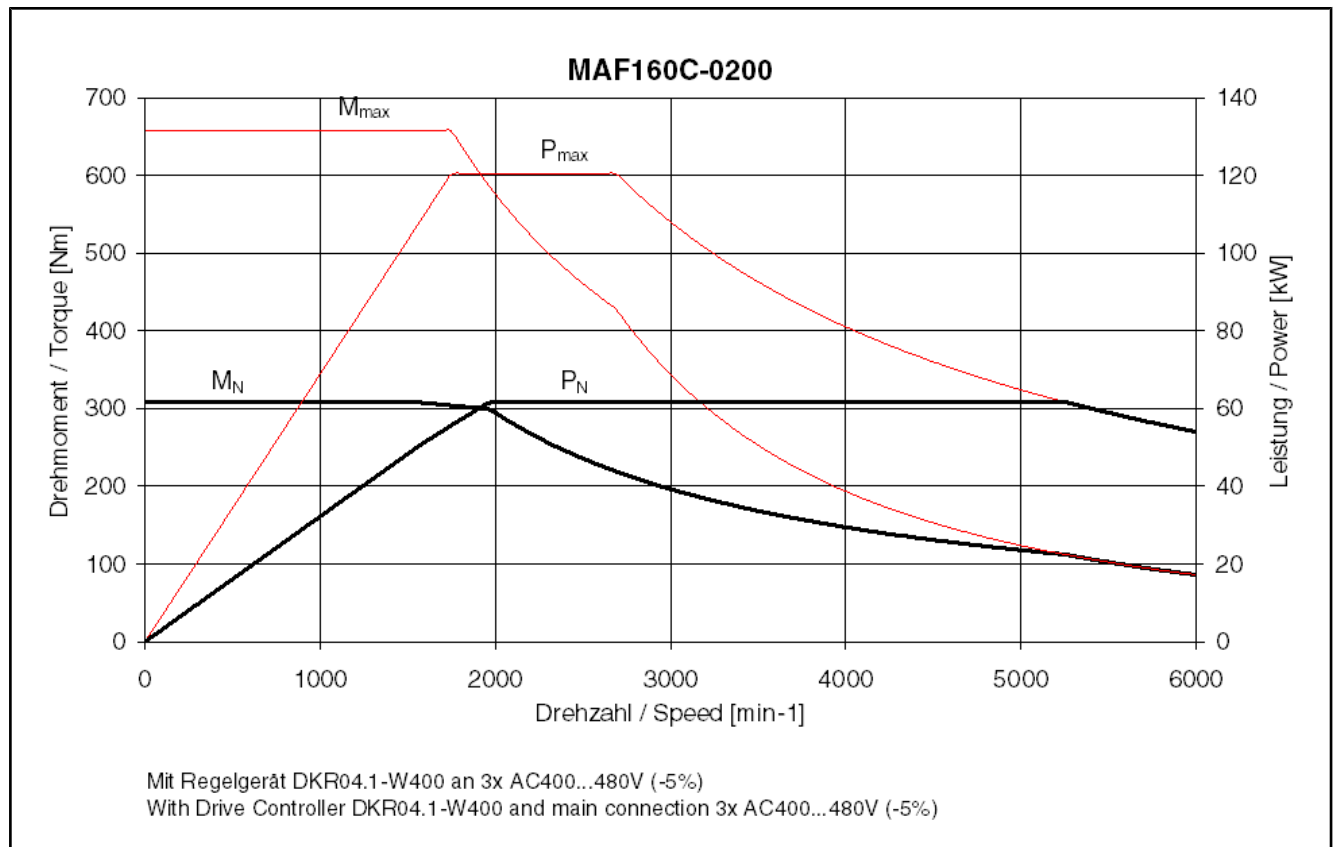

Fig.4-122: Motor characteristic curve of MAF160C-0200

4.10.5 Holding Brake MAD/MAF160 (Optional)

Data sheet - holding brake MAD/MAF160

Designation	Symbol	Unit	BRAKE 5 Electrically clamping	BRAKE 3 (MAD only) Electrically releasing, reinforced design	BRAKE 1 Electrically releasing
Holding torque	M_4	Nm	100.0	240.0	100.0
Rated voltage	U_N	V	24		
Rated current	I_N	A	1.80	1.87	2.00
Holding brake moment of inertia	J_{br}	kg*m ²	0.005010	0.018800	0.005300
Connection time	t_1	ms	85	130	70
Disconnection time	t_2	ms	100	300	190
Maximum holding brake speed	n_{Br_max}	min ⁻¹	8,000	6,000	8,000

Last revision: 2006-10-23

Fig.4-123: Technical data of holding brake MAD/MAF160 (optional)

Technical Data

4.11 Technical Data of MAF180**4.11.1 Data Sheet of MAF180C**

Parameter	Symbol	Unit	MAF180C			
			0050	0100	0150	0200
Rated torque ¹⁾	M_N	Nm	435.0	400.0	365.0	318.0
Rated power	P_N	kW	22.80	41.90	57.33	66.60
Rated current	I_N	A	50.0	93.5	128.8	154.0
Rated speed	n_N	1/min	500	1,000	1,500	2,000
Key speed	n_1	1/min	500		1,000	1,500
Maximum torque	M_{max}	Nm	986.2	957.0	858.1	739.2
Maximum power	P_{S6max}	kW	46.74	82.00	117.53	136.53
Maximum current	$I_{max(eff)}$	A	104.7	215.0	280.9	318.9
Maximum speed with bearing A	n_{max}	1/min	3,000	6,000		
Maximum speed with bearing N	n_{max}	1/min	3,000	6,000		
Maximum speed with bearing V	n_{max}	1/min	3,000	6,000		
Continuous torque at standstill	M_{n1}	Nm	435.0		390.0	336.0
Continuous current at standstill	I_{n1}	A	51.2	97.6	136.1	160.5
Torque constant at 20 °C	$K_{M,N}$	Nm/A	9.61	5.04	3.11	2.39
Thermal time constant	T_{th}	min	3.5			
Cycle duration (S6 - 44%)	T_C	min	5			
Discharge capacity of the component	C_{ab}	nF	32.5	35.9	30.0	38.9
Number of pole pairs	p	--	3			
Power wire cross-section	A	mm ²	10.0	25.0	2 x 25.0	2 x 35.0
Mass	m_{mot}	kg	322.0			
Rotor moment of inertia	J_{rot}	kg * m ²	0.4900000			
Sound pressure level	L_P	dB[A]	75 (+3)			
Ambient air temperature during operation	T_{um}	°C	0...+40			
Insulation class according to DIN EN 60034-1	I.CL.	-	155			
Data on liquid cooling						
Power loss to be dissipated	P_V	kW	3.90	4.00	4.50	
Coolant supply temperature	T_{ein}	°C	10 ... 40			

Last revision: 2010-11-05

Technical Data

Parameter	Symbol	Unit	MAF180C			
			0050	0100	0150	0200
Allowed coolant temperature rise at P_V	ΔT_{max}	K	10			
Pressure drop at Q_{min}	Δp	bar	0.1		0.2	
Constant for determining the pressure drop with water as cooling medium	$K_{\Delta p}$	-	0.01			
Coolant flow required at P_V	Q_{min}	l/min	5.6	5.7	6.4	
Coolant duct volume	V_{kuehl}	l	1.25			
Maximum allowed input pressure	p_{max}	bar	6.0			

Last revision: 2010-11-05

1) Please note the information on the specified parameters at the beginning of this chapter

Fig.4-124: MAF180C - Technical data

4.11.2 Motor Characteristic Curves of MAF180C

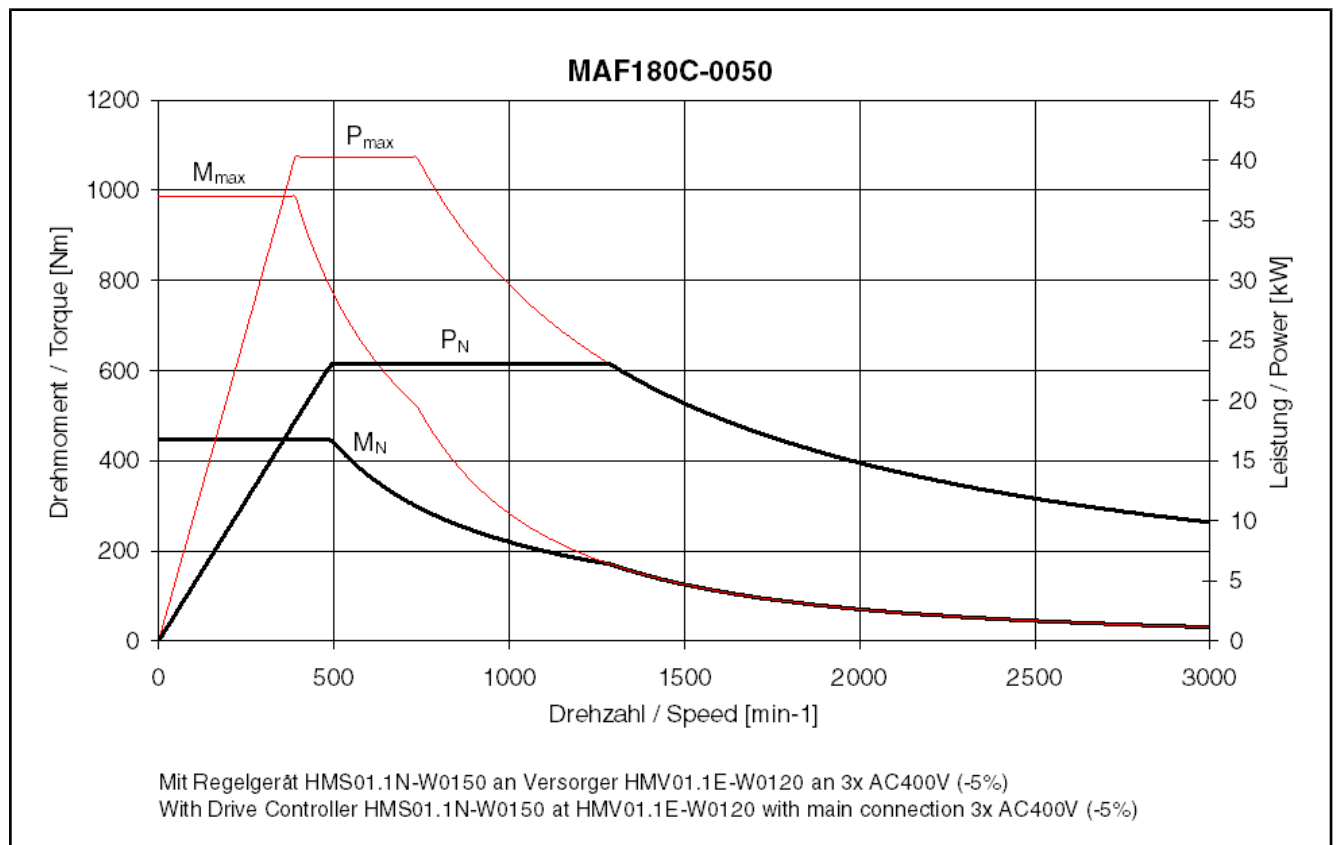

Fig.4-125: Motor characteristic curve of MAF180C-0050

Technical Data

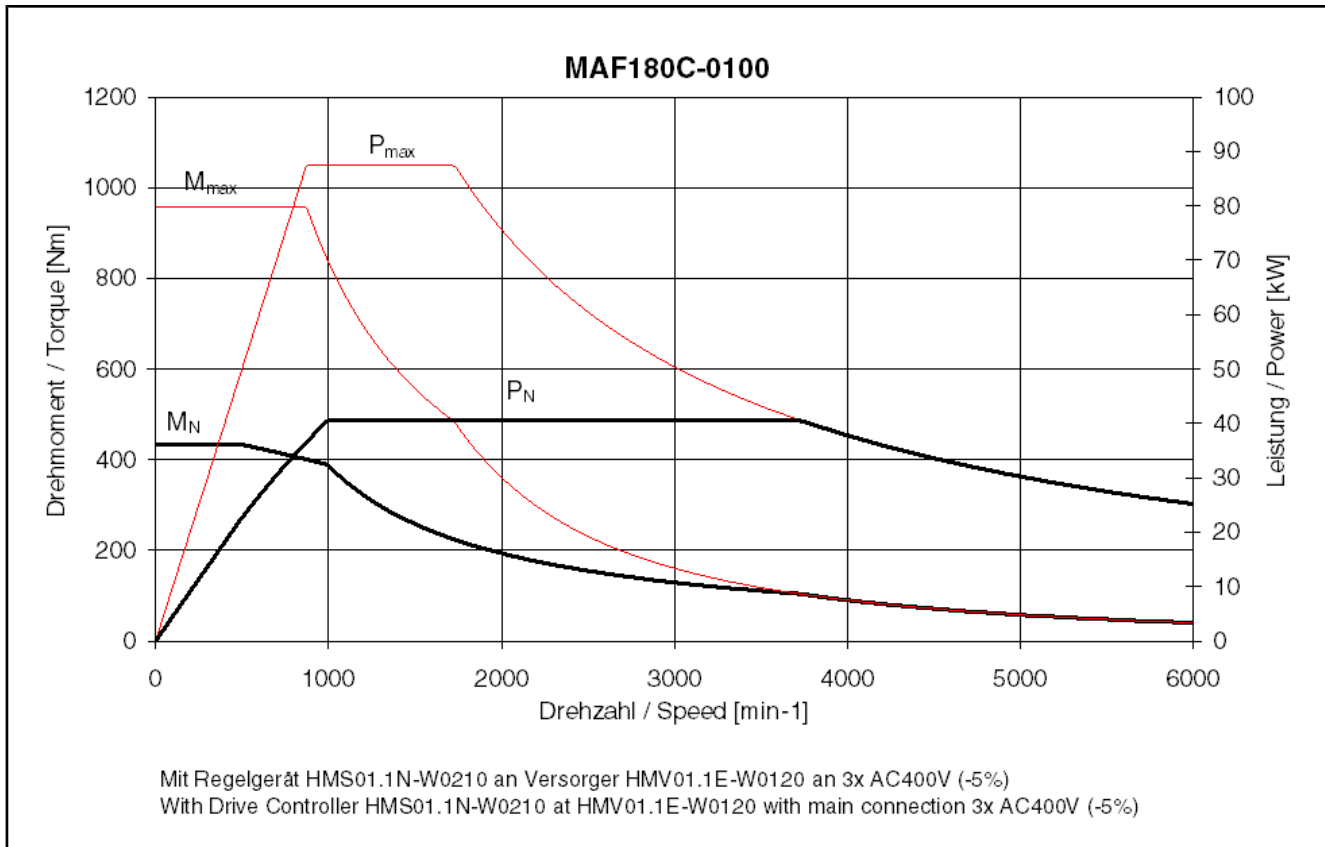

Fig.4-126: Motor characteristic curve of MAF180C-0100

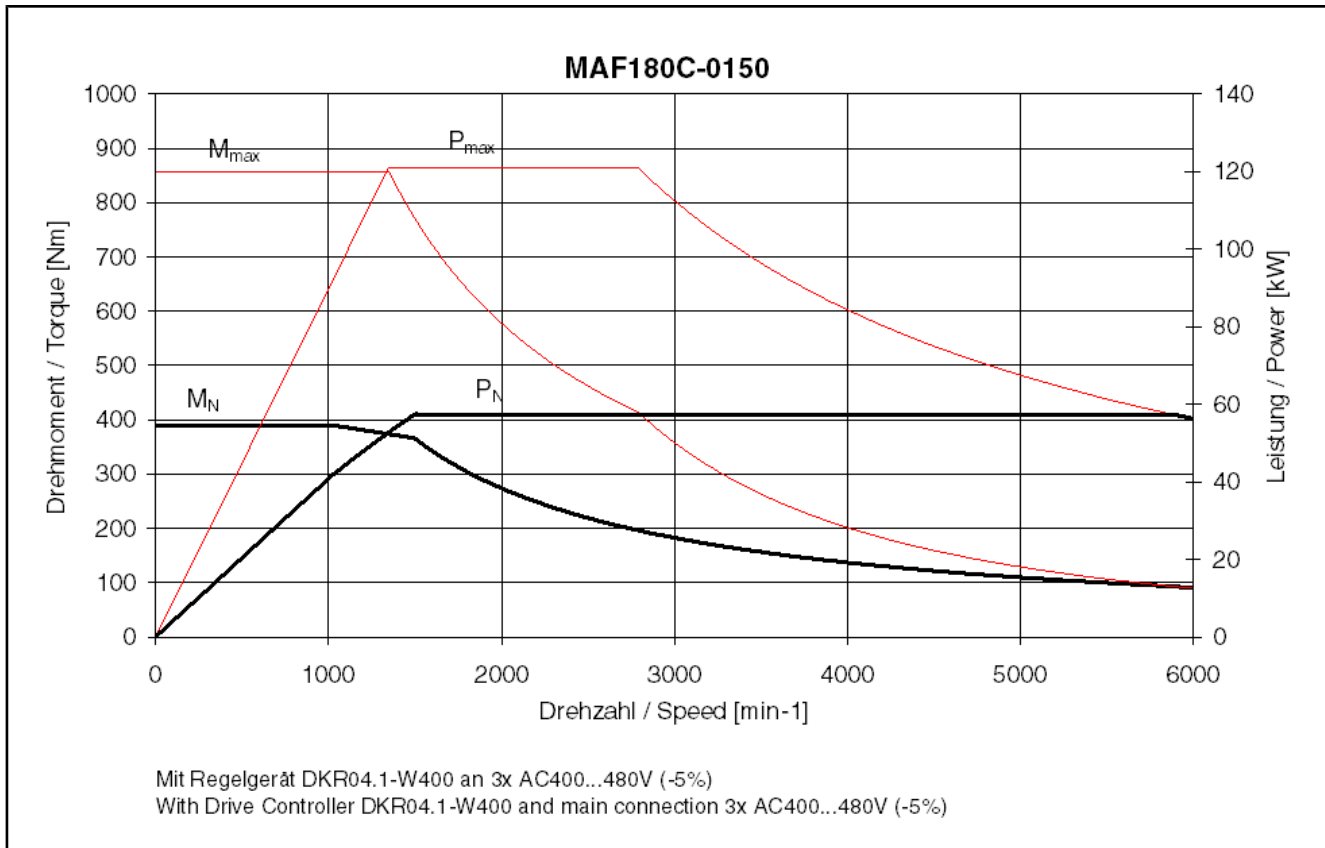

Fig.4-127: Motor characteristic curve of MAF180C-0150

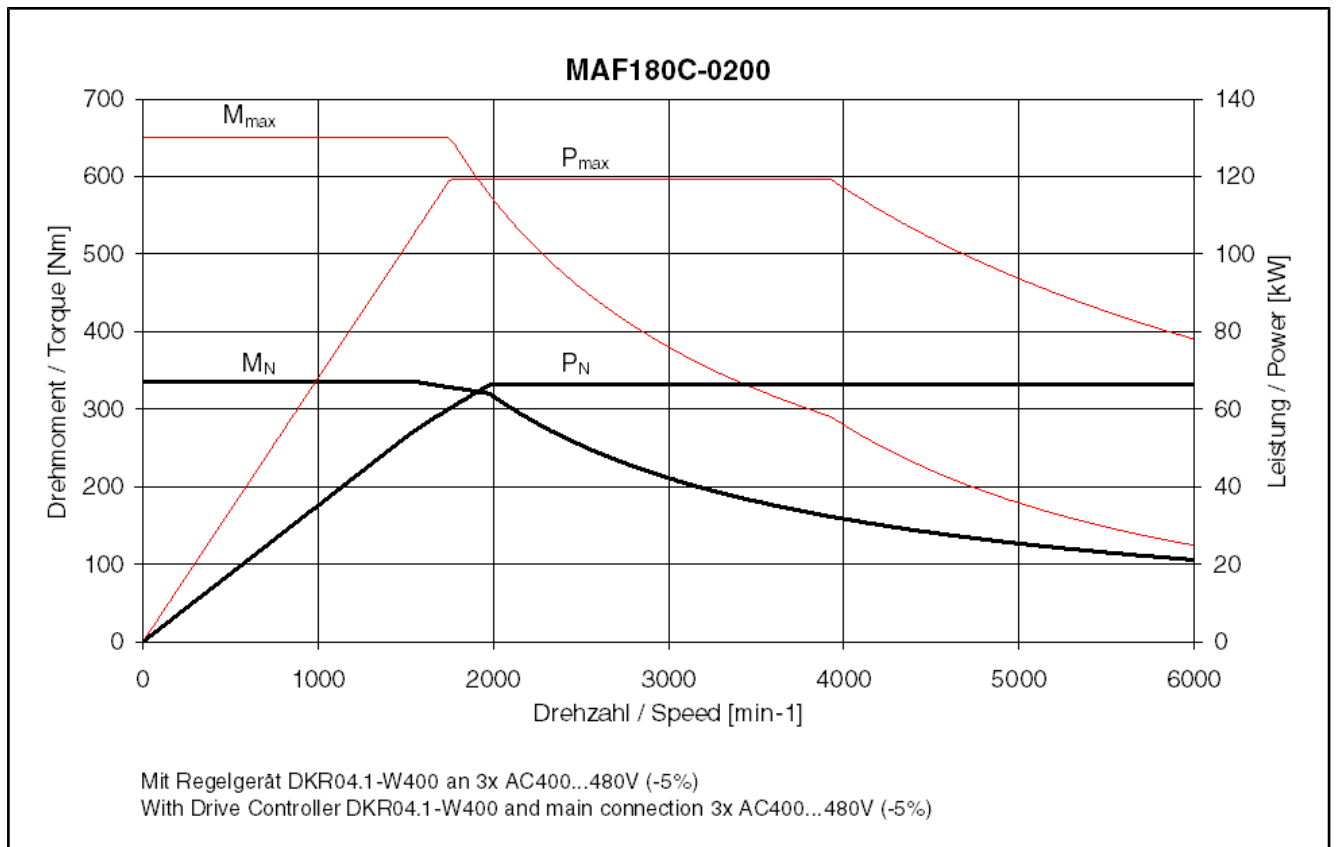

Fig.4-128: Motor characteristic curve of MAF180C-0200

Technical Data

4.11.3 Data Sheet of MAF180D

Parameter	Symbol	Unit	MAF180D			
			0050	0100	0150	0200
Rated torque ¹⁾	M_N	Nm	500.0		435.0	400.0
Rated power	P_N	kW	26.20	52.36	68.33	83.80
Rated current	I_N	A	60.4	106.5	146.1	168.5
Rated speed	n_N	1/min	500	1,000	1,500	2,000
Key speed	n_1	1/min	500		1,000	1,500
Maximum torque	M_{max}	Nm	1,100.2	1,100.0	1,013.0	1,008.0
Maximum power	P_{S6max}	kW	53.71	120.00	140.08	171.79
Maximum current	$I_{max(eff)}$	A	117.3	208.2	296.2	377.1
Maximum speed with bearing A	n_{max}	1/min	3,000	6,000		
Maximum speed with bearing N	n_{max}	1/min	3,000	6,000		
Maximum speed with bearing V	n_{max}	1/min	3,000	6,000		
Continuous torque at standstill	M_{n1}	Nm	500.0	525.0	460.0	
Continuous current at standstill	I_{n1}	A	60.4	109.5	146.1	187.3
Torque constant at 20 °C	$K_{M,N}$	Nm/A	10.00	4.98	3.31	2.75
Thermal time constant	T_{th}	min	9.1			
Cycle duration (S6 - 44%)	T_C	min	5	1	5	
Discharge capacity of the component	C_{ab}	nF	37.4	34.1	30.3	50.0
Number of pole pairs	p	--	3			
Power wire cross-section	A	mm ²	16.0	35.0	2 x 25.0	2 x 35.0
Mass	m_{mot}	kg	382.0			
Rotor moment of inertia	J_{rot}	kg * m ²	0.6100000			
Sound pressure level	L_P	dB[A]	75 (+3)			
Ambient air temperature during operation	T_{um}	°C	0...+40			
Insulation class according to DIN EN 60034-1	I.CL.	-	155			
Data on liquid cooling						
Power loss to be dissipated	P_V	kW	3.50	4.39	3.62	5.40
Coolant supply temperature	T_{ein}	°C	10 ... 40			
Allowed coolant temperature rise at P_V	ΔT_{max}	K	10			

Last revision: 2010-11-05

Parameter	Symbol	Unit	MAF180D			
			0050	0100	0150	0200
Pressure drop at Q_{min}	Δp	bar	0.1	0.5	0.1	0.2
Constant for determining the pressure drop with water as cooling medium	$K_{\Delta p}$	-	0.01	0.02	0.01	
Coolant flow required at P_V	Q_{min}	l/min	5.0	6.3	5.2	7.7
Coolant duct volume	V_{kuehl}	l	1.45			
Maximum allowed input pressure	p_{max}	bar	6.0			

Last revision: 2010-11-05

1) Please note the information on the specified parameters at the beginning of this chapter

Fig.4-129: MAF180D - Technical data

4.11.4 Motor Characteristic Curves of MAF180D

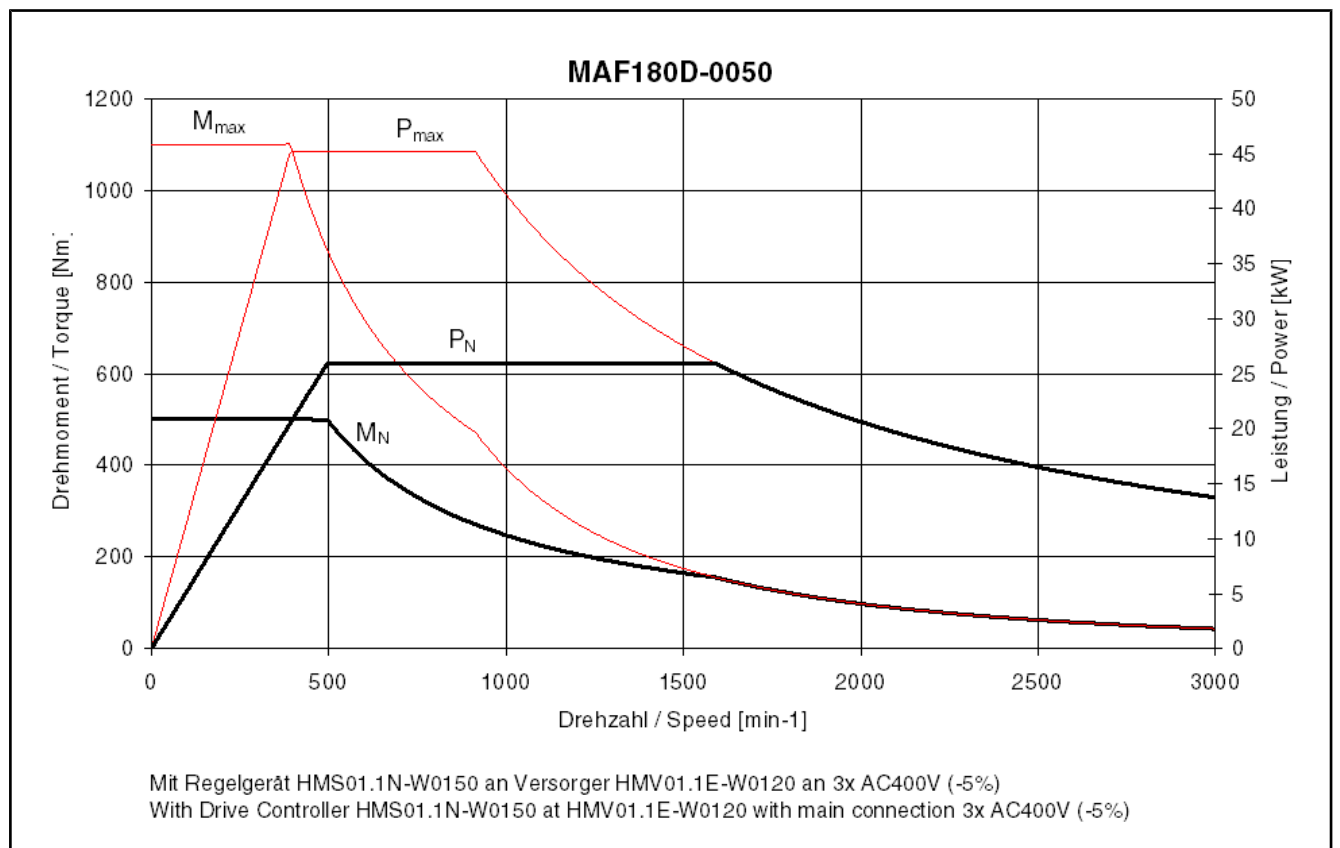

Fig.4-130: Motor characteristic curve of MAF180D-0050

Technical Data

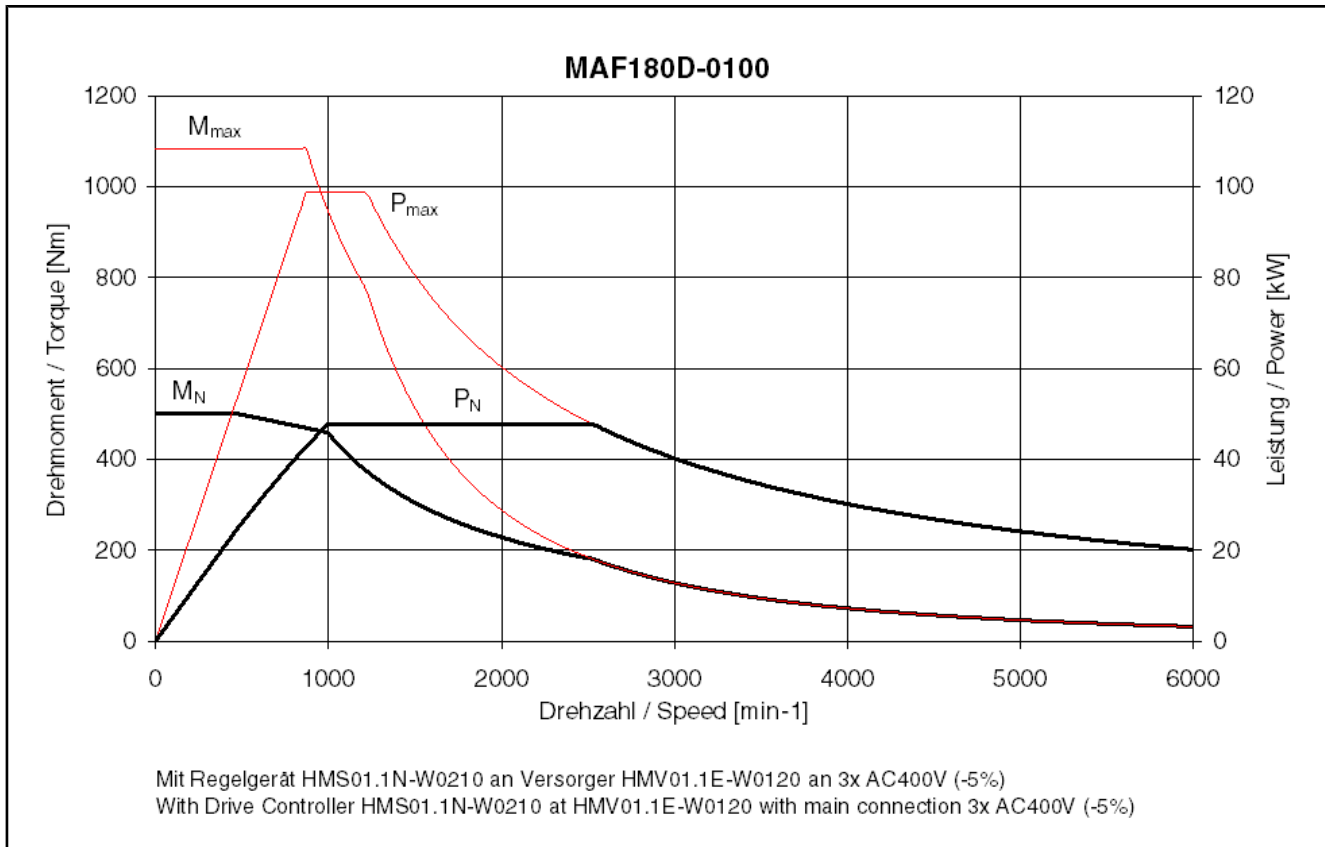

Fig.4-131: Motor characteristic curve of MAF180D-0100

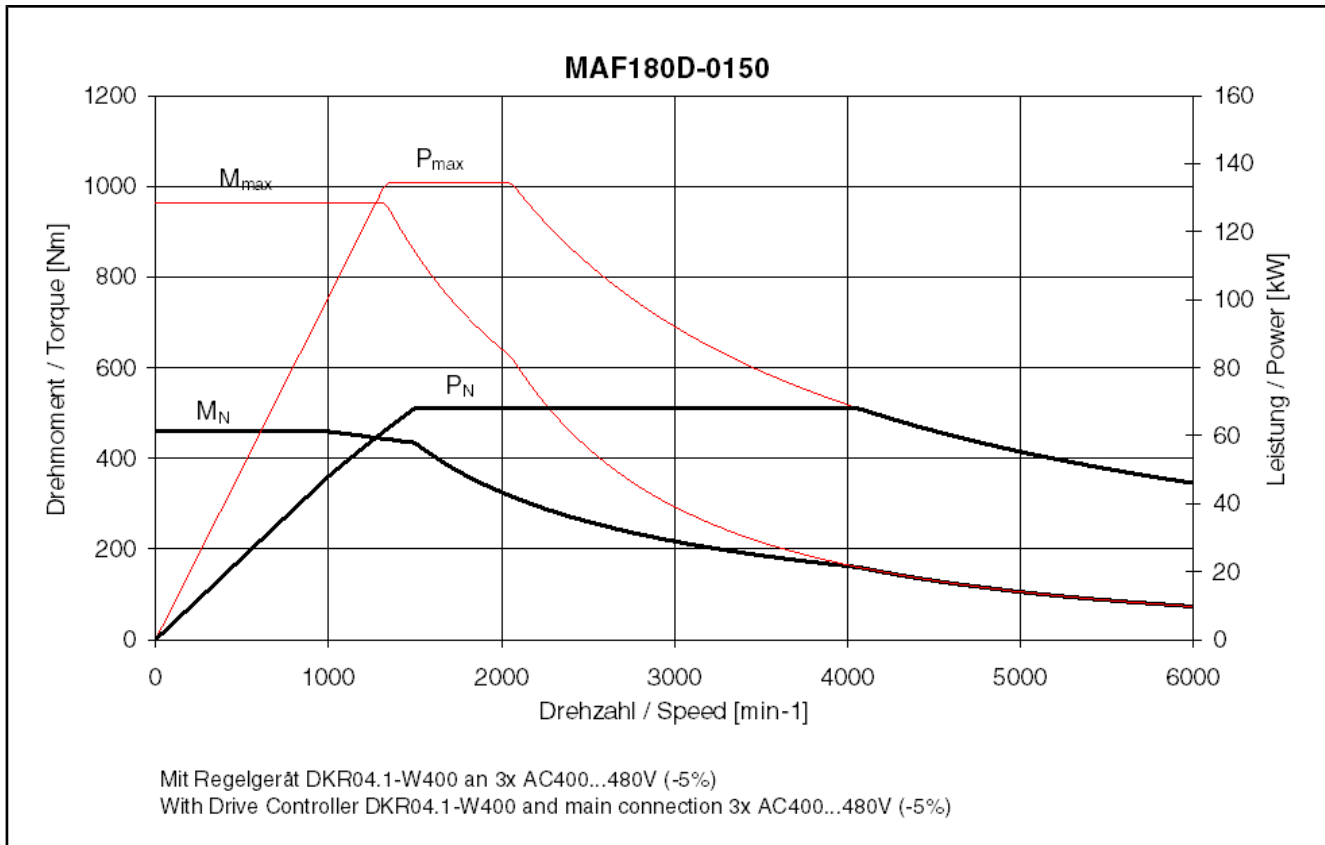

Fig.4-132: Motor characteristic curve of MAF180D-0150

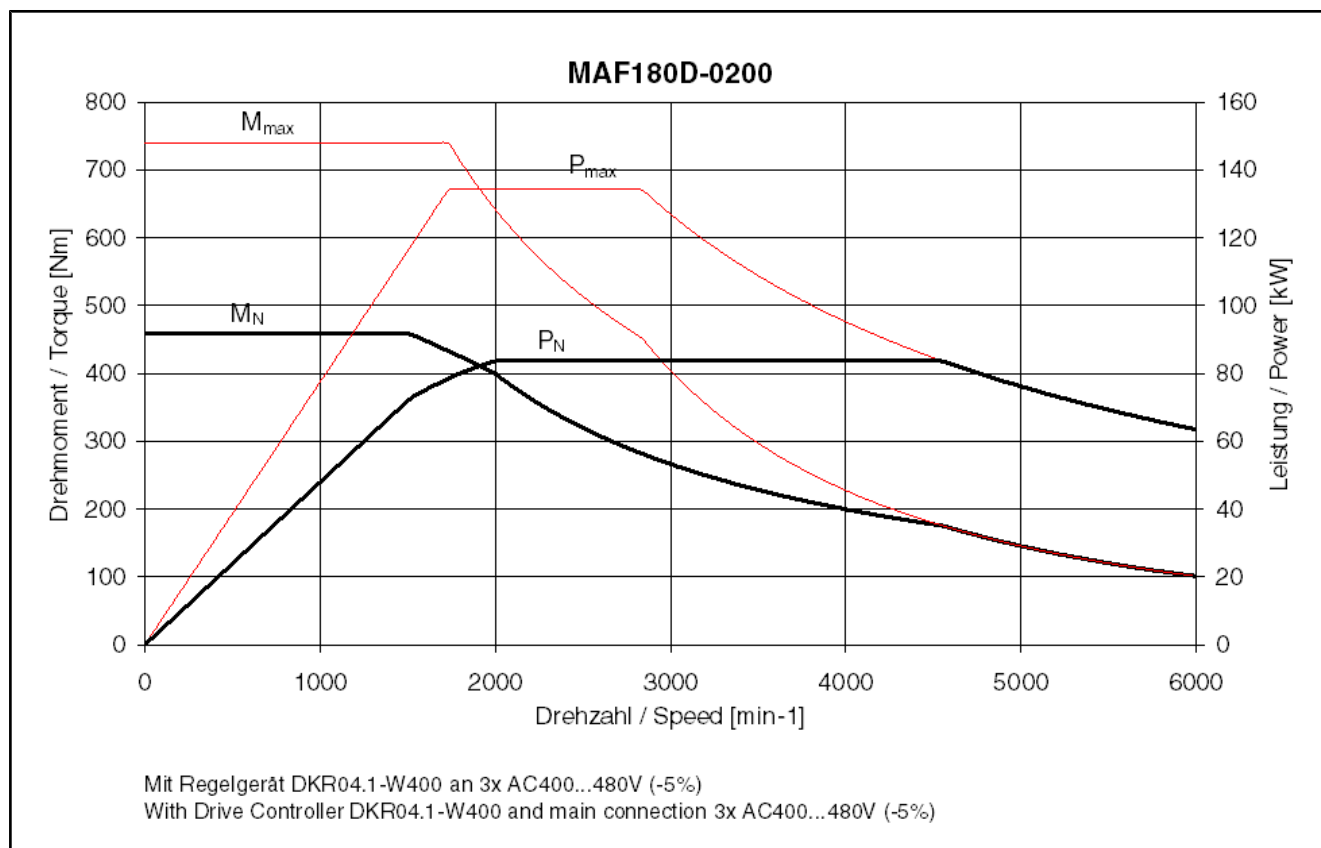

Fig.4-133: Motor characteristic curve of MAF180D-0200

4.11.5 Holding Brake MAD/MAF180 (Optional)

Data sheet - holding brake MAD/MAF180

Designation	Symbol	Unit	BRAKE 5	
			Electrically clamping	Electrically releasing
Holding torque	M ₄	Nm	300.0	240.0
Rated voltage	U _N	V	24	
Rated current	I _N	A	2.00	1.87
Holding brake moment of inertia	J _{br}	kg*m ²	0.018800	
Connection time	t ₁	ms	150	130
Disconnection time	t ₂	ms	90	300
Maximum holding brake speed	n _{Br_max}	min ⁻¹	6,000	

Last revision: 2006-10-20

Fig.4-134: Technical data of holding brake MAD/MAF180 (optional)

Technical Data

4.12 Technical Data of MAF225**4.12.1 Data Sheet MAF225C**

Data sheet MAF225C

Parameter	Symbol	Unit	MAF225C		
			0050*	0100	0150
Rated torque ¹⁾	M_N	Nm	860.0	820.0	764.0
Rated power	P_N	kW	45.03	85.90	120.01
Rated current	I_N	A	98.0	165.0	211.2
Rated speed	n_N	1/min	500	1,000	1,500
Key speed	n_1	1/min	500		1,000
Maximum torque	M_{max}	Nm	1,750.0		
Maximum power	P_{S6max}	kW	92.31	200.00	246.02
Maximum current	$I_{max(eff)}$	A	207.6	355.0	489.2
Maximum speed with bearing N	n_{max}	1/min	3,000	3,750	
Maximum speed with bearing V	n_{max}	1/min	3,000	3,750	
Continuous torque at standstill	M_{n1}	Nm	860.0	950.0	825.0
Continuous current at standstill	I_{n1}	A	98.0	183.0	228.0
Torque constant at 20 °C	$K_{M,N}$	Nm/A	9.74	5.21	3.75
Thermal time constant	T_{th}	min	3.5		
Cycle duration (S6 - 44%)	T_C	min	5		
Discharge capacity of the component	C_{ab}	nF	40.0	39.7	43.9
Number of pole pairs	p	--	3		
Power wire cross-section	A	mm ²	35.0	2 x 35.0	2 x 50.0
Mass	m_{mot}	kg	587.0		
Rotor moment of inertia	J_{rot}	kg * m ²	1.6500000		
Sound pressure level	L_P	dB[A]	75 (+3)		
Ambient air temperature during operation	T_{um}	°C	0...+40		
Insulation class according to DIN EN 60034-1	---	-	155		
Data on liquid cooling					
Power loss to be dissipated	P_V	kW	6.40	6.62	8.02
Coolant supply temperature	T_{ein}	°C	10 ... 40		

Last revision: 2010-11-05

Technical Data

Parameter	Symbol	Unit	MAF225C		
			0050*	0100	0150
Allowed coolant temperature rise at P_V	ΔT_{max}	K	10		
Pressure drop at Q_{min}	Δp	bar	0.4		0.6
Constant for determining the pressure drop with water as cooling medium	$K_{\Delta p}$	-	0.01		
Coolant flow required at P_V	Q_{min}	l/min	9.2	9.5	11.5
Coolant duct volume	V_{kuehl}	l	1.86		
Maximum allowed input pressure	p_{max}	bar	6.0		

Last revision: 2010-11-05

1) Please note the information on the specified parameters at the beginning of this chapter

* Provisional values

Fig.4-135: Technical data of MAF225

4.12.2 Motor Characteristic Curves of MAF225C

Motor characteristic curve of MAF225C-0050 (in preparation)

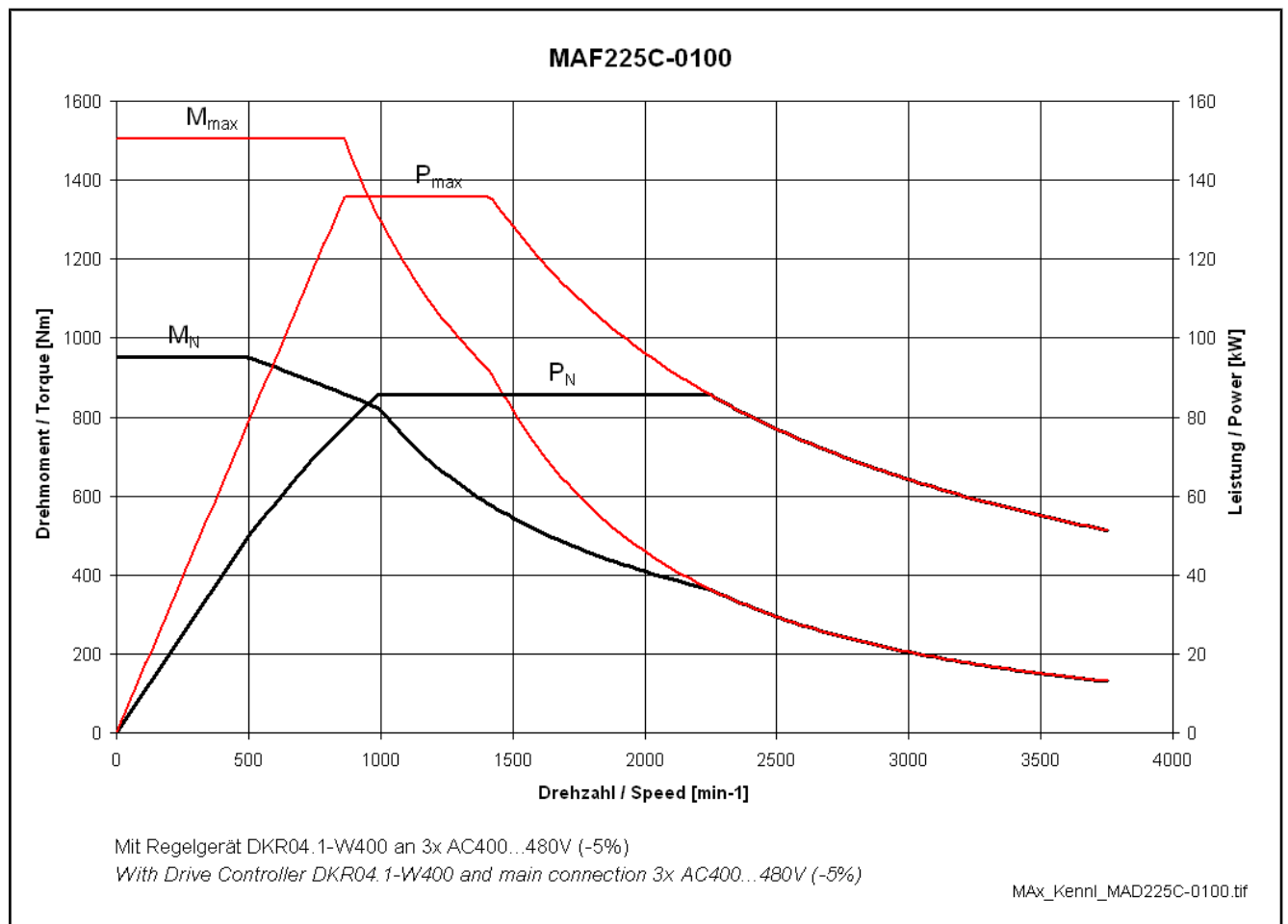

Fig.4-136: Motor characteristic curve MAF225C-0100

Technical Data

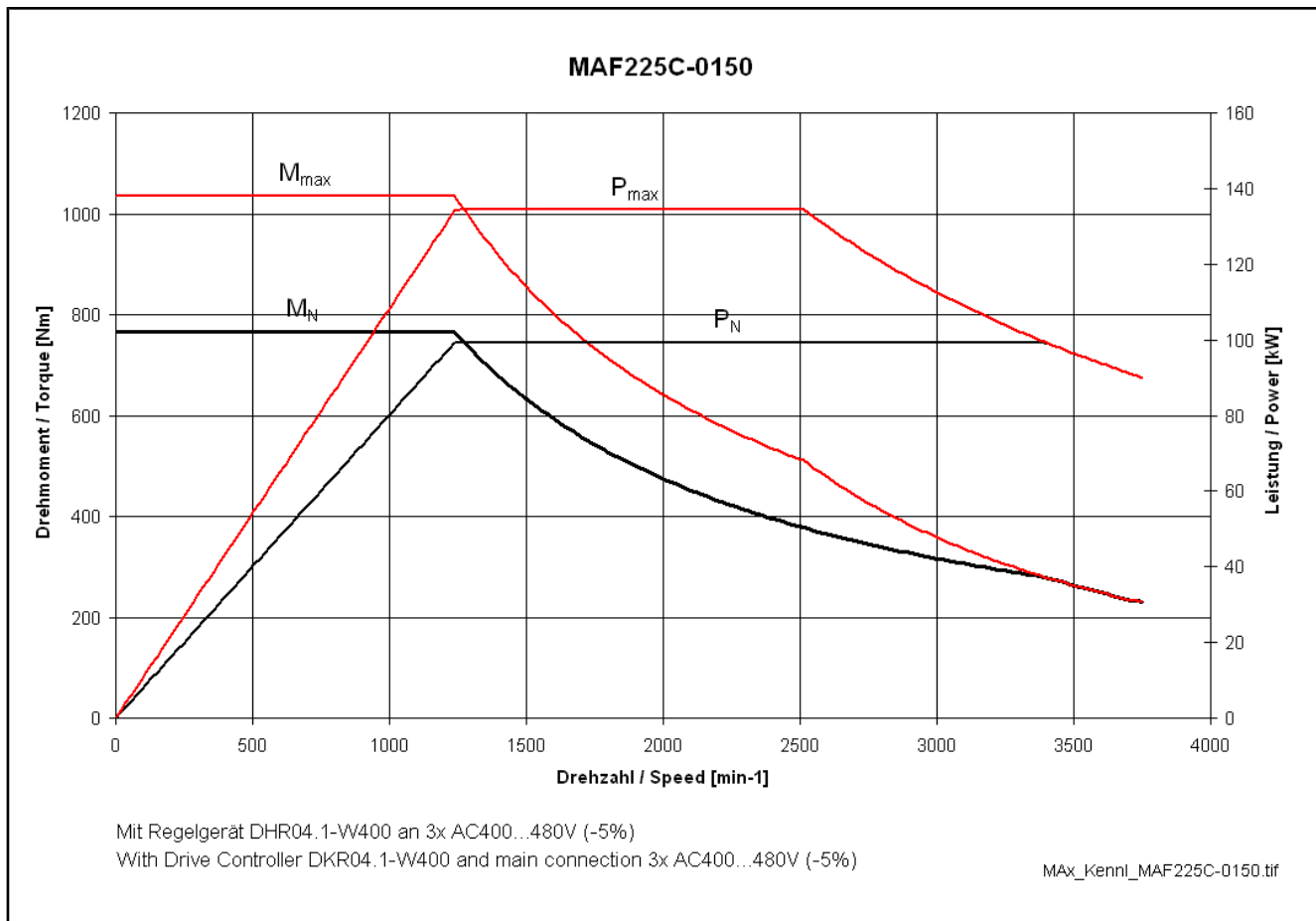

Fig.4-137: Motor characteristic curve MAF225C-0150

5 Dimension Drawings IndraDyn A

5.1 Frame Size MAD100

5.1.1 MAD100 without Brake

Technical Drawing Details:

- Front View (Top):** Shows the motor's footprint with dimensions: 208 (total width), 192 (motor body width), 50 (encoder offset), 25° (encoder angle), 4x M10x15 (encoder screws), 4x Ø14 (encoder holes), 250 (motor body width), 215 (motor body width), 244 (total width), 164 (encoder offset).
- Side View (Left):** Shows the motor's profile with dimensions: 11 (encoder offset), 79 (encoder height), 25 (encoder thickness), 78 (motor body height), 18 (motor body height), 45 (motor body height), 4 (motor body height), 60 (motor body height), 273 (total height), 71 (motor body height), k (total height), m* (Geber/encoder) (encoder offset).
- Side View (Right):** Shows the motor's profile with dimensions: 171 (total height), 100 (motor body height), 12 (motor body height), 11 (motor body height), 63 (motor body height), a (motor body height), 186 (total height), 85 (motor body height), 30 (motor body height), 191 (motor body height), 100 (motor body height), 160 (motor body height), 100 (motor body height), B35 (motor body height), B05 (motor body height).
- Detail View (Bottom):** Shows the labyrinth sealing detail with dimensions: 4, 1.5, 39.5, 50, Ø120, Ø5.
- Dimensions:** A-Seite/side, B-Seite/side, Maß/dimension "s", h=5^{+0.2}, 10 N9 (-0.036), Ø32 K6 (+0.002), Ø130 J6 (-0.014), 5, 45, 4, 60, 18, 78, 79, 25, 11, m* (Geber/encoder), 71, k, 12, 100, 171, 11, 63, a, 186, 85, 30, 191, 100, 160, 100, B35, B05.
- Notes:**
 - * Bei Motoren ohne Geber entfällt das Maß "m" dimension "m" not applicable for motors without encoder
 - Maß/dimension "s"
 - Labyrinthdichtung/labyrinth sealing
- Table of Motor Variants:**

Typ	k [mm]	l1 [mm]	l2 [mm]	m [mm]	a [mm]	s [mm]
MAD100B	462	247	203	329	80	78
MAD100C	537	322	278	404	140	153
MAD100D	612	397	353	479	215	228
- Technical Drawing Information:**

Desig.	106-0425-3003-00	Rev.	00
Proj.	106-0425-3003-00	Rev.	00
Zeich.-Nr.	106-0425-3003-AB	Rev.	00
Blatt	1	von	1
Bezeichnung	MAD100-OHNE BREMSE		

Ers. für: 106-0425-3003-00
 Ers. durch: 5882
 k.Nr.: ...
 Zeichnung darf nur mit CAD geändert werden.

Dimension Drawings IndraDyn A

5.1.2 MAD100 with Brake 1 or 5

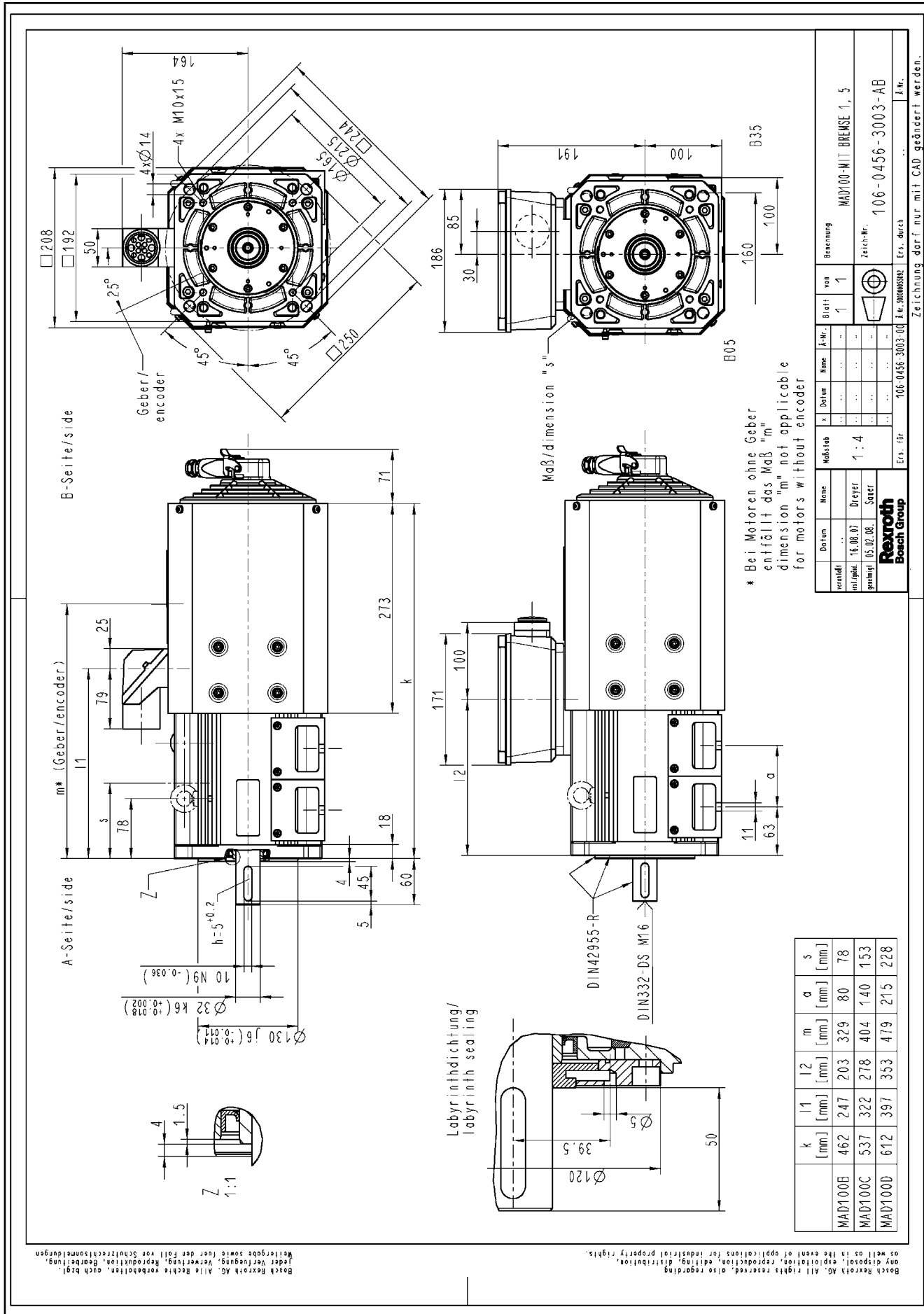

Fig.5-2: MAD100 with brake 1/5

5.1.3 MAD100 with Fan Shroud, without Brake

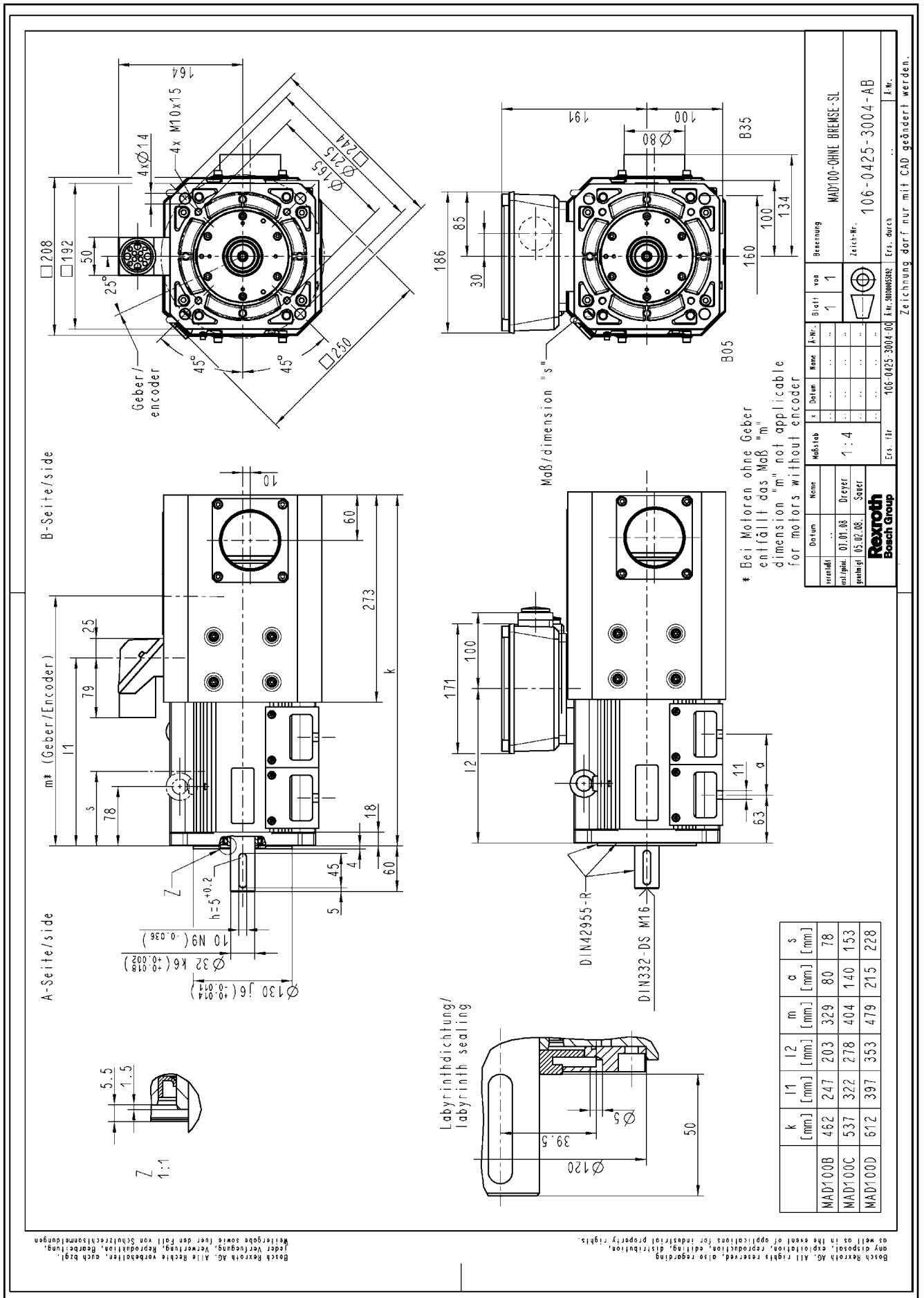

Fig.5-3: MAD100 with SL cooling, without brake

Dimension Drawings IndraDyn A

5.1.4 MAD100 with Fan Shroud, Brake 1 or 5

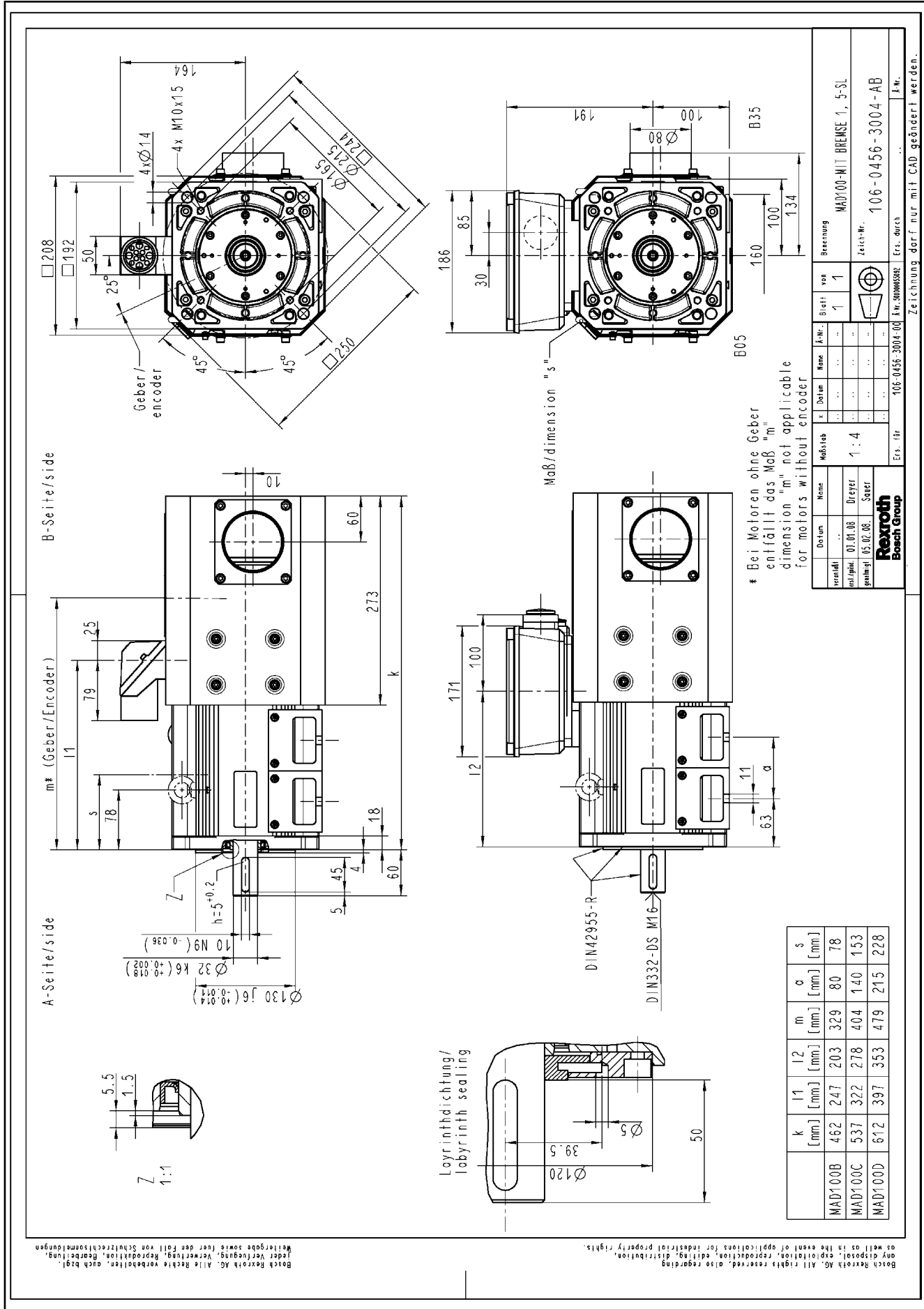

Fig.5-4: MAD100 with SL cooling, brake 1/5

5.1.5 MAD100 in Ex-type Design with M6 or S6 Encoder, without Brake

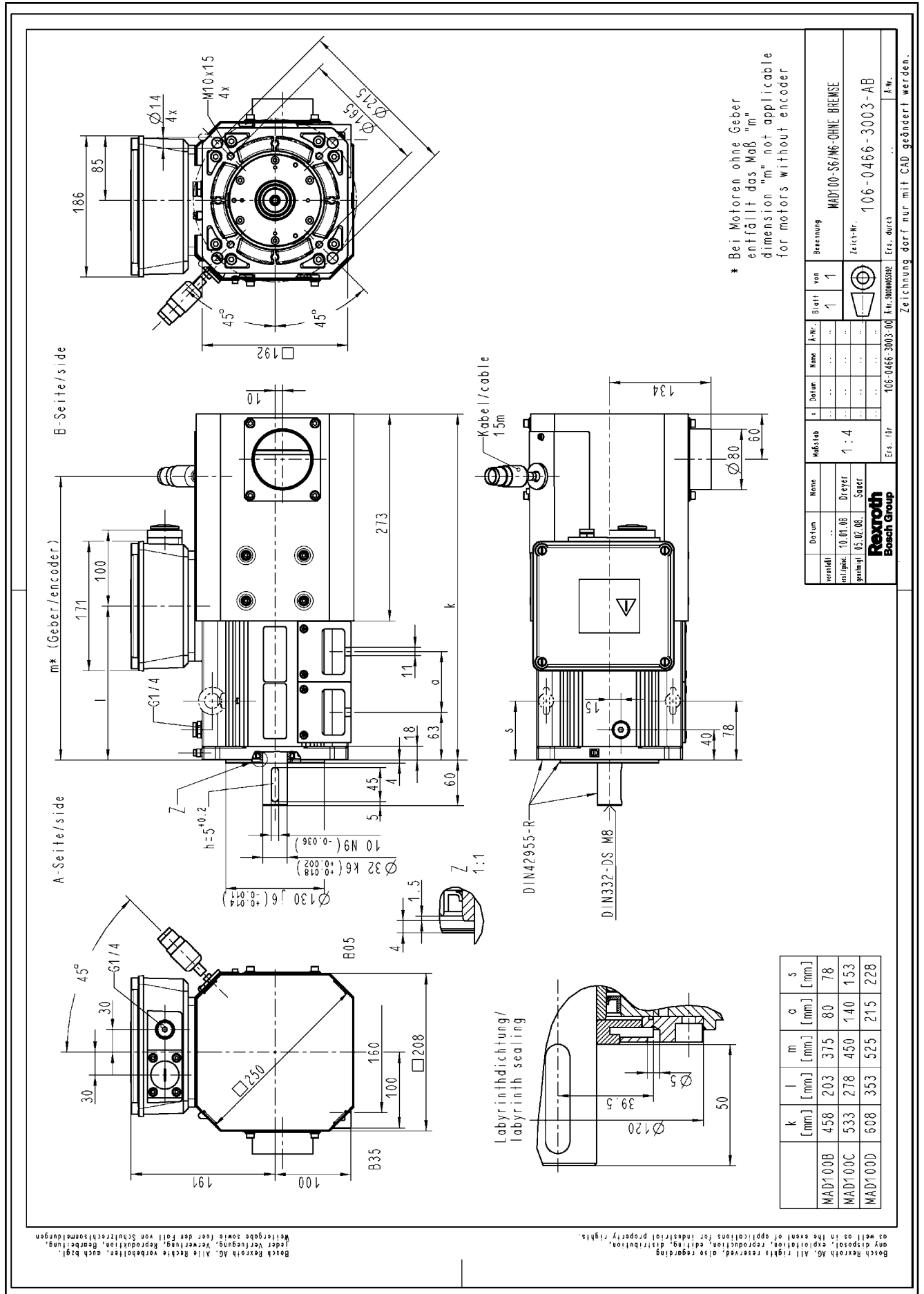

Fig.5-5: MAD100 with M6/S6 encoder, without brake

Dimension Drawings IndraDyn A

5.1.6 MAD100 in Ex-type Design with M6 or S6 Encoder, Brake 1 or 5

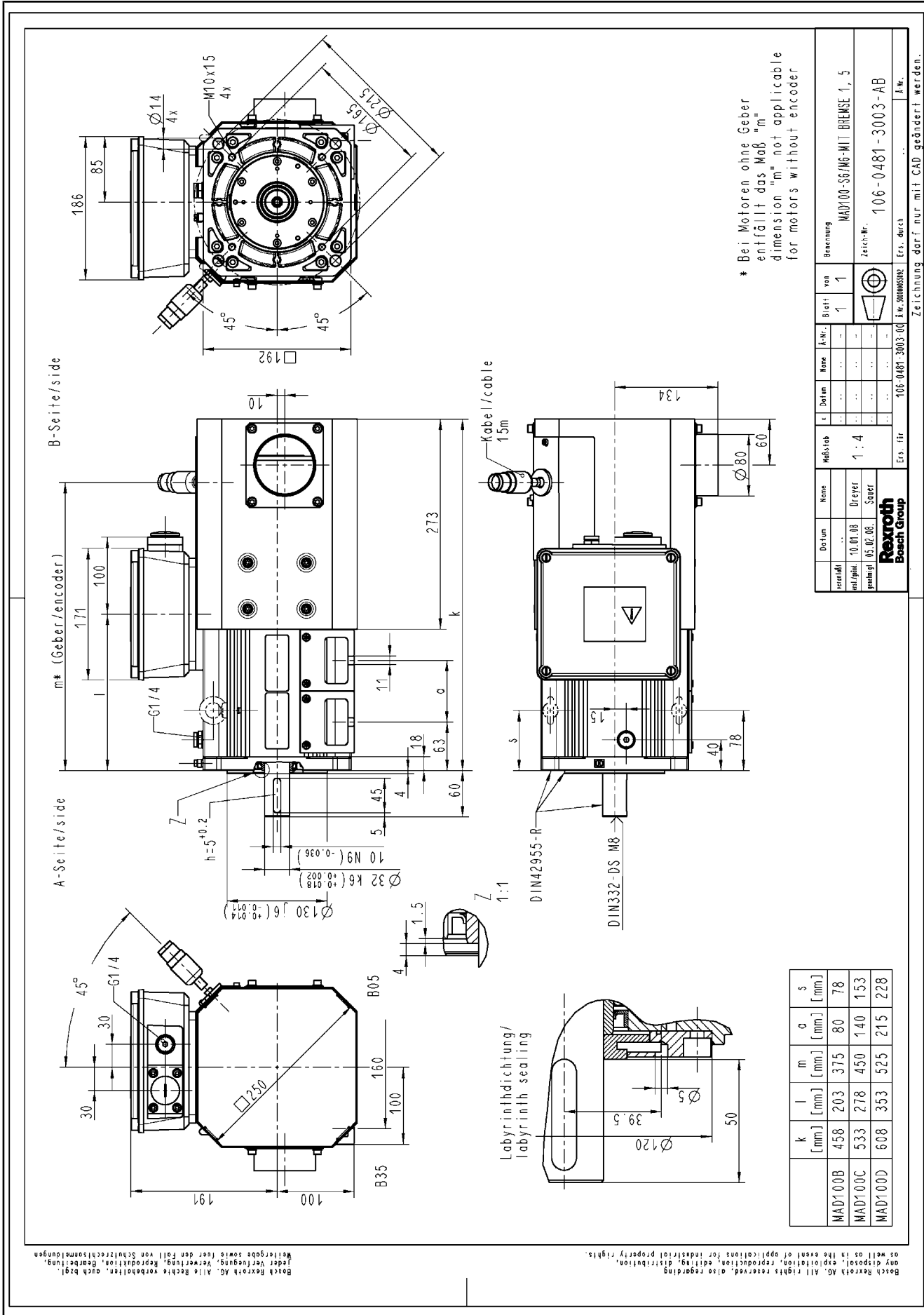
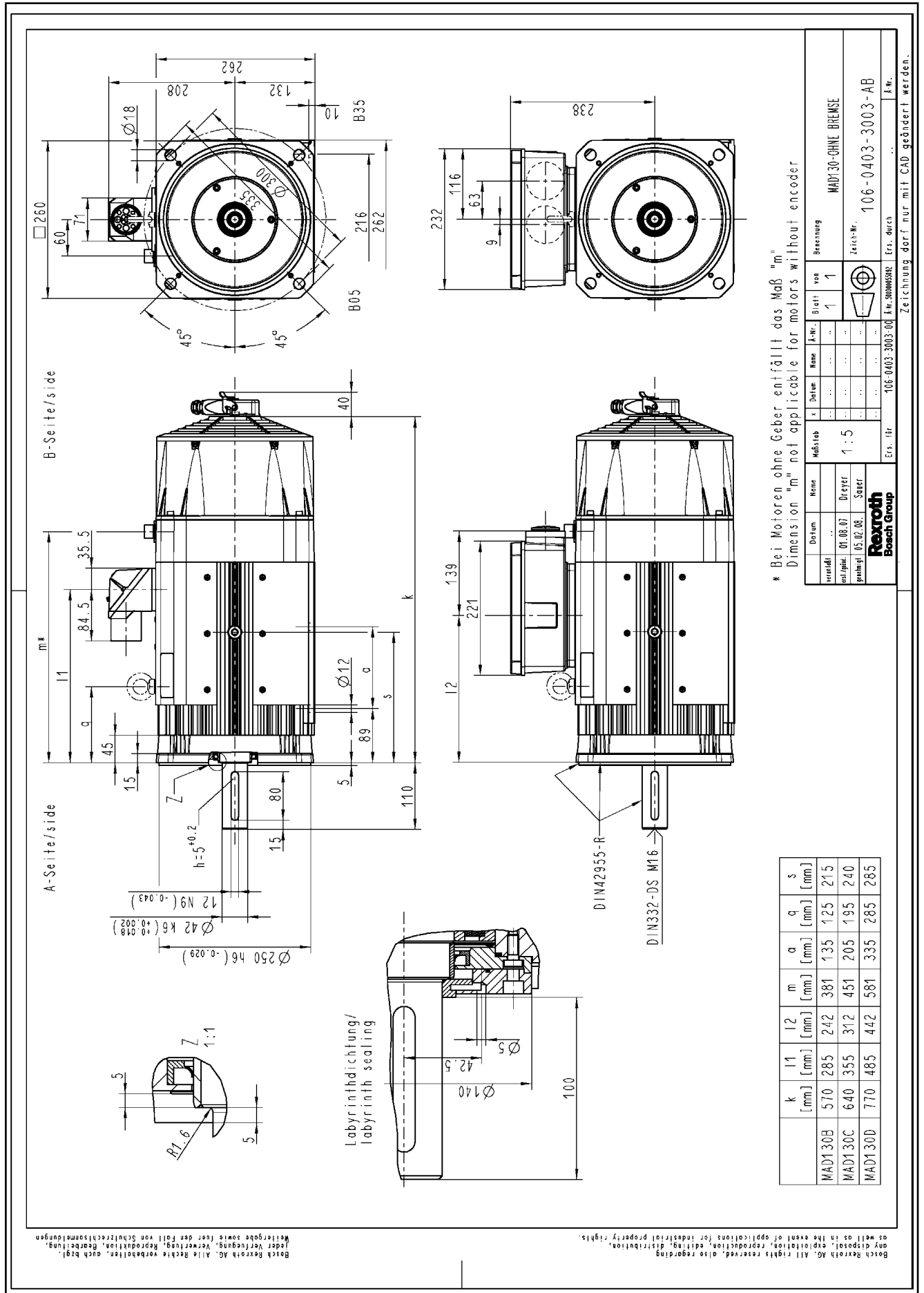

Fig.5-6: MAD100 with M6/S6 encoder, brake 1/5

5.2 Frame Size MAD130

5.2.1 MAD130 without Brake



Dimension Drawings IndraDyn A

5.2.2 MAD130 with Brake 1 or 5

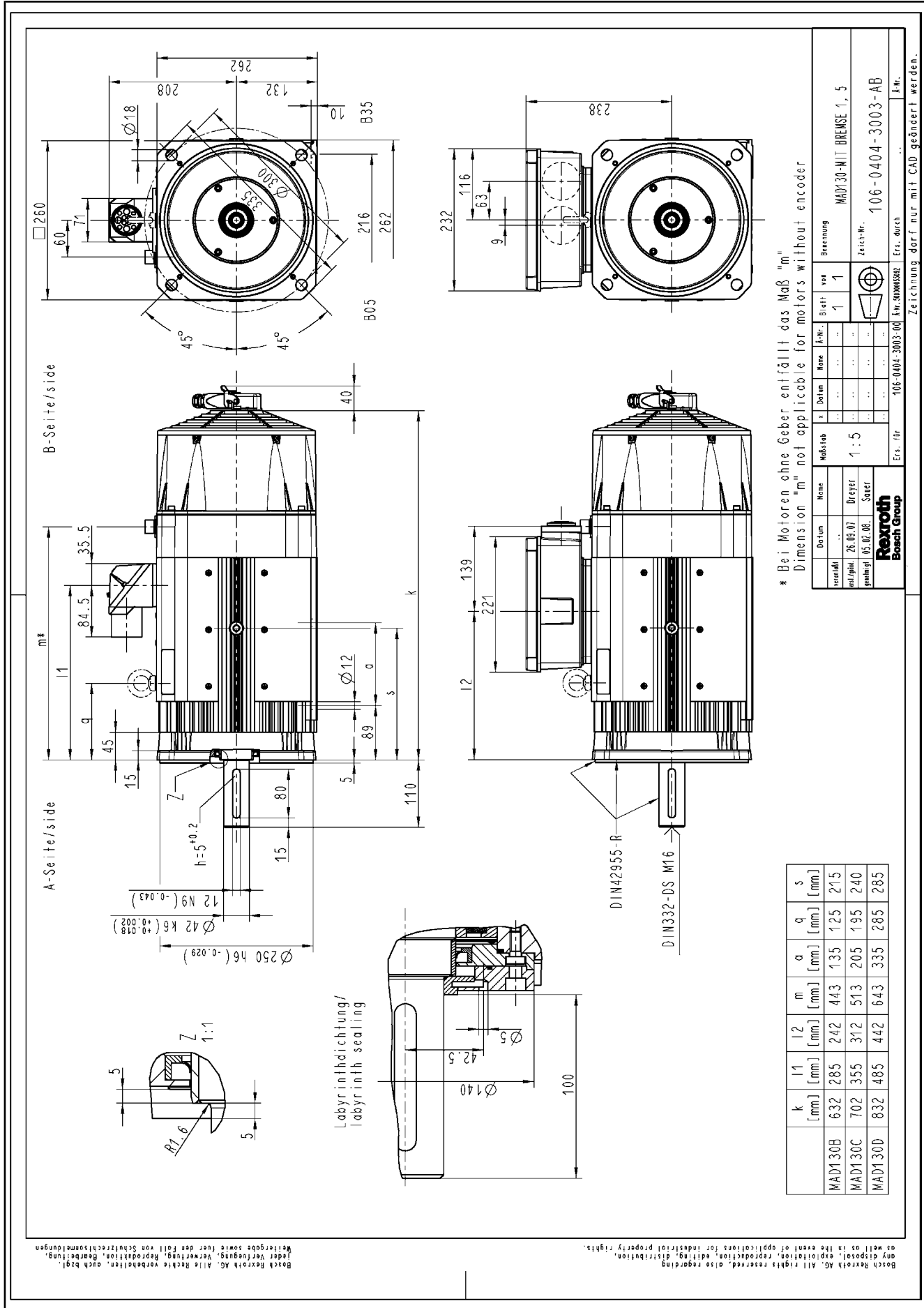

Fig.5-8: MAD130 with brake 1/5

5.2.3 MAD130 with Fan Shroud, without Brake

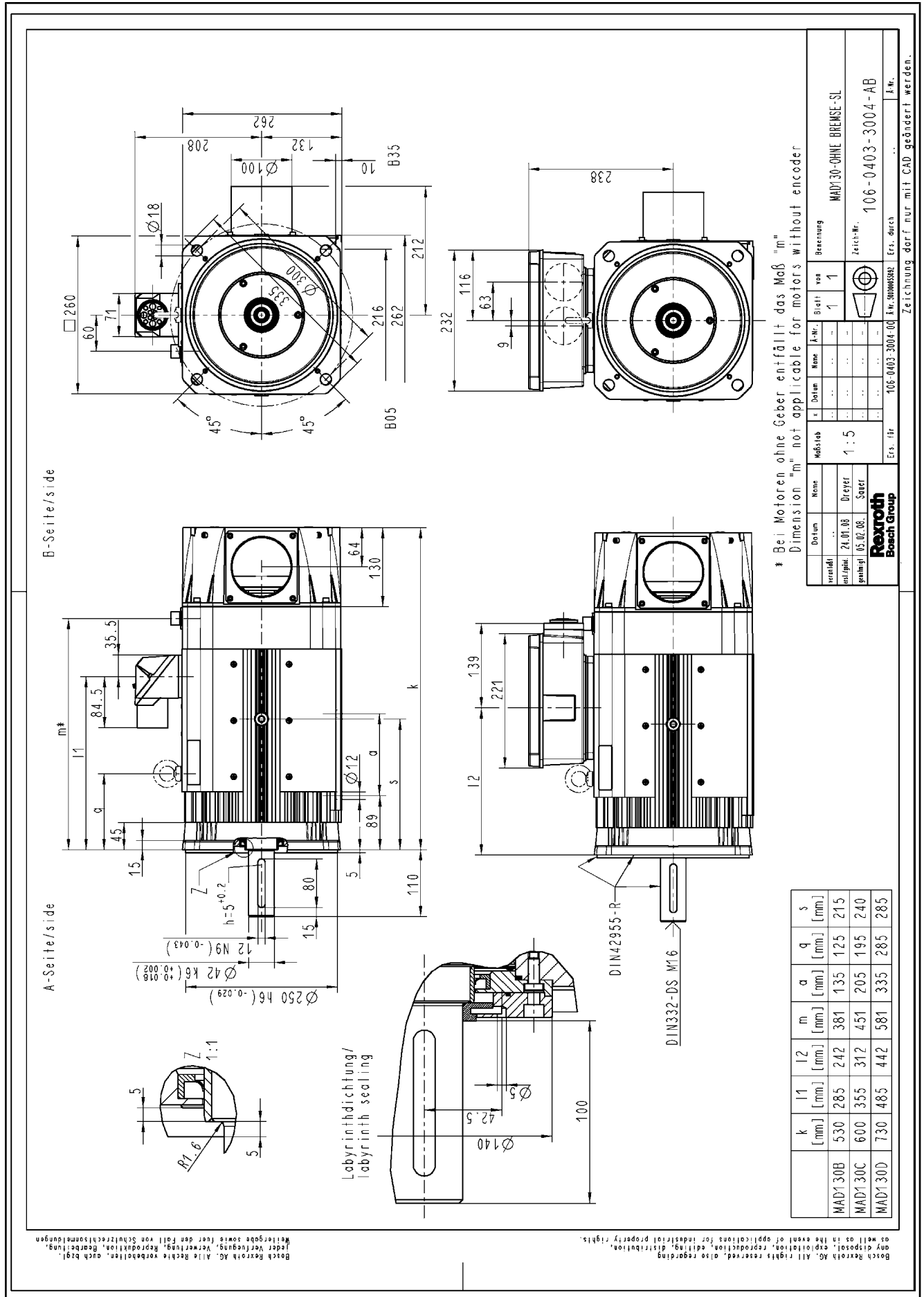

Fig.5-9: MAD130 with SL cooling, without brake

Dimension Drawings IndraDyn A

5.2.4 MAD130 with Fan Shroud, Brake 1 or 5

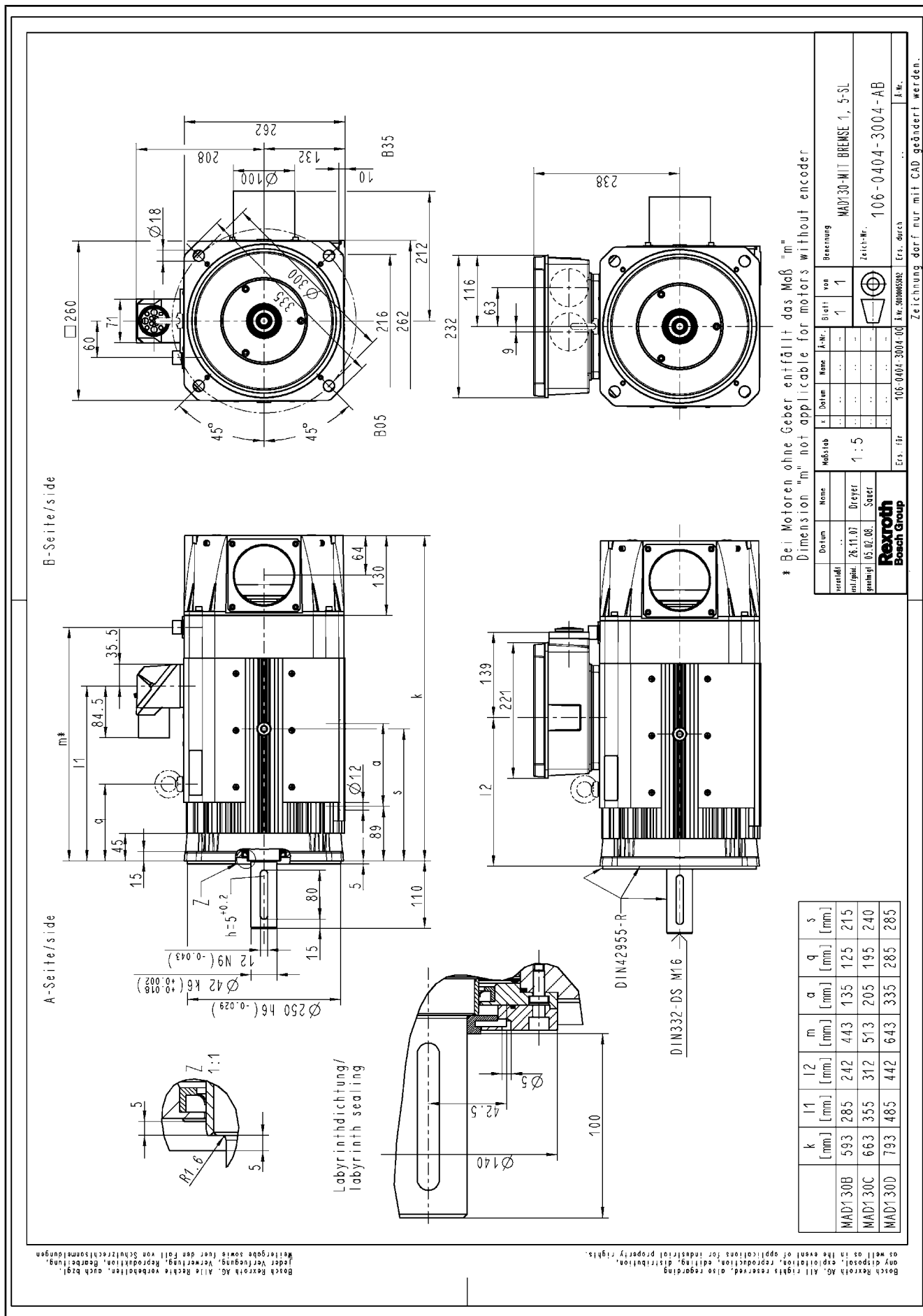

Fig.5-10: MAD130 with SL cooling, brake 1/5

5.2.5 MAD130 in Ex-type Design with M6 or S6 Encoder, without Brake

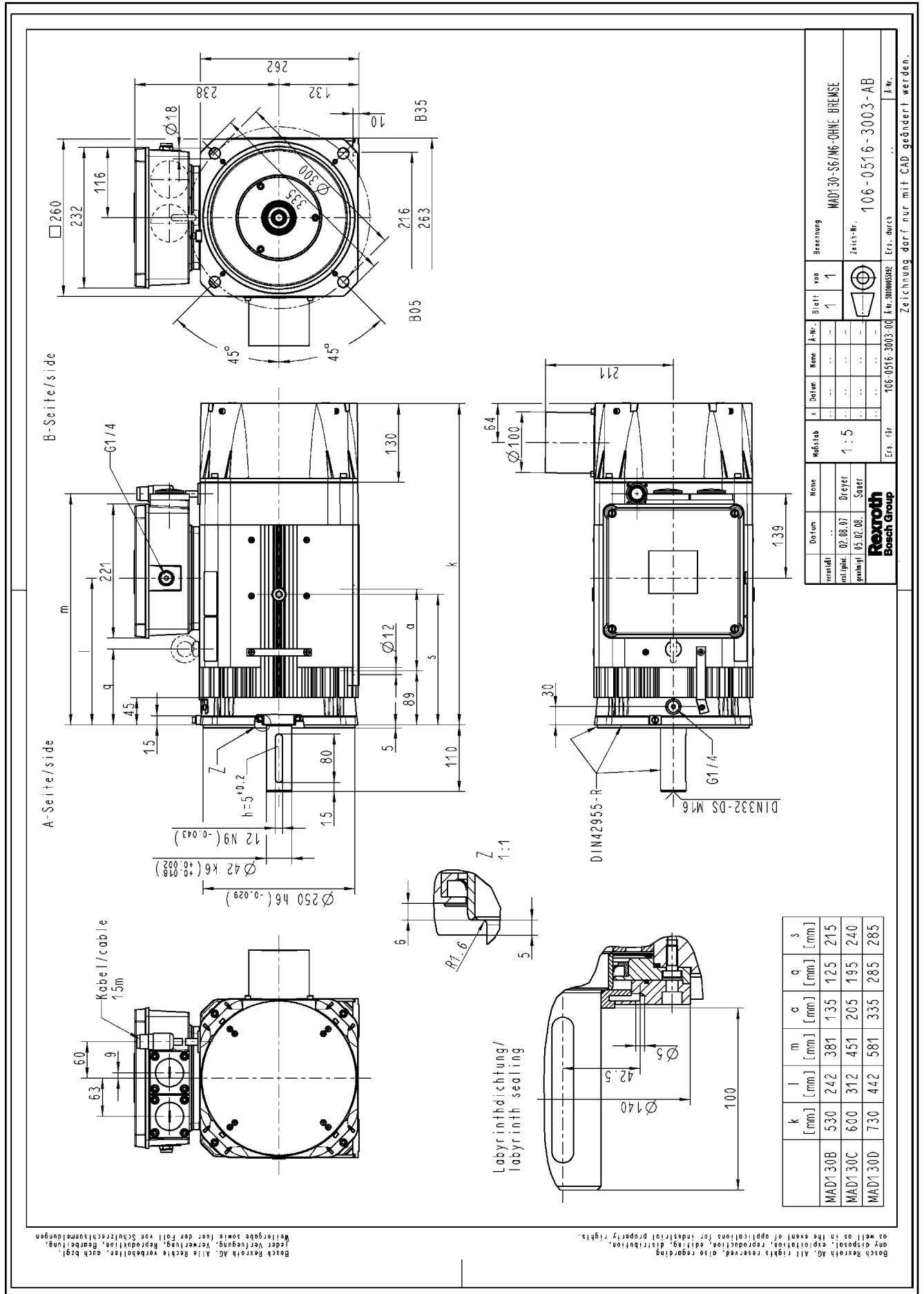

Fig.5-11: MAD130 with M6/S6 encoder, without brake

Dimension Drawings IndraDyn A

5.2.6 MAD130 in Ex-type Design with M6 or S6 Encoder, Brake 1 or 5

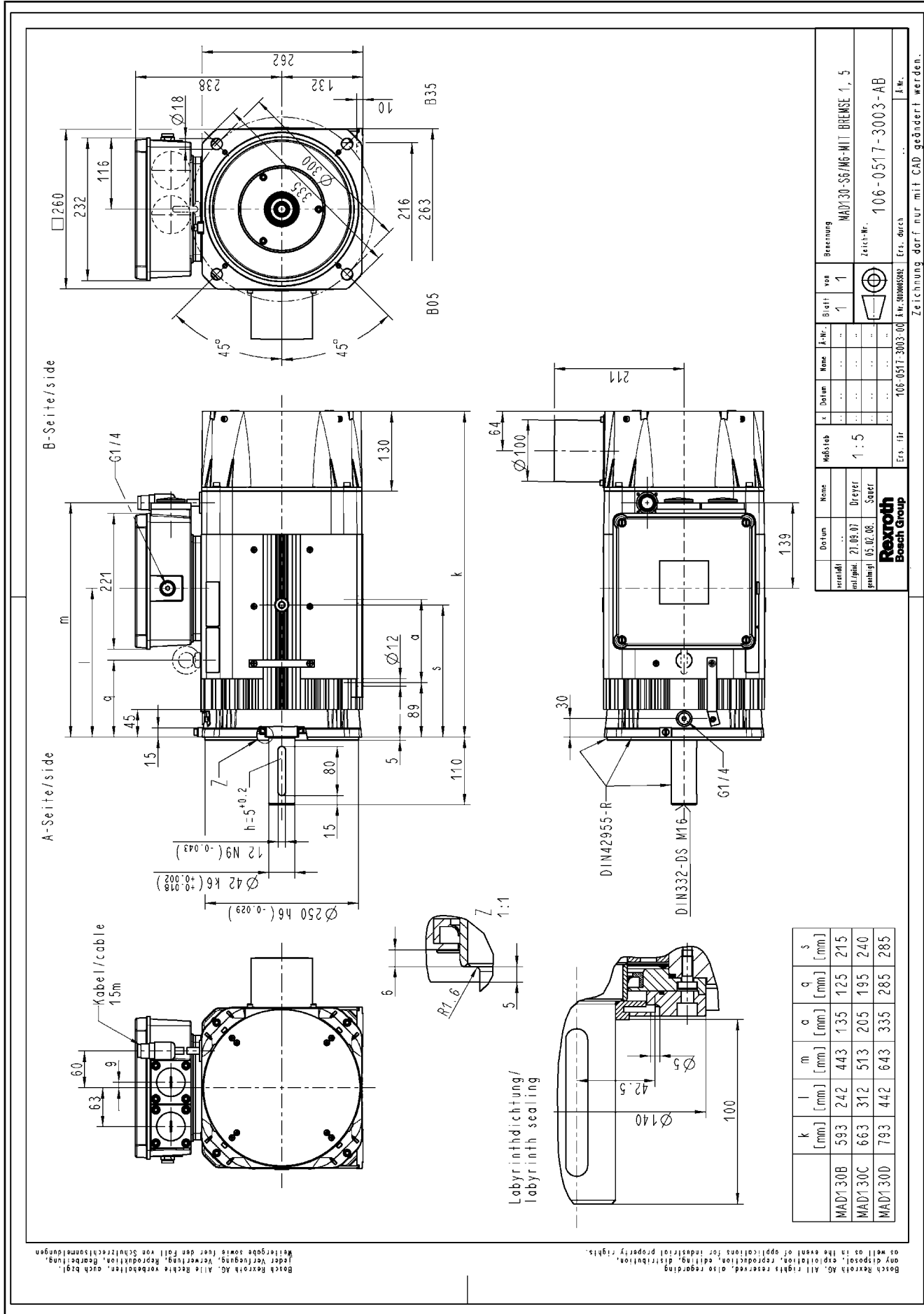
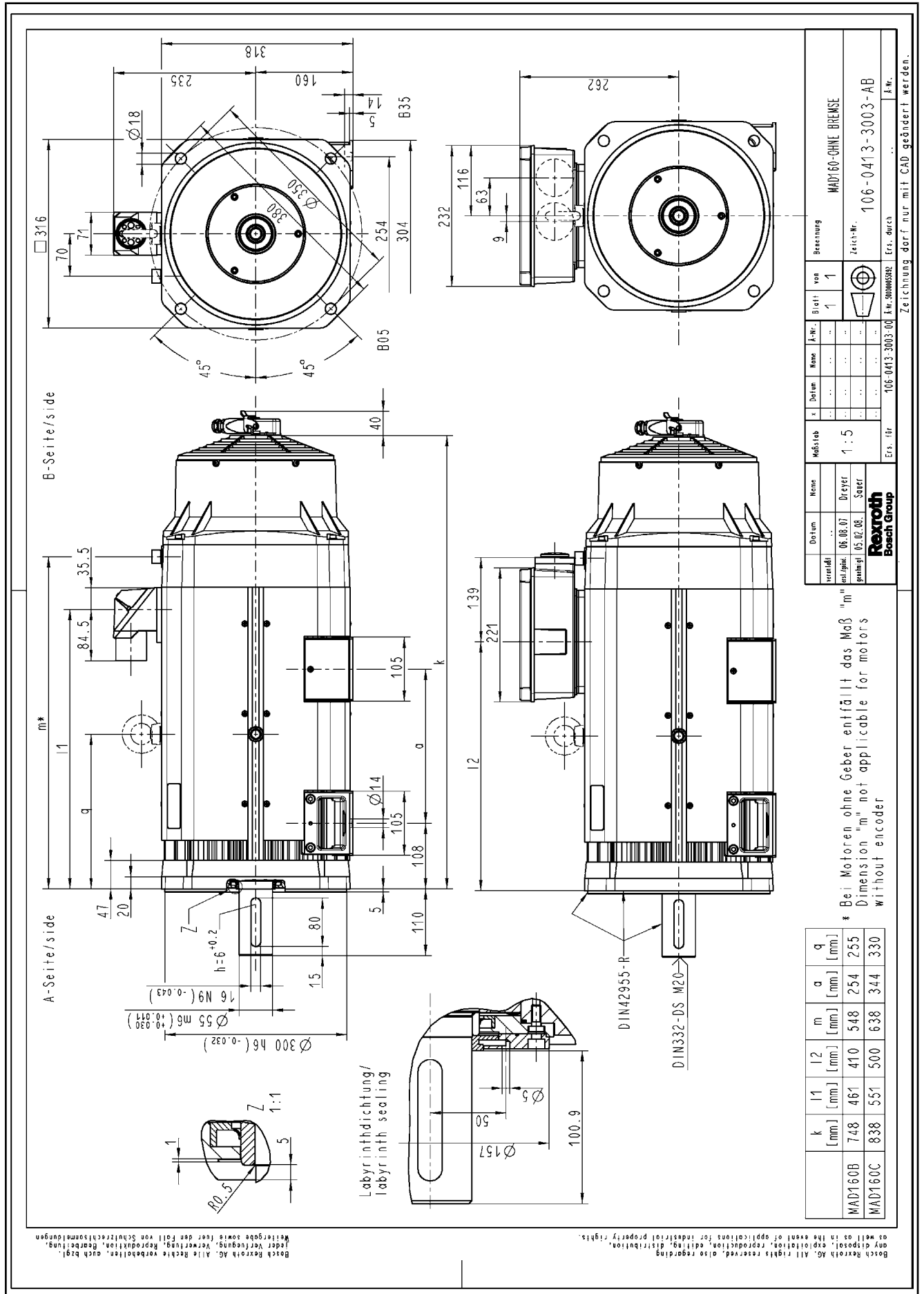

Fig.5-12: MAD130 with M6/S6 encoder, brake 1/5

5.3 Frame Size MAD160

5.3.1 MAD160 without Brake



Dimension Drawings IndraDyn A

5.3.2 MAD160 with Brake 1 or 5

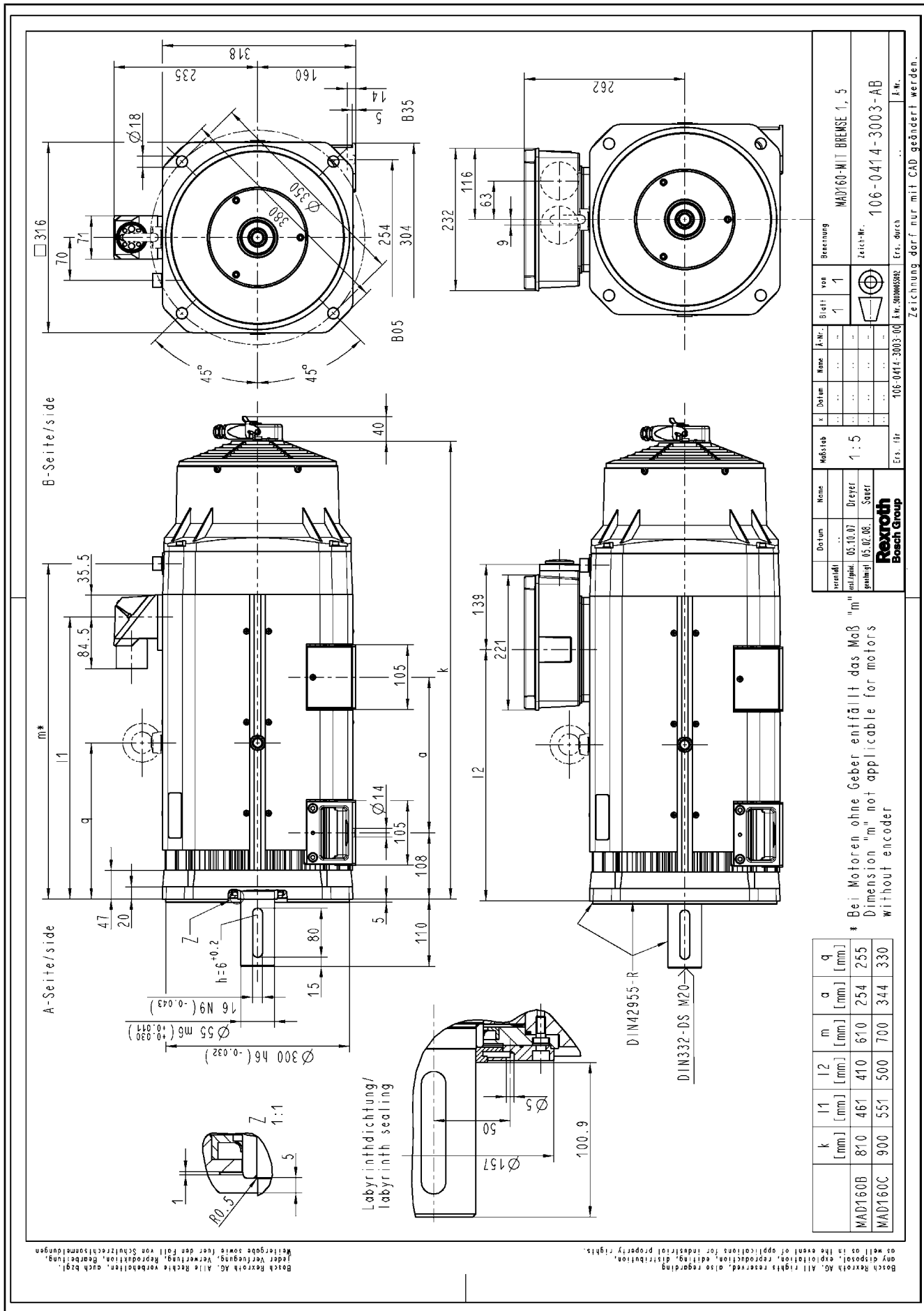

Fig.5-14: MAD160 with brake 1/5

5.3.3 MAD160 with Brake 3

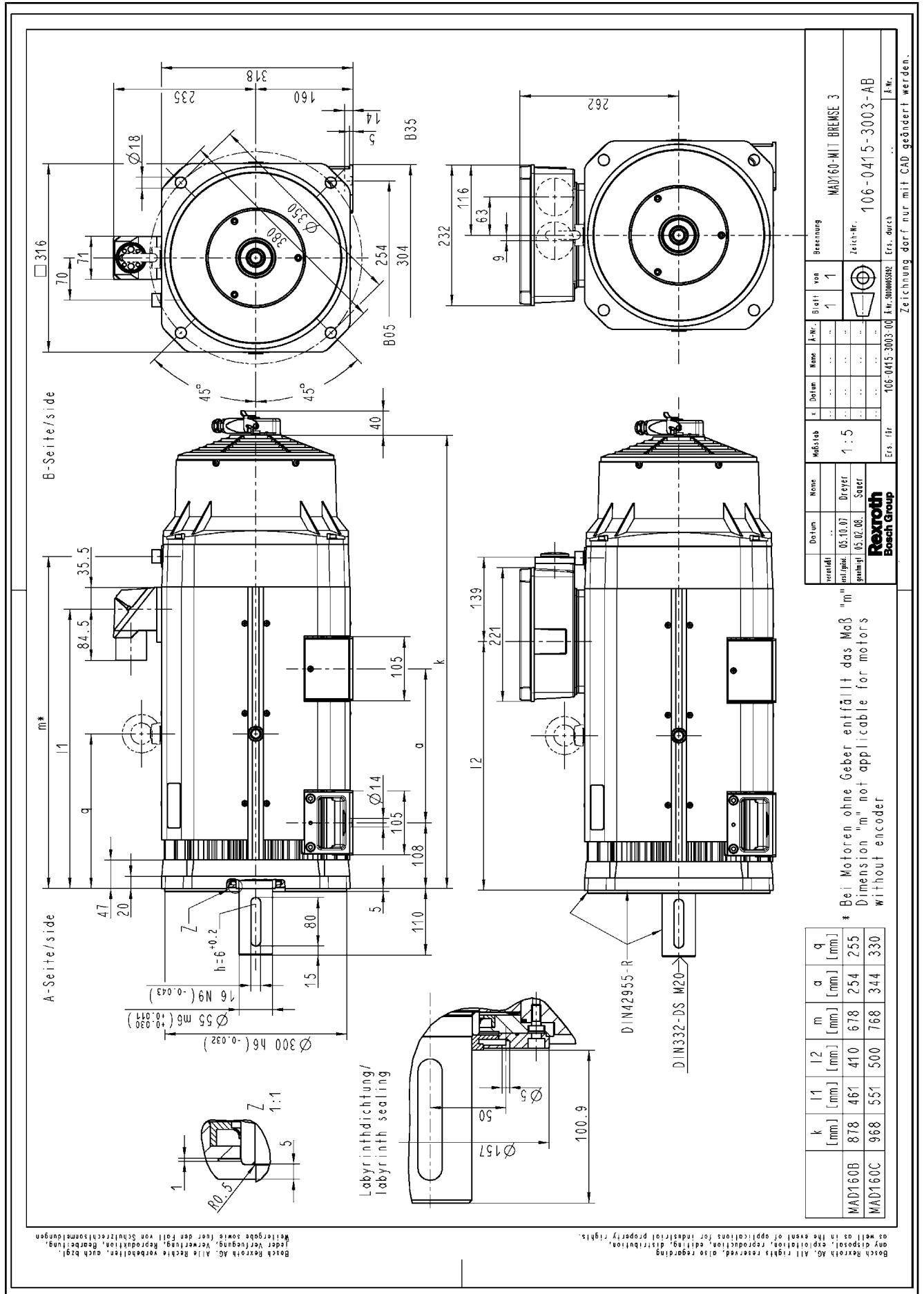
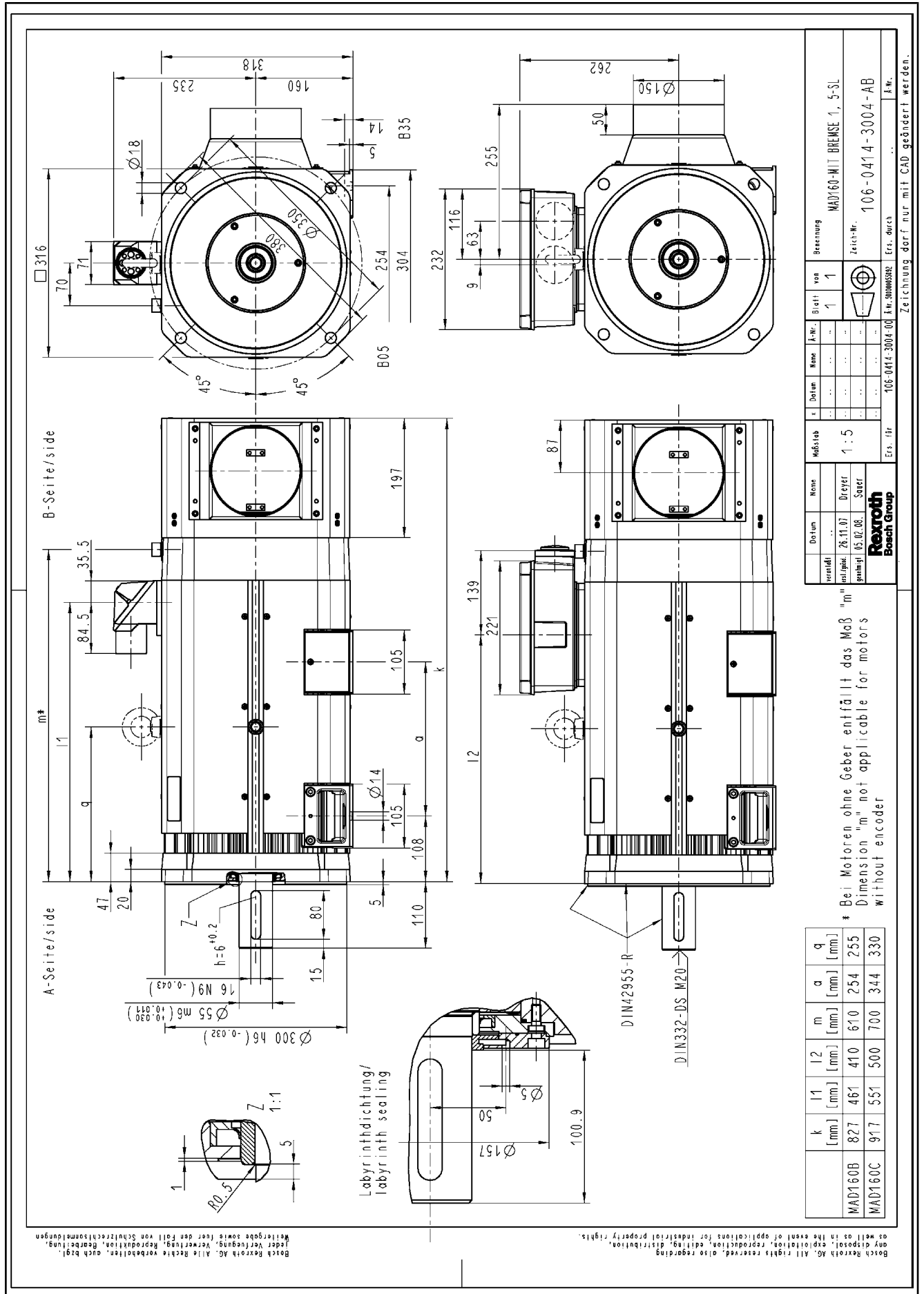

Fig.5-15: MAD160 with brake 3

5.3.5 MAD160 with Fan Shroud, Brake 1 or 5



Dimension Drawings IndraDyn A

5.3.6 MAD160 with Fan Shroud and Brake 3

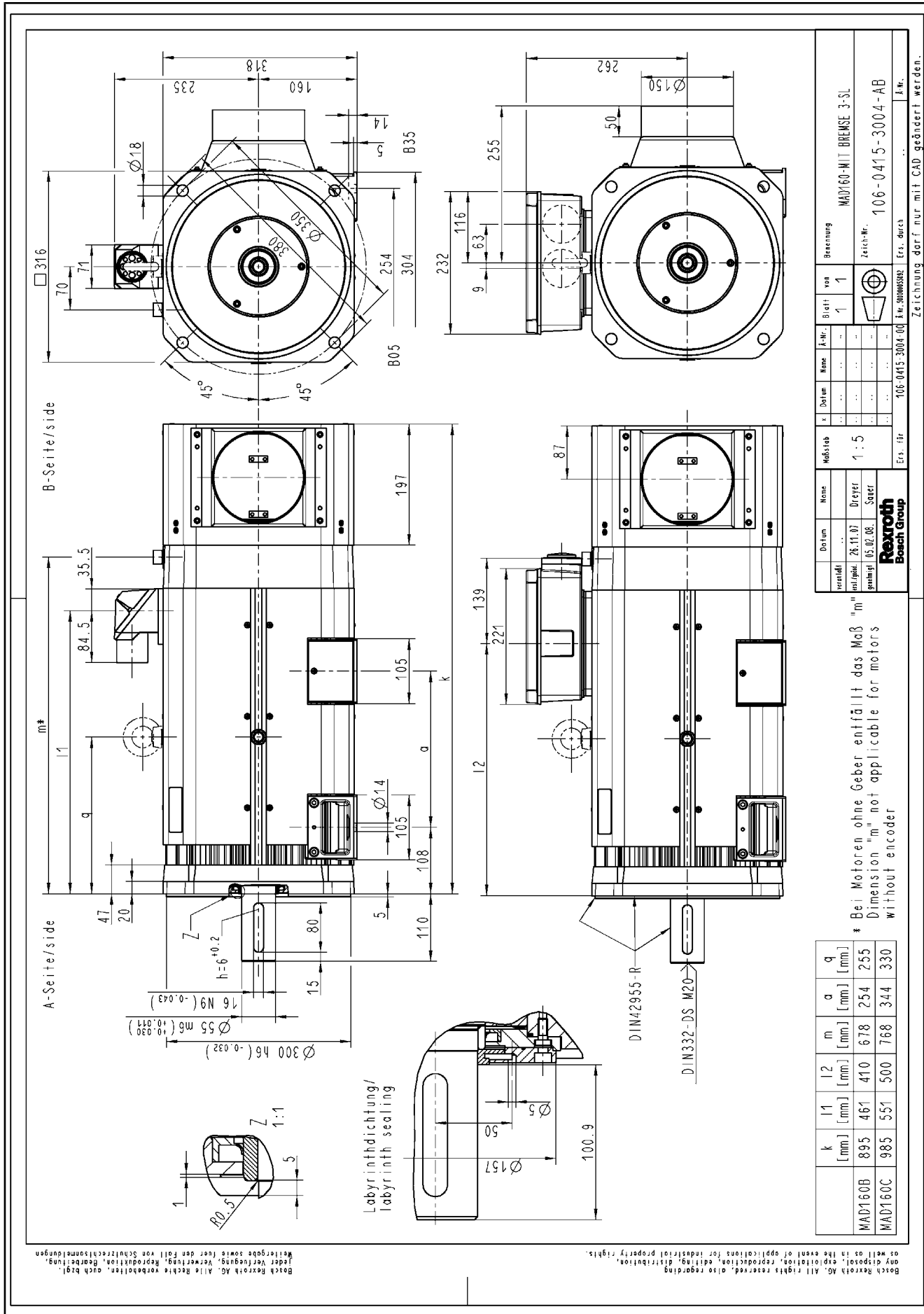

Fig.5-18: MAD160 with SL cooling, brake 3

5.3.7 MAD160 in Ex-type Design with M6 or S6 Encoder, without Brake

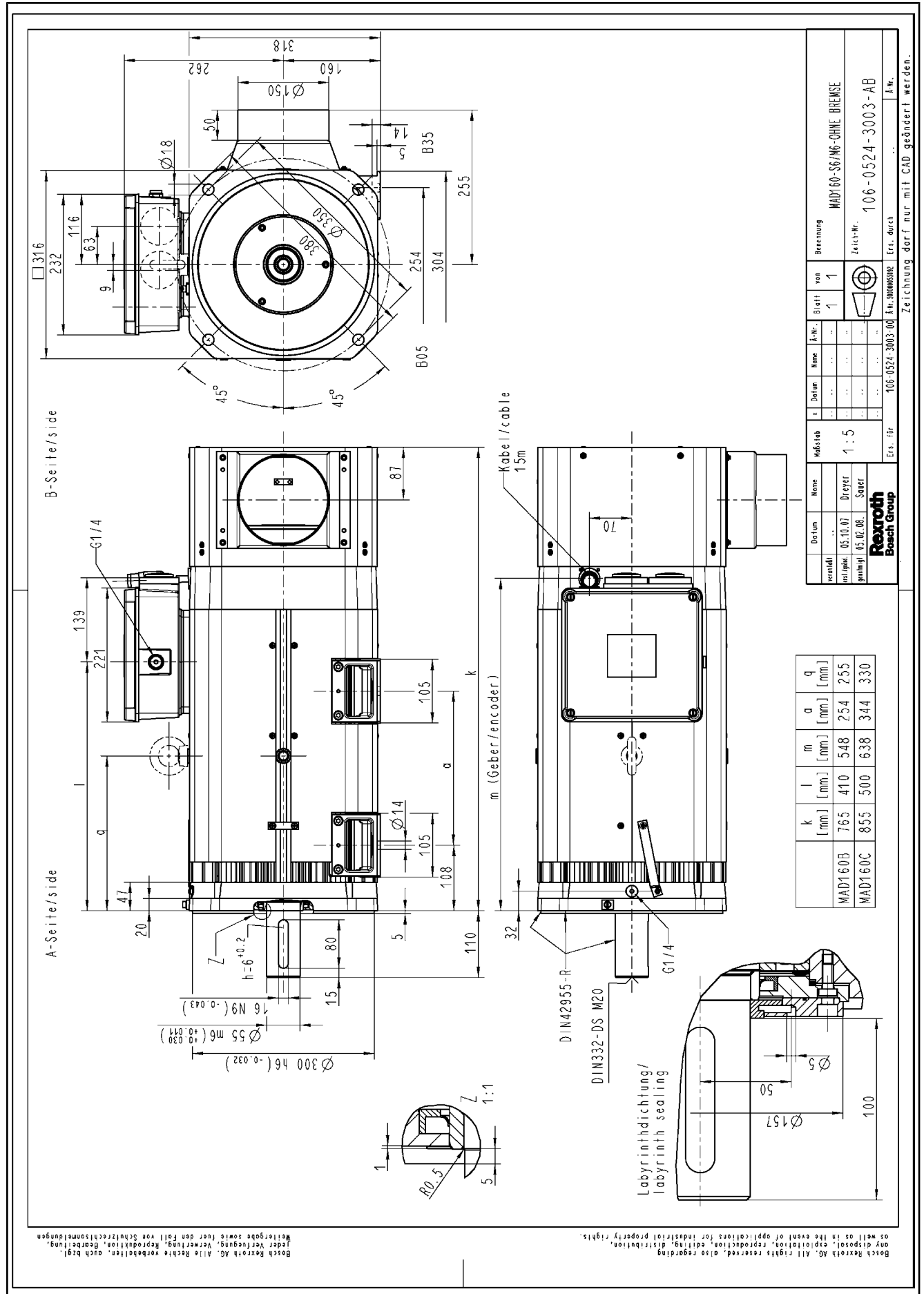

Fig.5-19: MAD160 with M6/S6 encoder, without brake

Dimension Drawings IndraDyn A

5.3.8 MAD160 in Ex-type Design with M6 or S6 Encoder, Brake 1 or 5

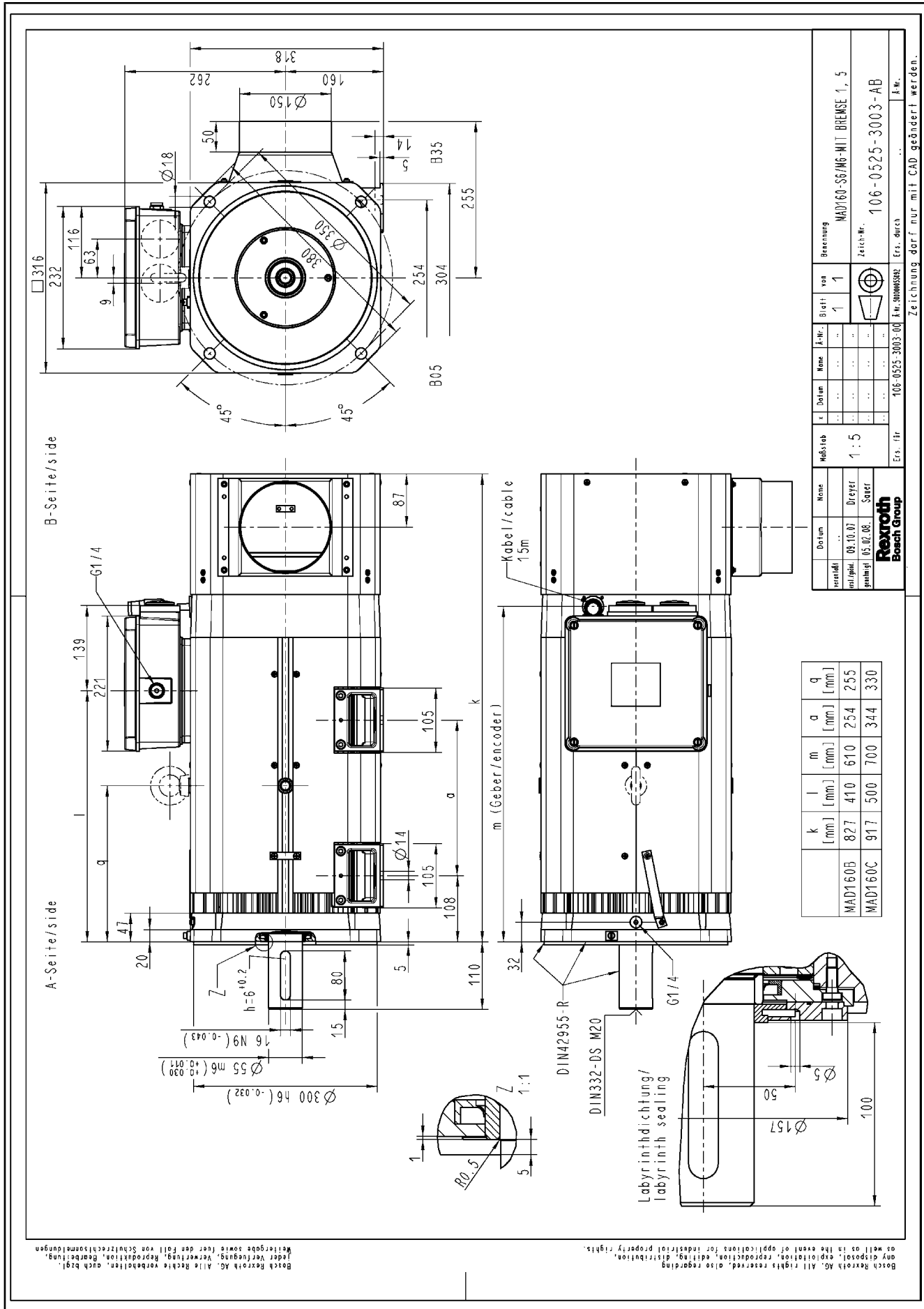

Fig.5-20: MAD160 with M6/S6 encoder, brake 1/5

5.3.9 MAD160 in Ex-type Design with M6 or S6 Encoder, Brake 3

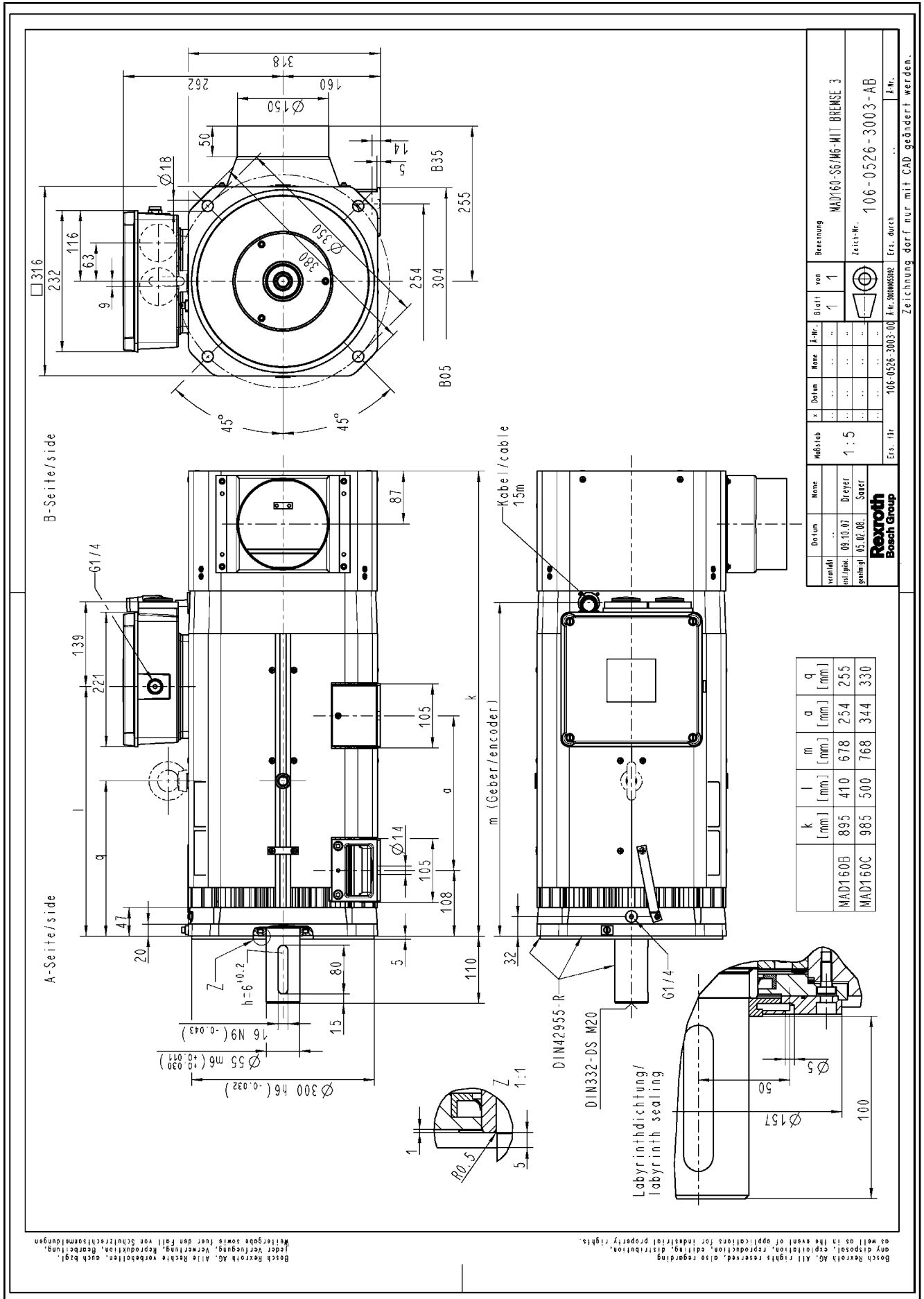

Fig.5-21: MAD160 with M6/S6 encoder, brake 3

Dimension Drawings IndraDyn A

5.4 Frame Size MAD180

5.4.1 MAD180 without Brake

A-Seite/side

B-Seite/side

Geber encoder

320, 266, 35, 85, 50, 287, 180, 15, 279, 350, 364, 45°, 45°, 40, 186, 281, 80, 20, 110, 5, 140, 121, 14.5, 180, 0.085, 60 m6 (+0.011), 300 h6 (-0.032), 7+0.2, Z, DIN2955-R, DIN332-DS M20, 15

k [mm]	l [mm]	m [mm]	a [mm]	q [mm]	s [mm]
MAD180C 979	562	765	430	360	599
MAD180D 1089	672	875	540	415	709

Labyrinthdichtung/ labyrinth sealing

5, 52.5, 185, 130, 6, 1:1, Z

*** Bei Motoren ohne Geber entfällt das Maß "m". Dimension "m" not applicable for motors without encoder.**

Verf. Nr.
Teil-Nr.	18.10.07	Dreyer
geprüft	04.02.06	Sauer

Rexroth Bosch Group

Maßstab 1:5

Blatt 1 von 1

Benennung MAD180-GHNE BREMSE

Zeich-Nr. 106-0408-3003-AB

Ers. für 106-0408-3003-00 k.w. 3000552 Ers. durch ... k.w.

Zeichnung darf nur mit CAD geändert werden.

Bosch Rexroth AG. All rights reserved, also regarding reproduction, editing, distribution, rights. as well as in the event of applications for industrial property rights.

Bosch Rexroth AG. Alle Rechte vorbehalten, auch bzgl. jeder Verlegung, Vervielfältigung, Reproduktion, Bearbeitung, Weitergabe sowie jeder Form von Schutzrechtsverletzungen.

5.4.2 MAD180 with Brake 2 or 5

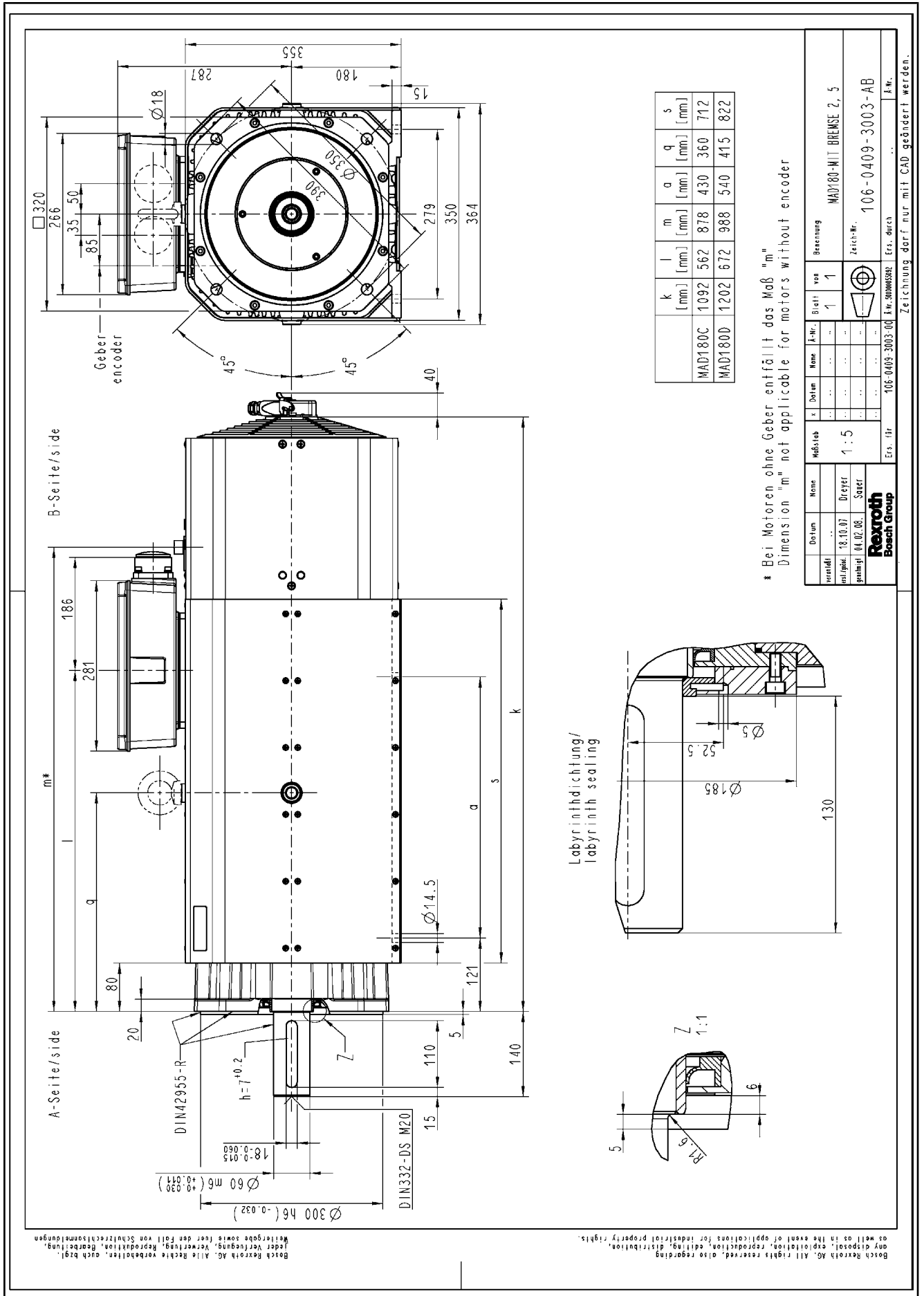

Fig.5-23: MAD180 with brake 2 or 5

Dimension Drawings IndraDyn A

5.4.3 MAD180 with Fan Shroud, without Brake

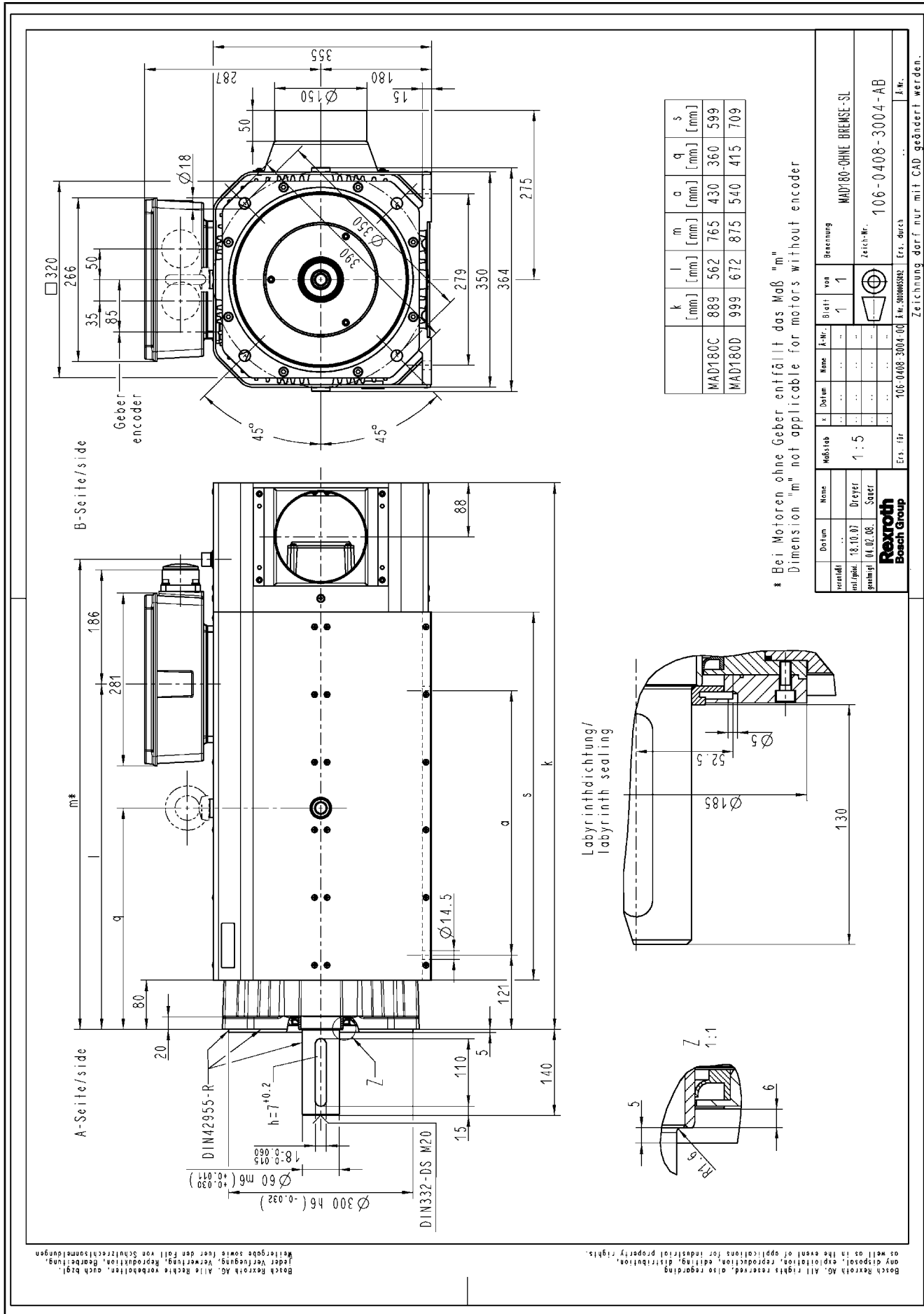

Fig.5-24: MAD180 with SL cooling, without brake

5.4.4 MAD180 with Fan Shroud, Brake 2 or 5

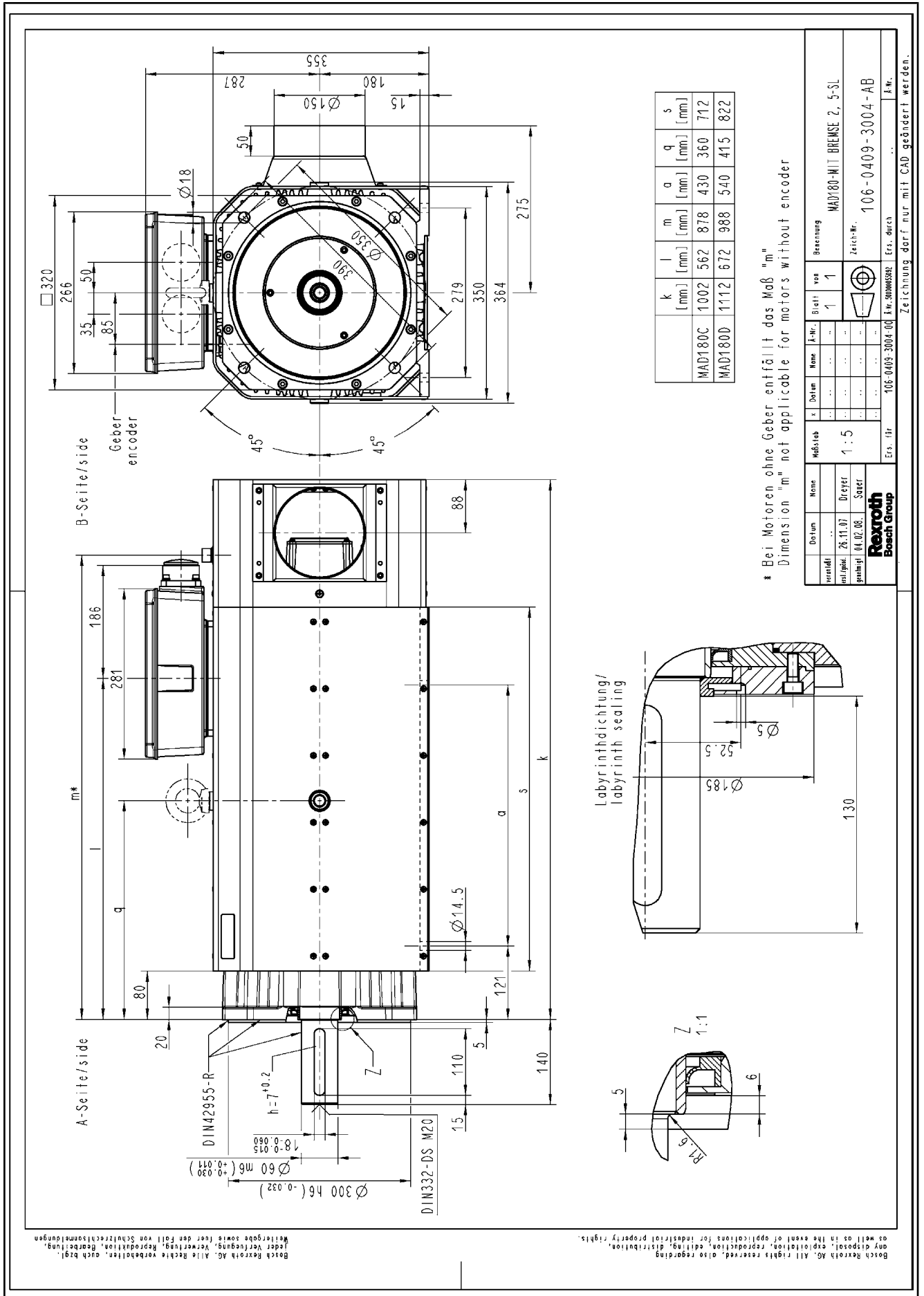

Fig.5-25: MAD180 with SL cooling, brake 2/5

Dimension Drawings IndraDyn A

5.4.5 MAD180 in Ex-type Design with M6 or S6 Encoder, without Brake

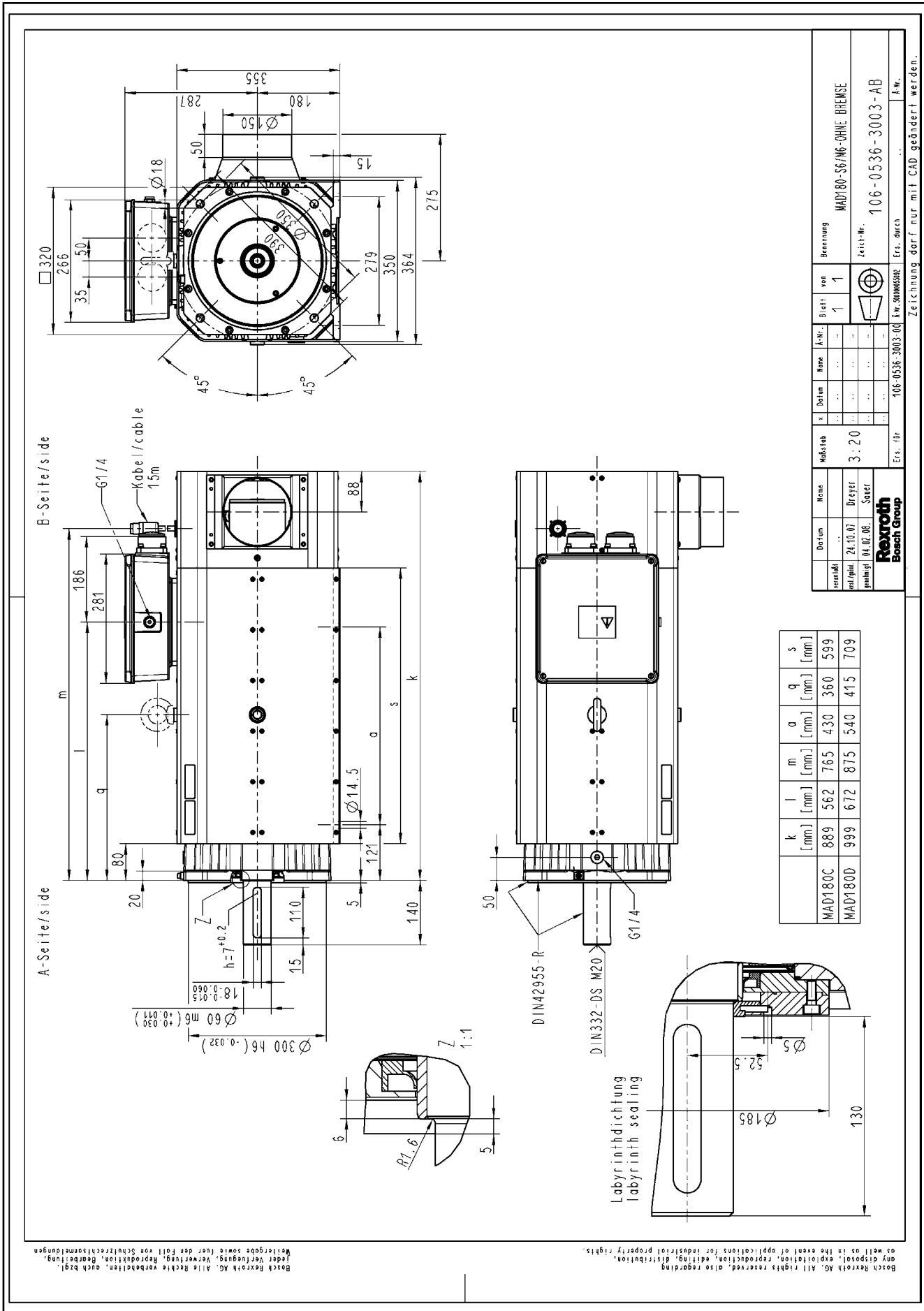

Fig.5-26: MAD180 with M6/S6 encoder, without brake

5.4.6 MAD180 in Ex-type Design with M6 or S6 Encoder, Brake 2 or 5

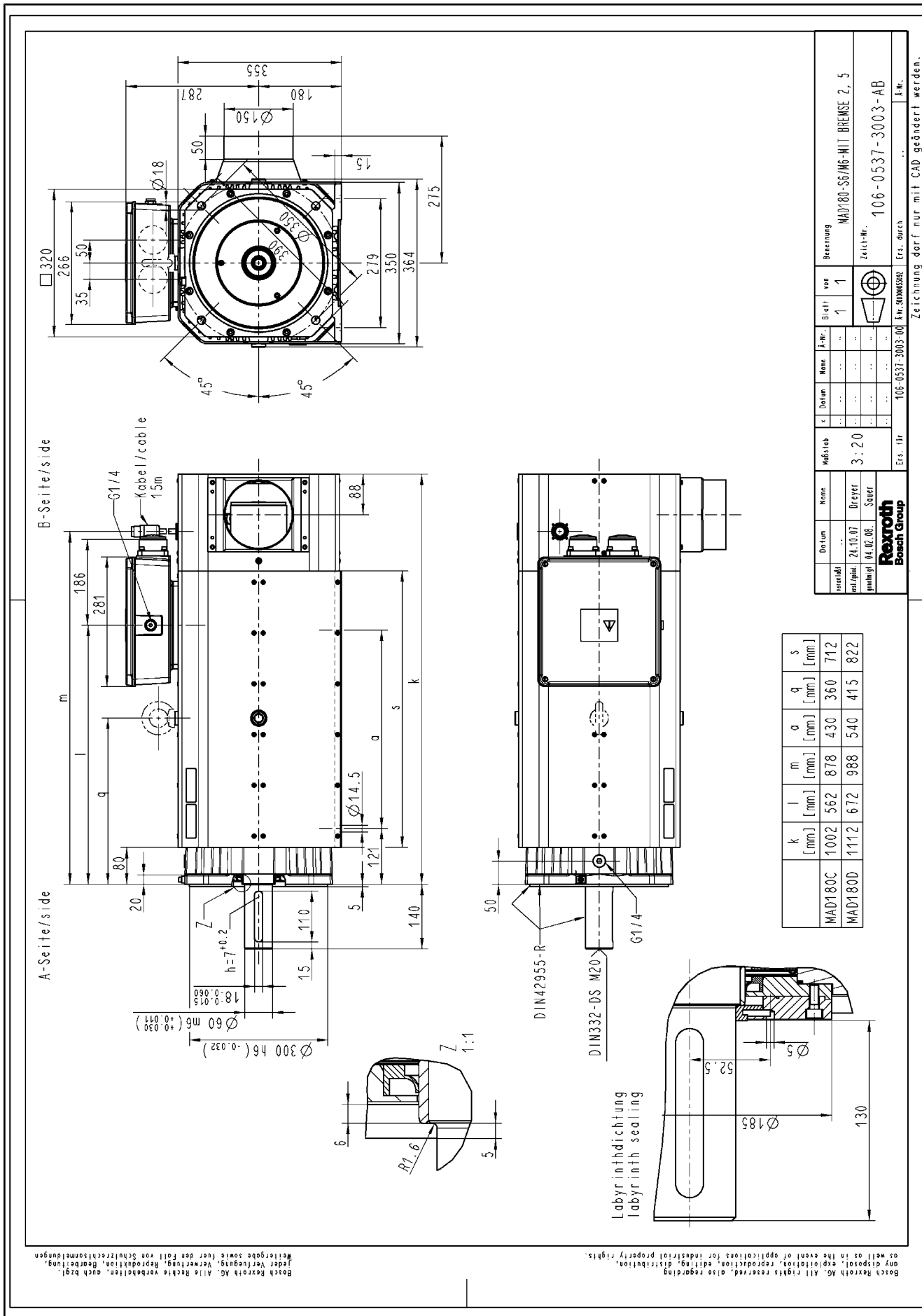
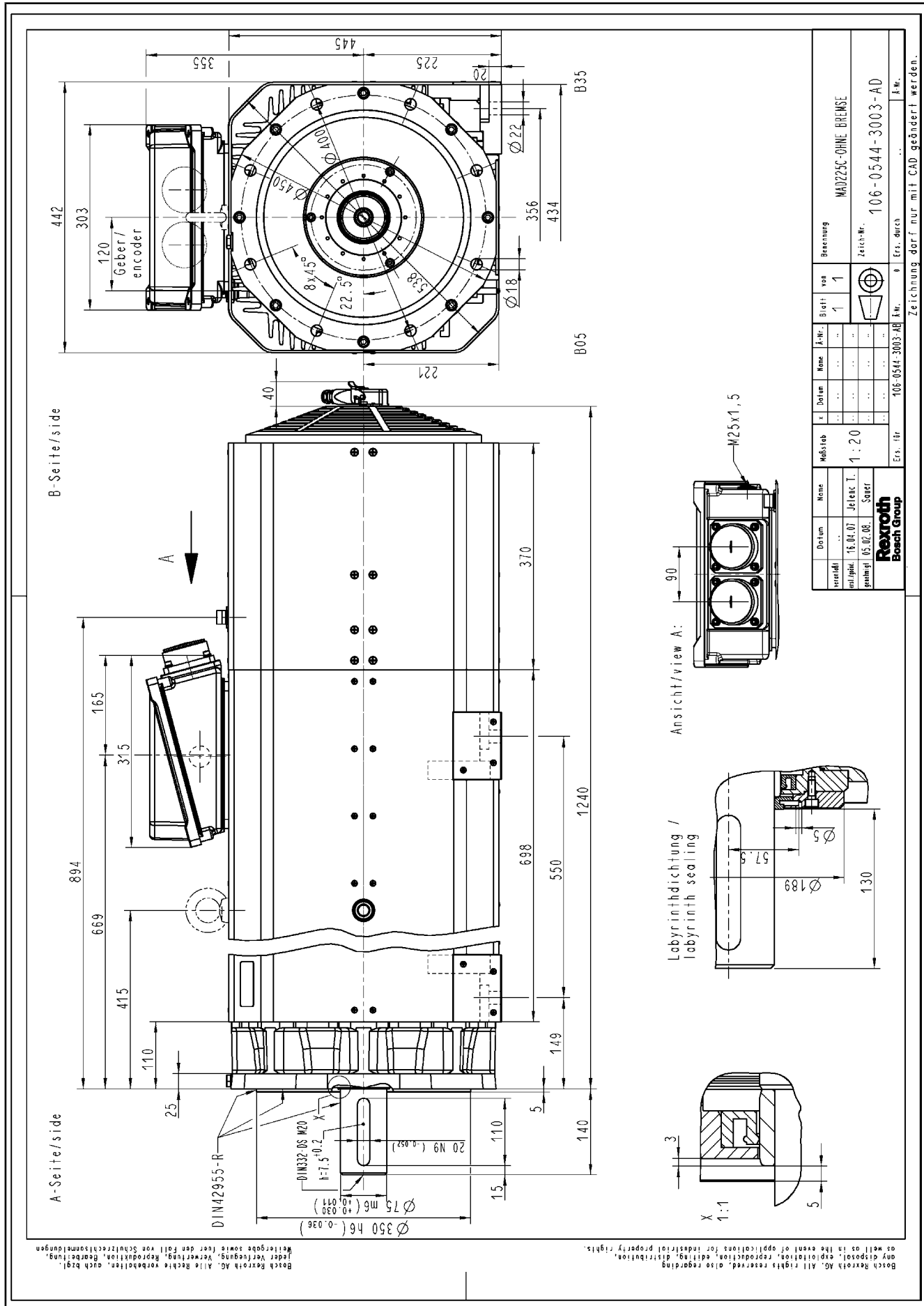

Fig.5-27: MAD180 with M6/S6 encoder, brake 2/5

Dimension Drawings IndraDyn A

5.5 Frame Size MAD225

5.5.1 MAD225 without Brake



5.5.2 MAD225 with Fan Shroud, without Brake

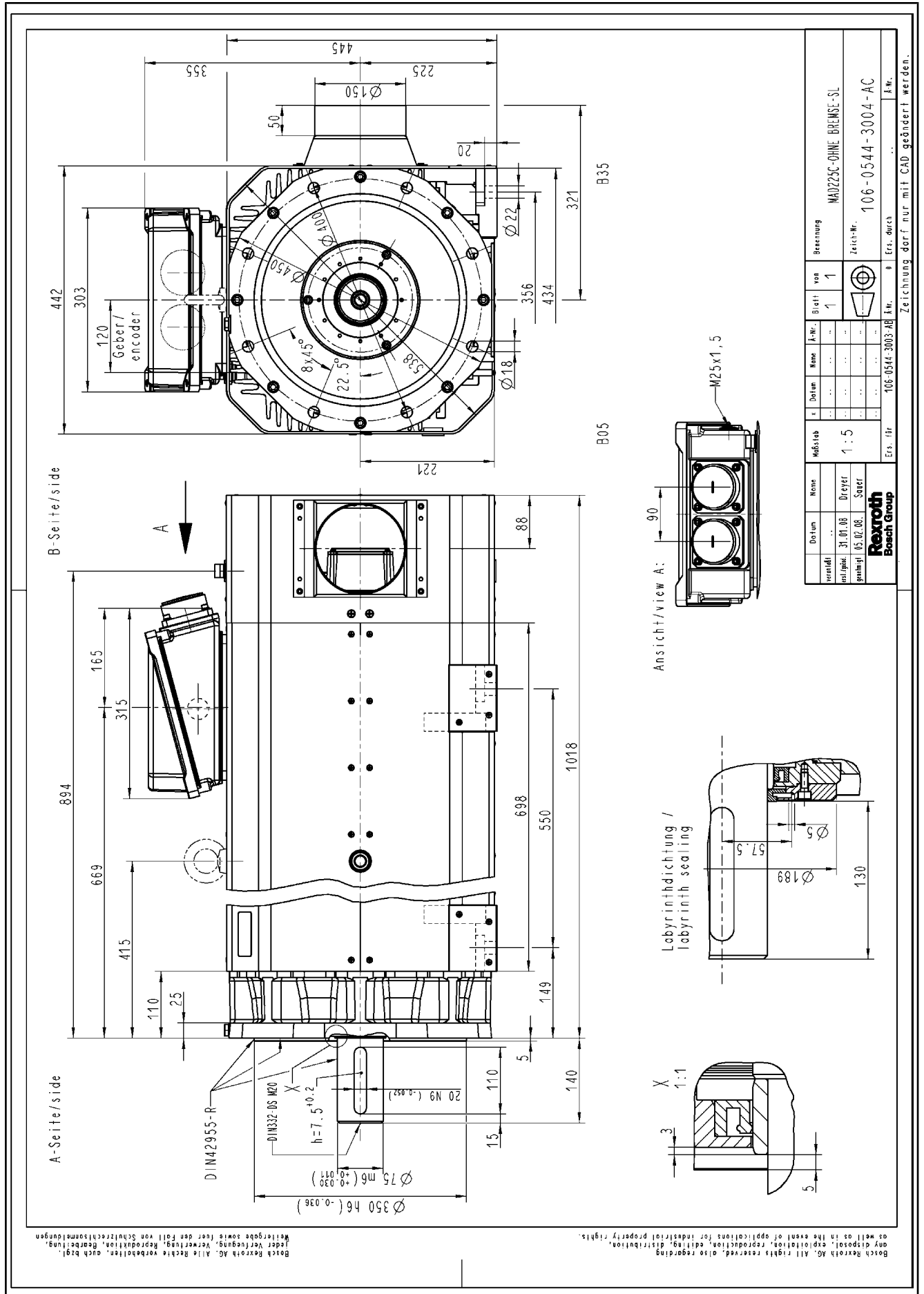

Fig.5-29: MAD225 with SL cooling, without brake

Dimension Drawings IndraDyn A

5.5.3 MAD225 in Ex-type Design, M6 or S6 Encoder, without Brake

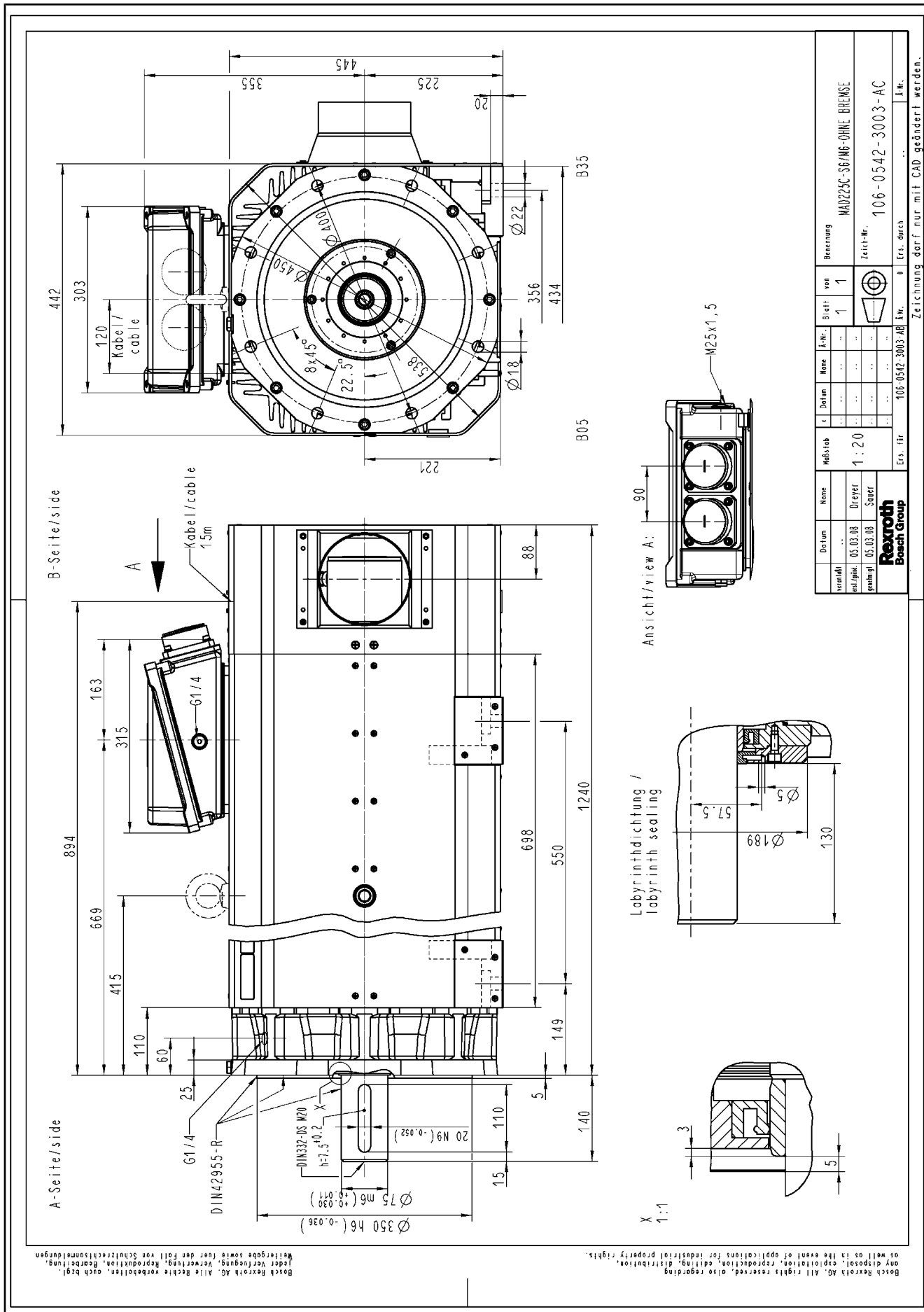
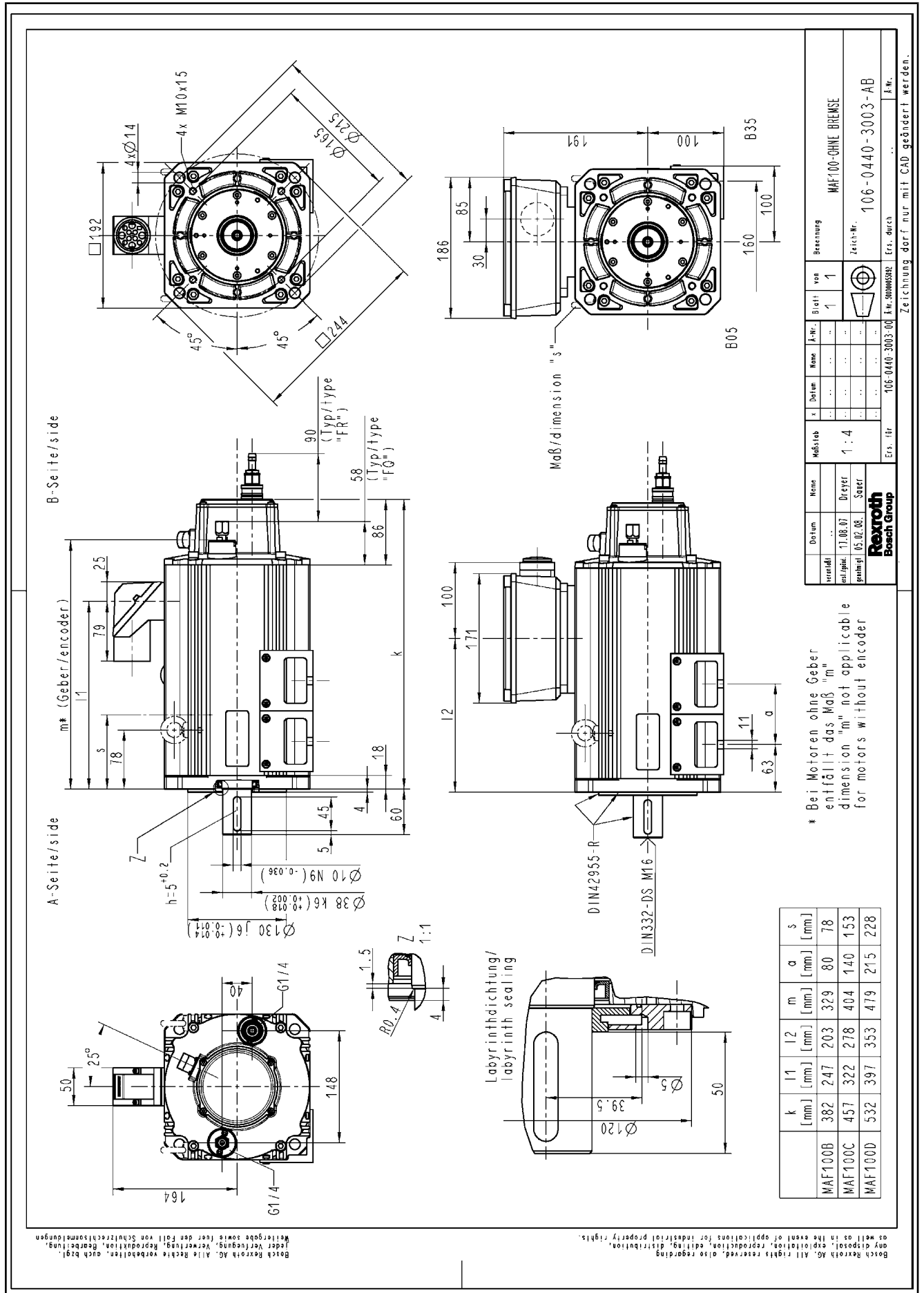

Fig.5-30: MAD225 with M6/S6 encoder, without brake

5.6 Frame Size MAF100

5.6.1 MAF100 without Brake



Dimension Drawings IndraDyn A

5.6.2 MAF100 with Brake 1 or 5

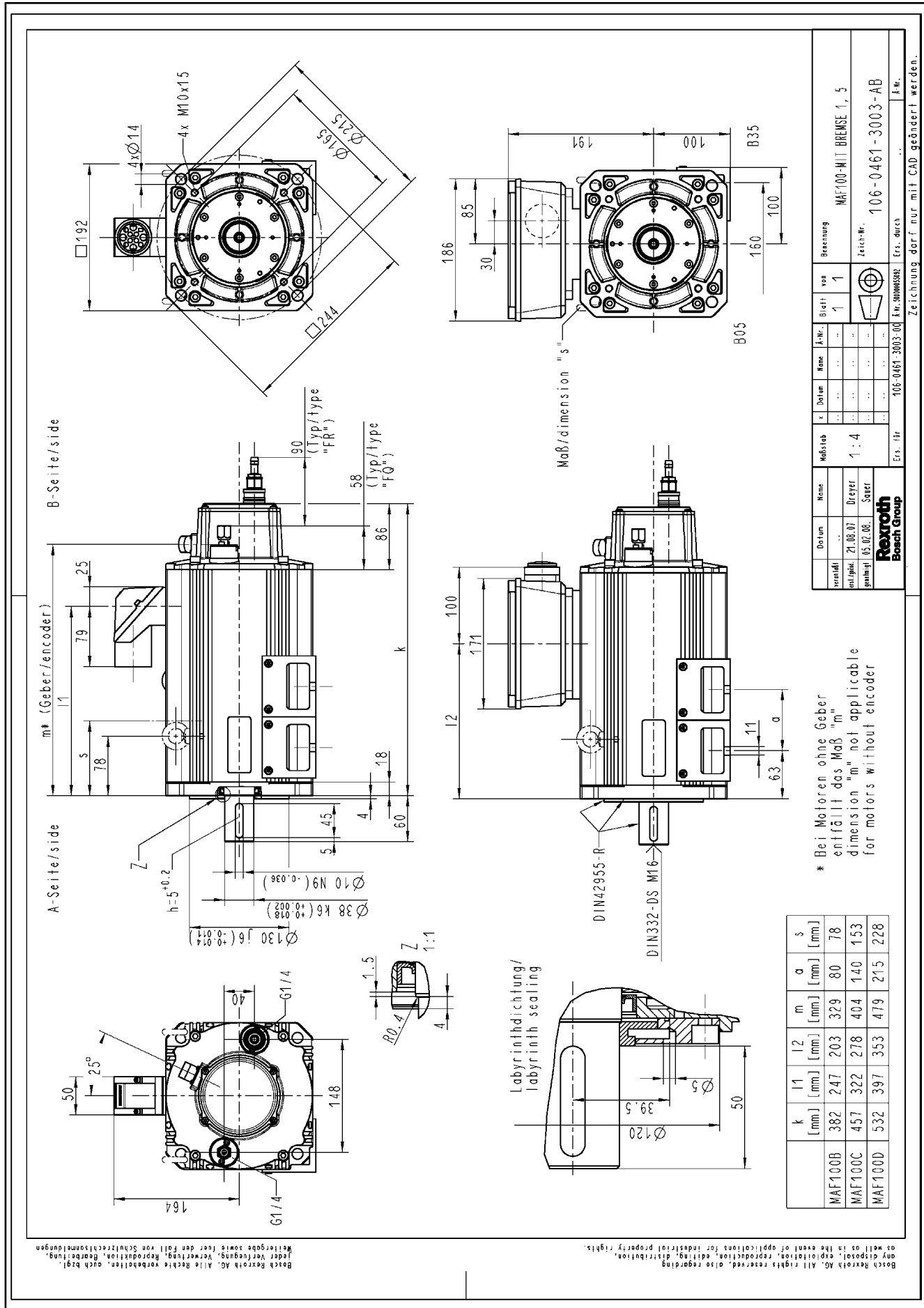

Fig. 5-32: MAF100 with brake 1 or 5

5.6.3 MAF100 in Ex-type Design with M6 or S6 Encoder, without Brake

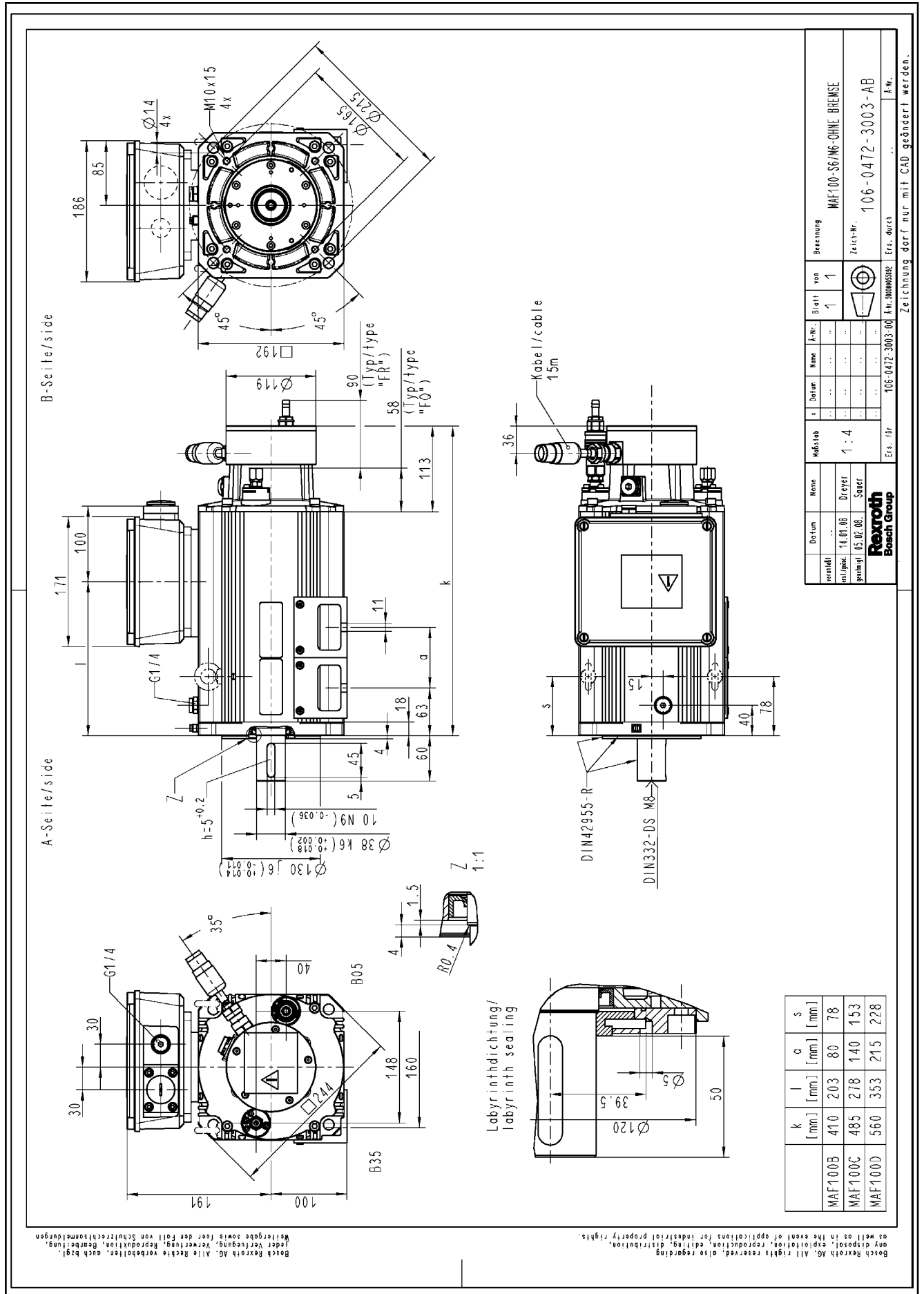

Fig.5-33: MAF100 with M6/S6 encoder, without brake

Dimension Drawings IndraDyn A

5.6.4 MAF100 in Ex-type Design with M6 or S6 Encoder, Brake 1 or 5

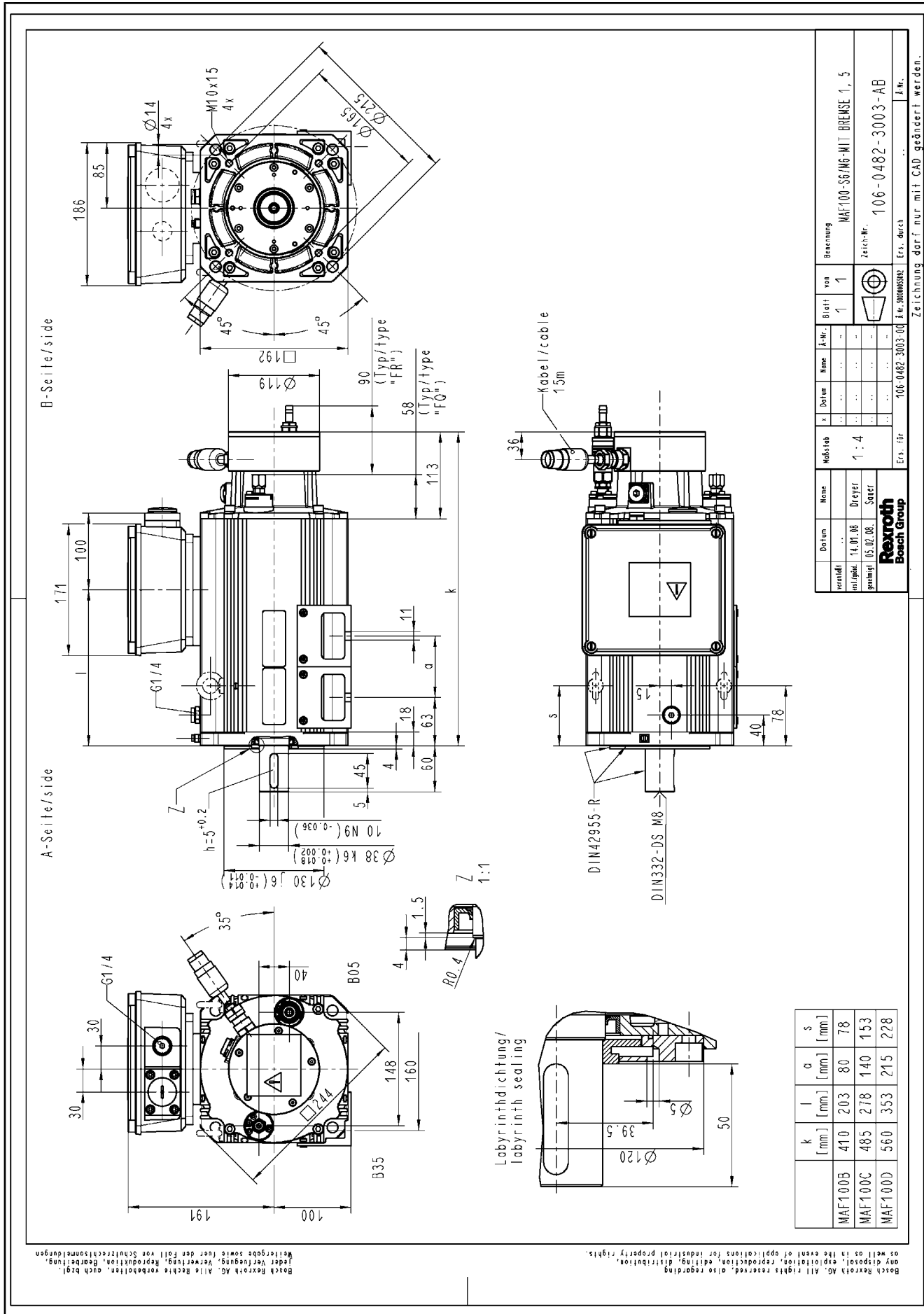

Fig.5-34: MAF100 with M6/S6 encoder, brake 1/5

5.7 Frame Size MAF130

5.7.1 MAF130 without Brake

A-Seite/side

B-Seite/side

Top View

Bottom View

Detail: Labyrinthdichtung/labyrinth sealing

Detail: Shaft

Table of Dimensions:

	k	l1	l2	m	a	q	s
MAF130B	413	265	222	388	135	105	205
MAF130C	483	335	292	458	205	155	230
MAF130D	613	465	422	588	335	240	275
MAF130E	693	545	502	668	415	305	305

Technical Specifications:

- Shaft: DIN42955-R
- Mounting: DIN332-DS M16
- Sealing: Labyrinthdichtung/labyrinth sealing
- Flange: G1/4
- Mounting holes: 4x Ø18
- Mounting holes: 4x Ø300
- Mounting holes: 4x Ø335

Notes:

- * Bei Motoren ohne Geber entfällt das Maß "m". Dimension "m" not applicable for motors without encoder.
- Bei Motoren ohne Geber entfällt das Maß "m". Dimension "m" not applicable for motors without encoder.

Revision Table:

Veränd.	Datum	Name	Messstab	x	Datum	Name	A-Nr.	Blatt	von	Bezeichnung
1	03.06.07	Dreyer	1:5	1	1			1	1	MAF130-OHNE BREMSE
2	05.02.08	Sauer								106-0406-3003-AC

Footer:

Bosch Rexroth AG. All rights reserved, also regarding reproduction, editing, distribution, etc. as well as in the event of applications for industrial property rights.

Bosch Rexroth AG. Alle Rechte vorbehalten, auch bzgl. jeder Vervielfältigung, Verbreitung, Verwertung, Reproduktion, Bearbeitung, Weitergabe sowie über den Fall von Schutzrechtsverletzungen.

Zeichnung darf nur mit CAD geändert werden.

Dimension Drawings IndraDyn A

5.7.2 MAF130 with Brake 1 or 5

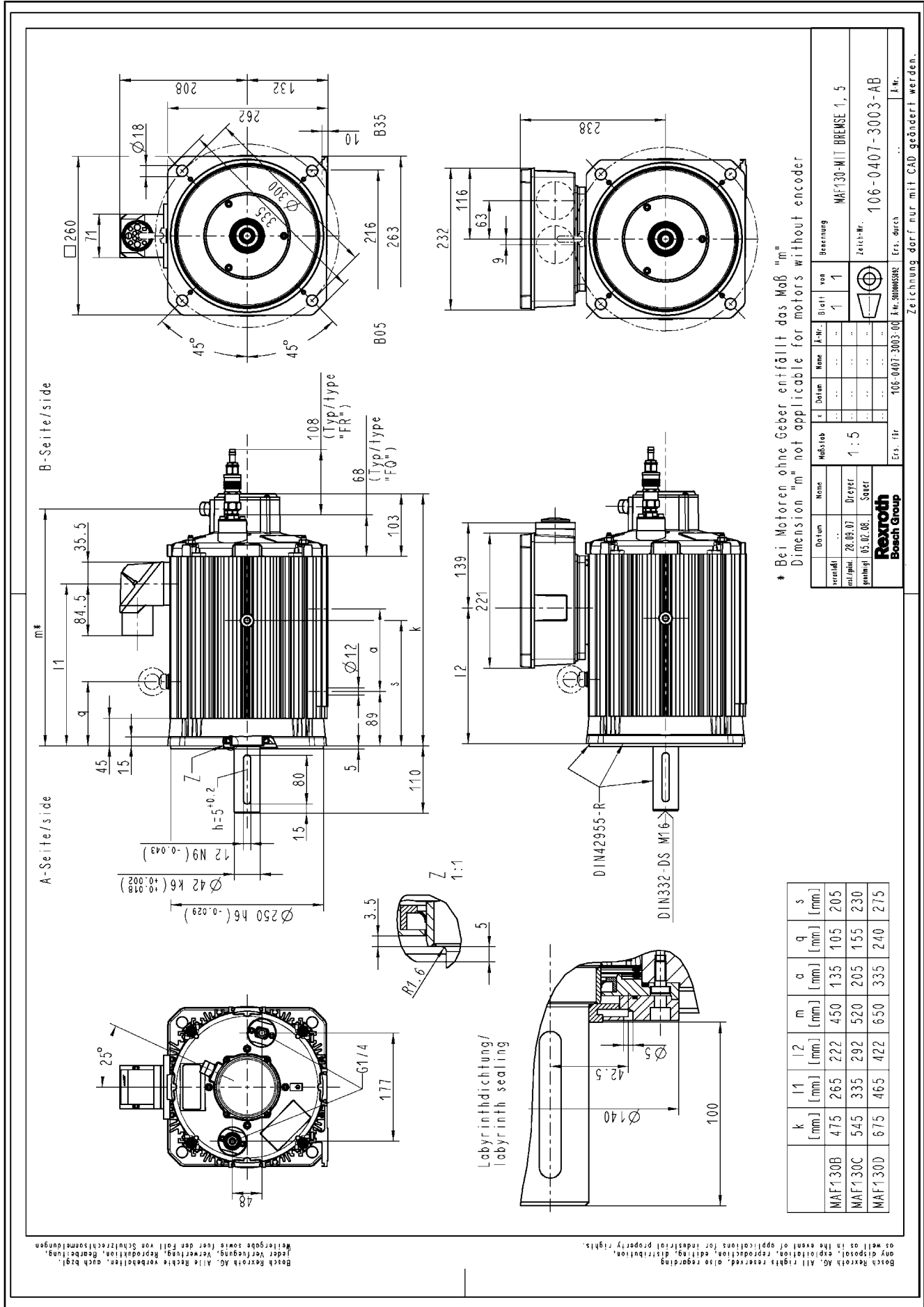

* Bei Motoren ohne Geber entfällt das Maß "m"
Dimension "m" not applicable for motors without encoder

Zeichnung darf nur mit CAD geändert werden.

Revised by: 28.09.07 Dreier
drawing of: 05.02.06 Sauer

Scale: 1:5

Design: 106-0407-3003-00

Part: k.w., DIMENSER, Ers. durch k.w.

Material: 106-0407-3003-00

Quantity: 1

Revision: 1

Name: k.w.

Blatt: 1

von: 1

Benennung: MAF130-MIT BREMSE 1, 5

Zeich.-Nr.: 106-0407-3003-AB

Rexroth
Bosch Group

Fig.5-36: MAF130 with brake 1 or 5

5.7.3 MAF130 in Ex-type Design with M6 or S6 Encoder, without Brake

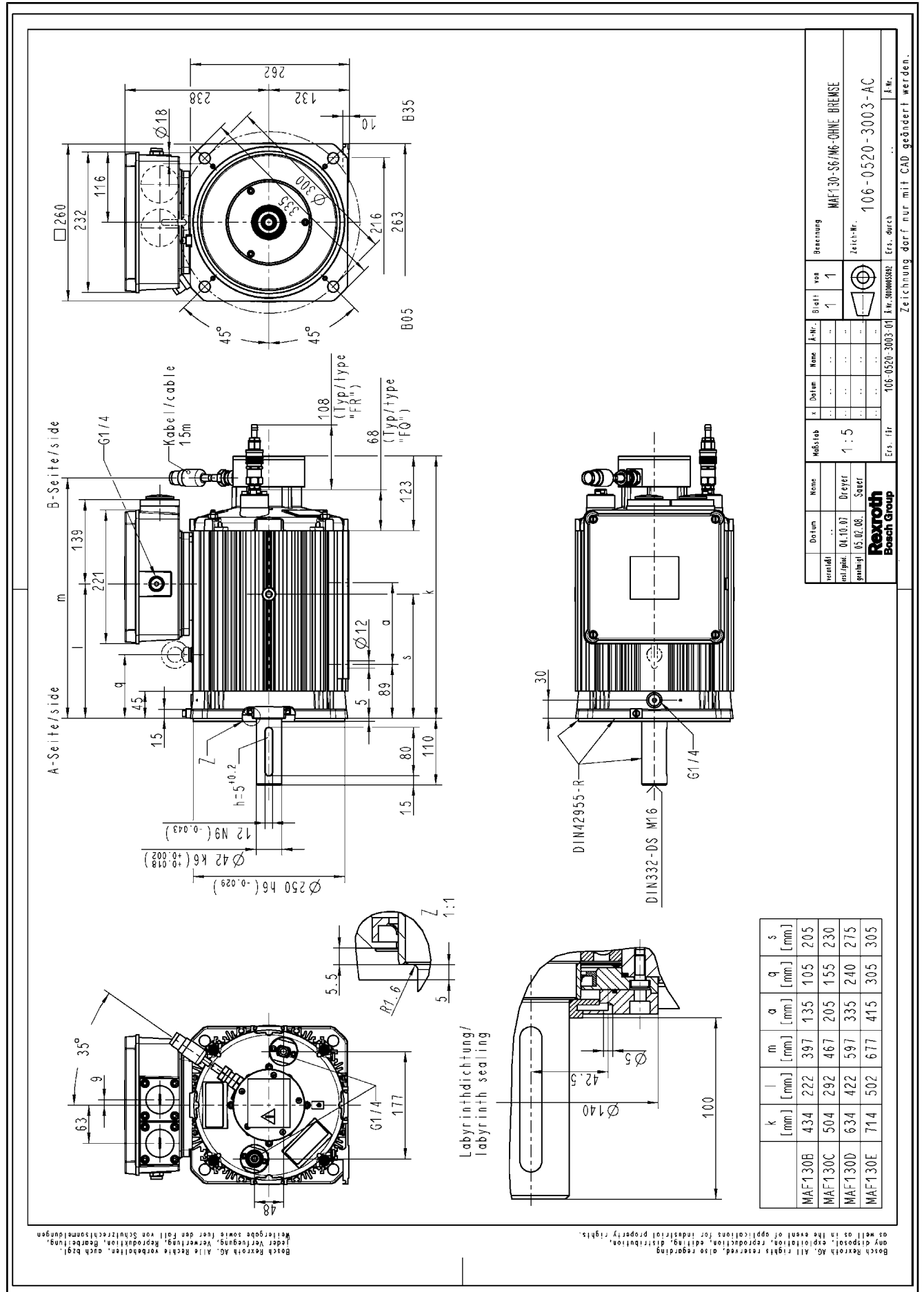

Fig.5-37: MAF130 with M6/S6 encoder, without brake

Dimension Drawings IndraDyn A

5.7.4 MAF130 in Ex-type Design with M6 or S6 Encoder, Brake 1 or 5

Technical drawing of the MAF130 motor with M6 or S6 encoder and brake. The drawing includes three main views: a detailed front view (A-Seite/side), a detailed back view (B-Seite/side), and a top view. Dimensions are provided in millimeters. Key features include a cable (Kabel/cable) with a length of 1.5m, a shaft diameter of $\phi 12$, and various mounting dimensions. The top view shows a circular motor body with a diameter of $\phi 300$ and a mounting flange diameter of $\phi 335$. The drawing also includes a section view of the labyrinth sealing (Labyrinthdichtung/labyrinth sealing) and a table of dimensions for different motor variants.

Veränd.	Datum	Name	Maßstab	x	Datum	Mane	A-Nr.	Blatt	von	Bezeichnung
rel./geprüft	04.10.07	Dreyer	1:5	1	1	MAF130-S6/16-MIT BREMSE 1, 5
gezeichnet	05.02.06	Sauer				Zeich.-Nr. 106-0521-3003-AB
Ers. für 106-0521-3003-00 k.w./nummer Ers. durch k.w.										

	k	l	m	a	q	s
MAF130B	496	222	459	135	105	205
MAF130C	544	292	529	205	155	230
MAF130D	696	422	659	335	240	275

Zeichnung darf nur mit CAD geändert werden.

Rexroth
Bosch Group

Bosch Rexroth AG. Alle Rechte vorbehalten, auch bzgl. jeder Vervielfältigung, Verbreitung, Reproduktion, Bearbeitung, Weitergabe sowie ihrer der Fall von Schutzrechtsmaßnahmen.

Bosch Rexroth AG. All rights reserved, also regarding any disposal, exploitation, reproduction, editing, distribution, rights as well as in the event of applications for industrial property rights.

Fig.5-38: MAF130 with M6/S6 encoder, brake 1/5

5.8 Frame Size MAF160

5.8.1 MAF160 without Brake

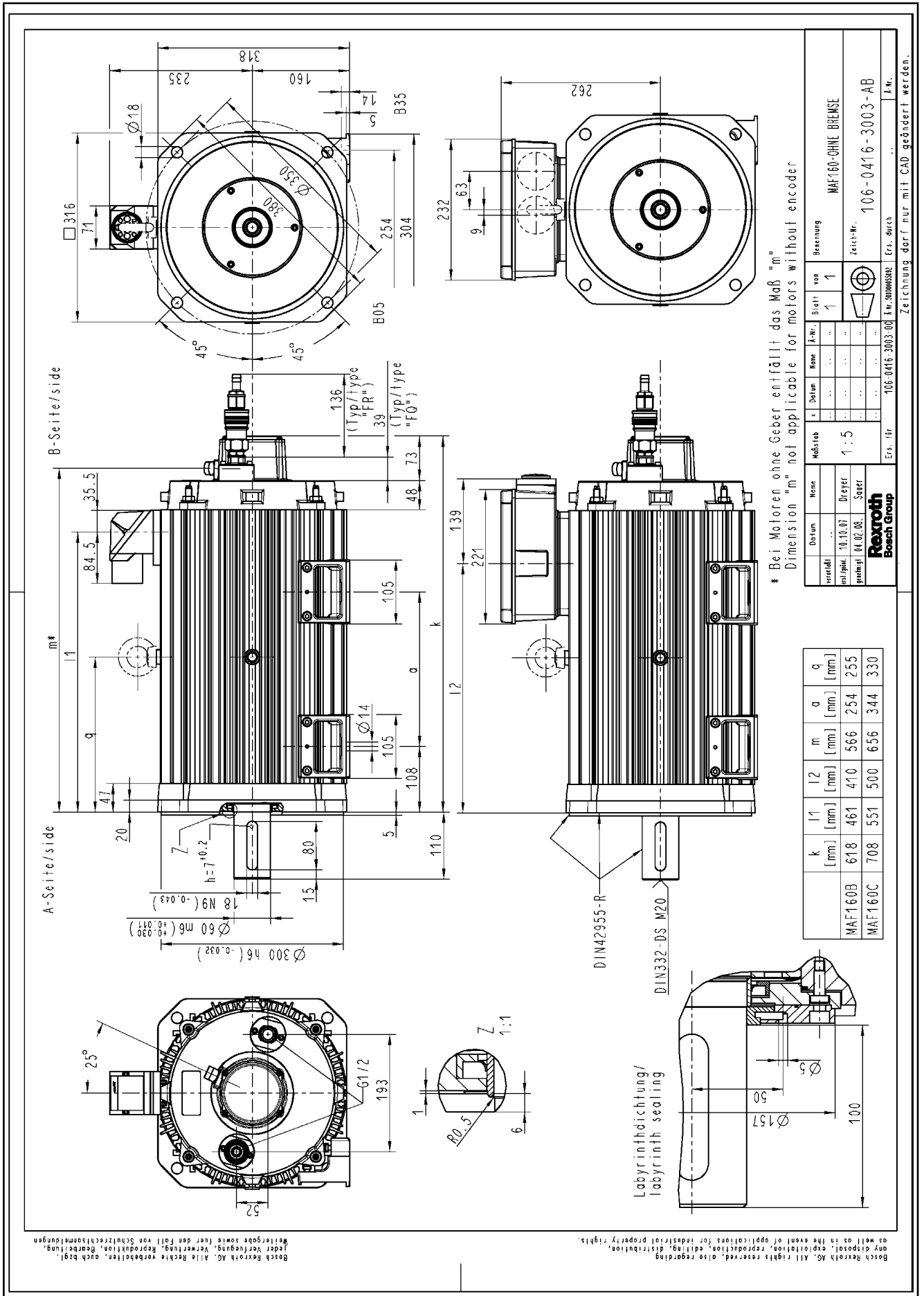

Dimension Drawings IndraDyn A

5.8.2 MAF160 with Brake 1 or 5

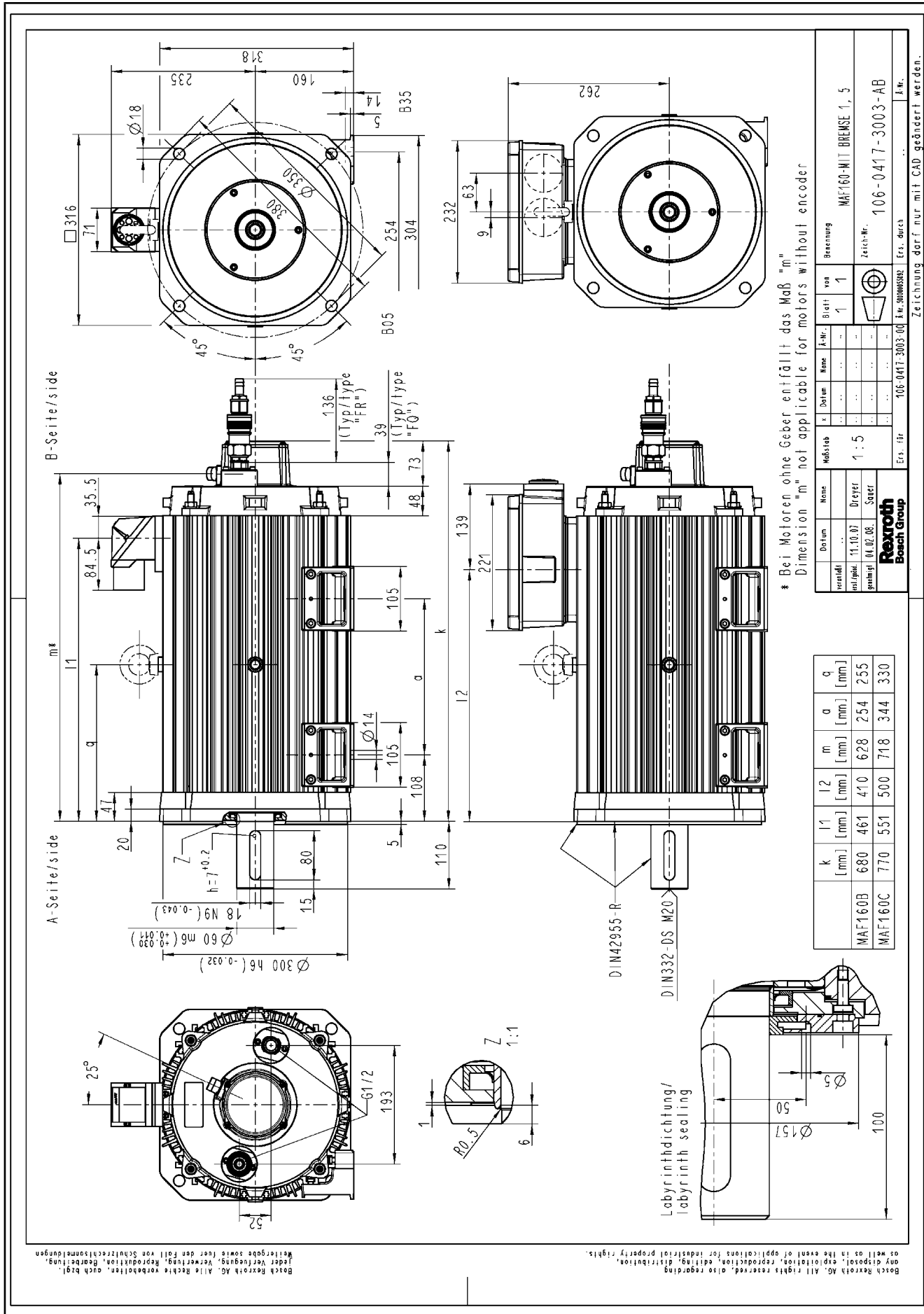

Fig.5-40: MAF160 with brake 1 or 5

5.8.3 MAF160 in Ex-type Design with M6 or S6 Encoder, without Brake

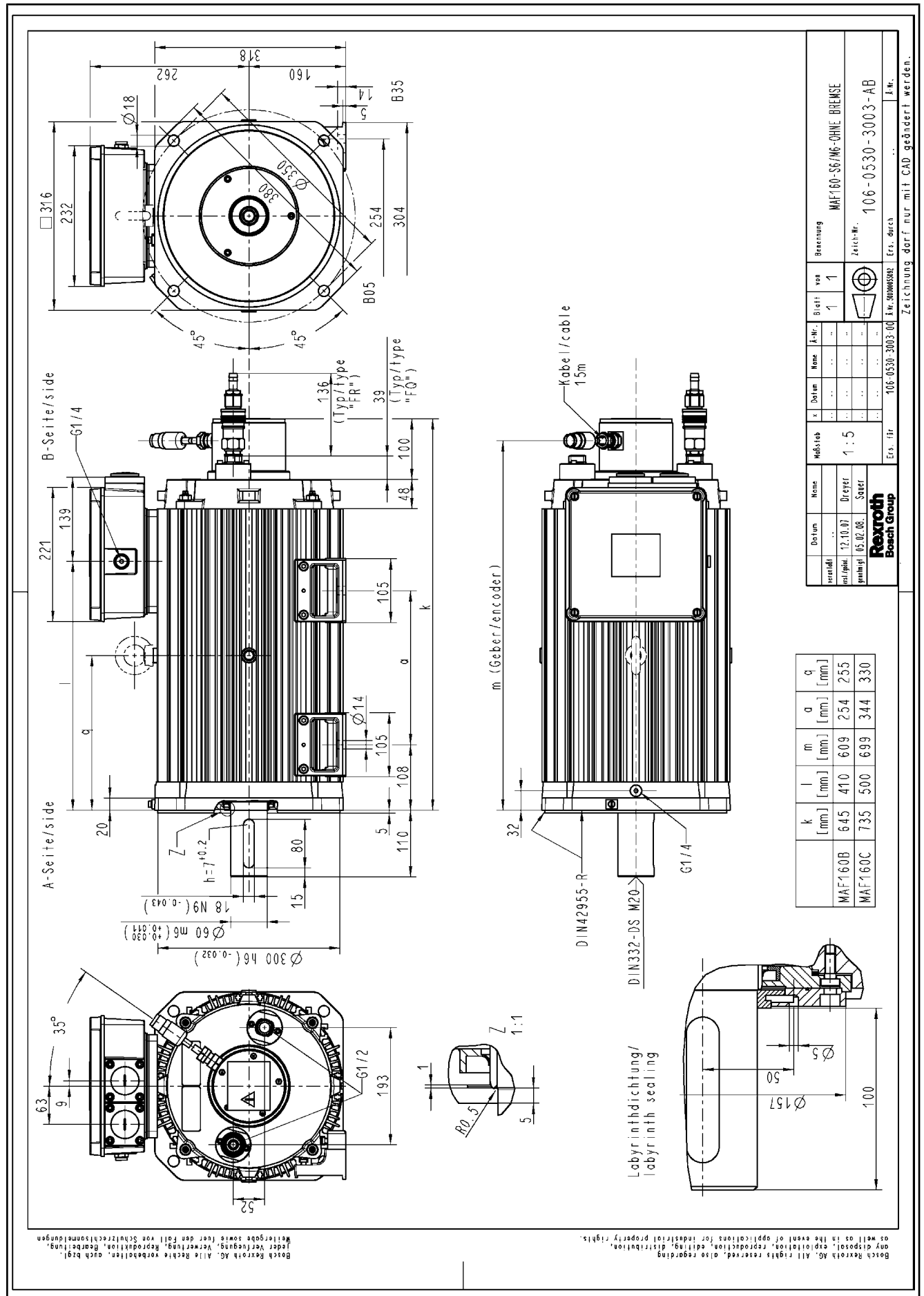

Fig.5-41: MAF160 with M6/S6 encoder, without brake

Dimension Drawings IndraDyn A

5.8.4 MAF160 in Ex-type Design with M6 or S6 Encoder, Brake 1 or 5

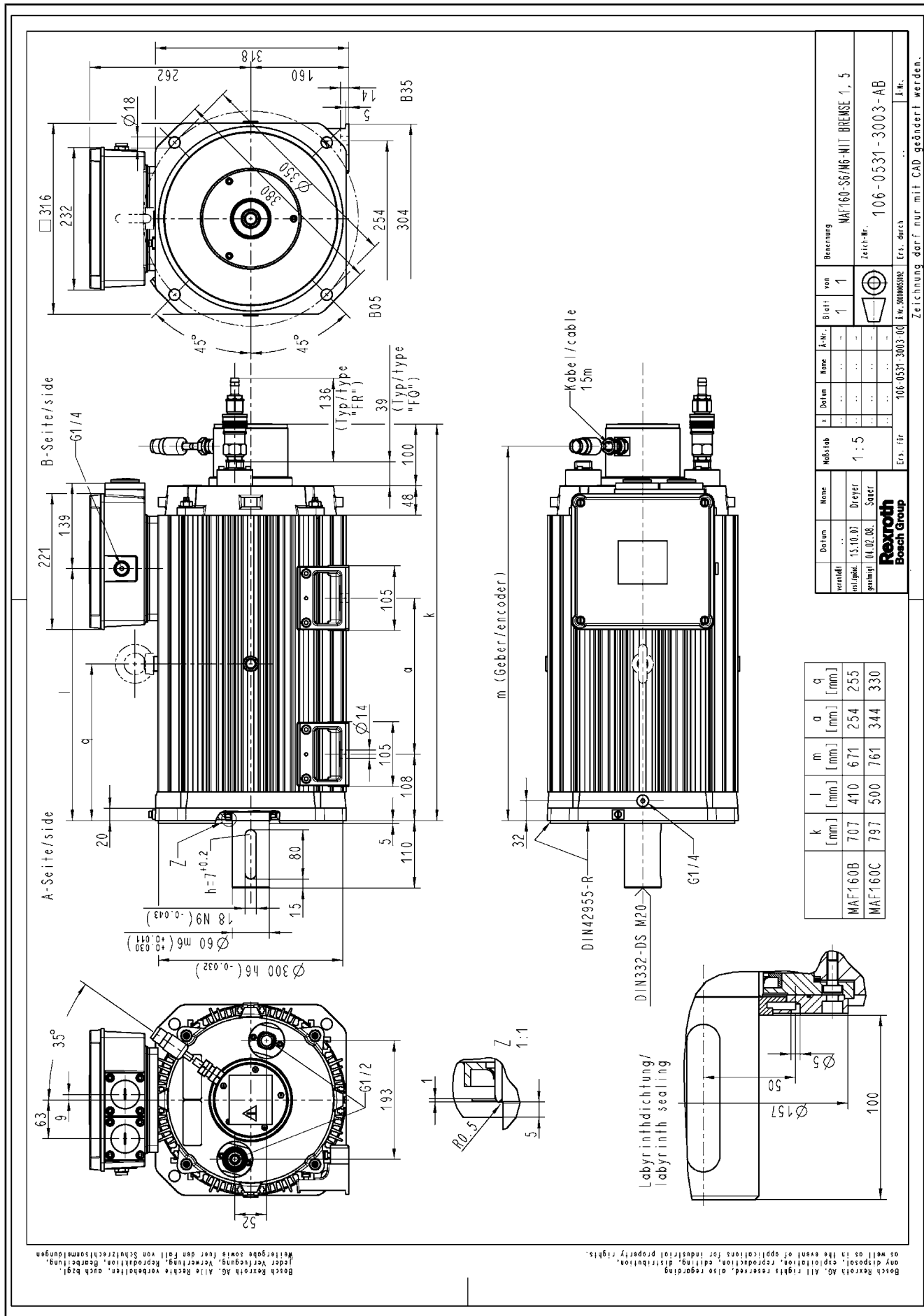

Fig.5-42: MAF160 with M6/S6 encoder, brake 1/5

5.9 Frame Size MAF180

5.9.1 Threaded Holes in MAF180 Motor Housing

The MAF180 is provided with M5 threaded holes centrally along the longitudinal sides on the motor housing profile. After having mounted the motor, the user can use these threaded holes as required.

However, there are the following restrictions:

- The maximum allowed screw-in depth is 10 mm.
- The maximum allowed tightening torque is 5.5...6 Nm (with a screw-in depth of 8–10 mm and screws of property class 8.8).

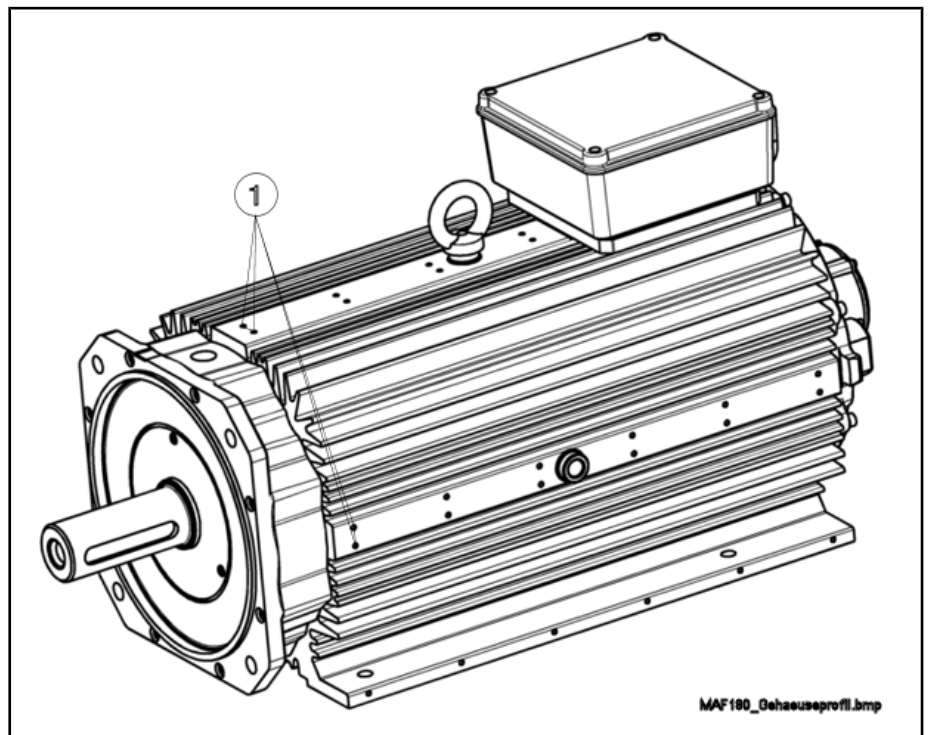

① M5 threaded holes

Fig. 5-43: Threaded holes in MAF180 motor housing

Dimension Drawings IndraDyn A

5.9.2 MAF180 without Brake

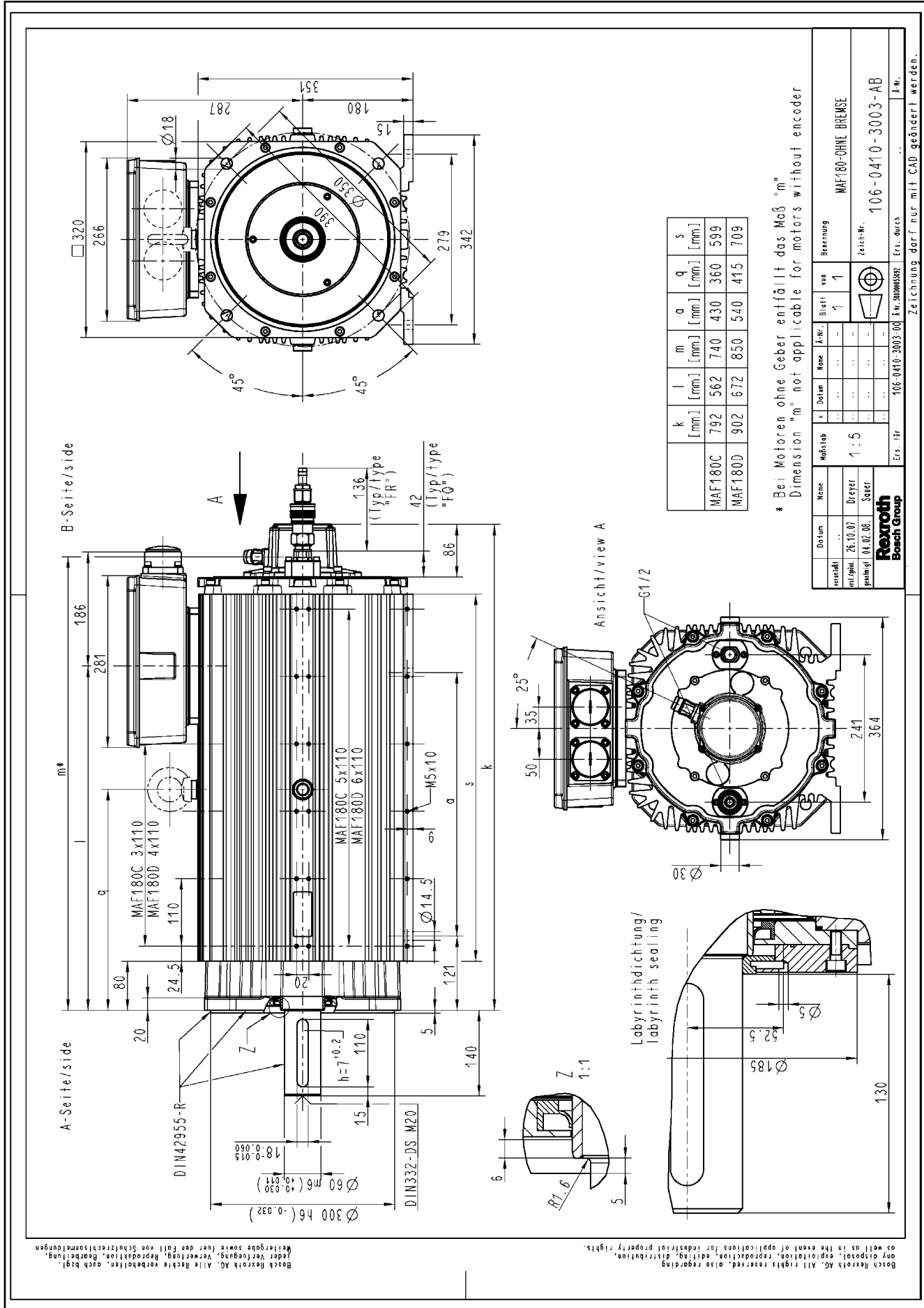

Fig.5-44: MAF180 without brake

5.9.3 MAF180 with Brake 2 or 5

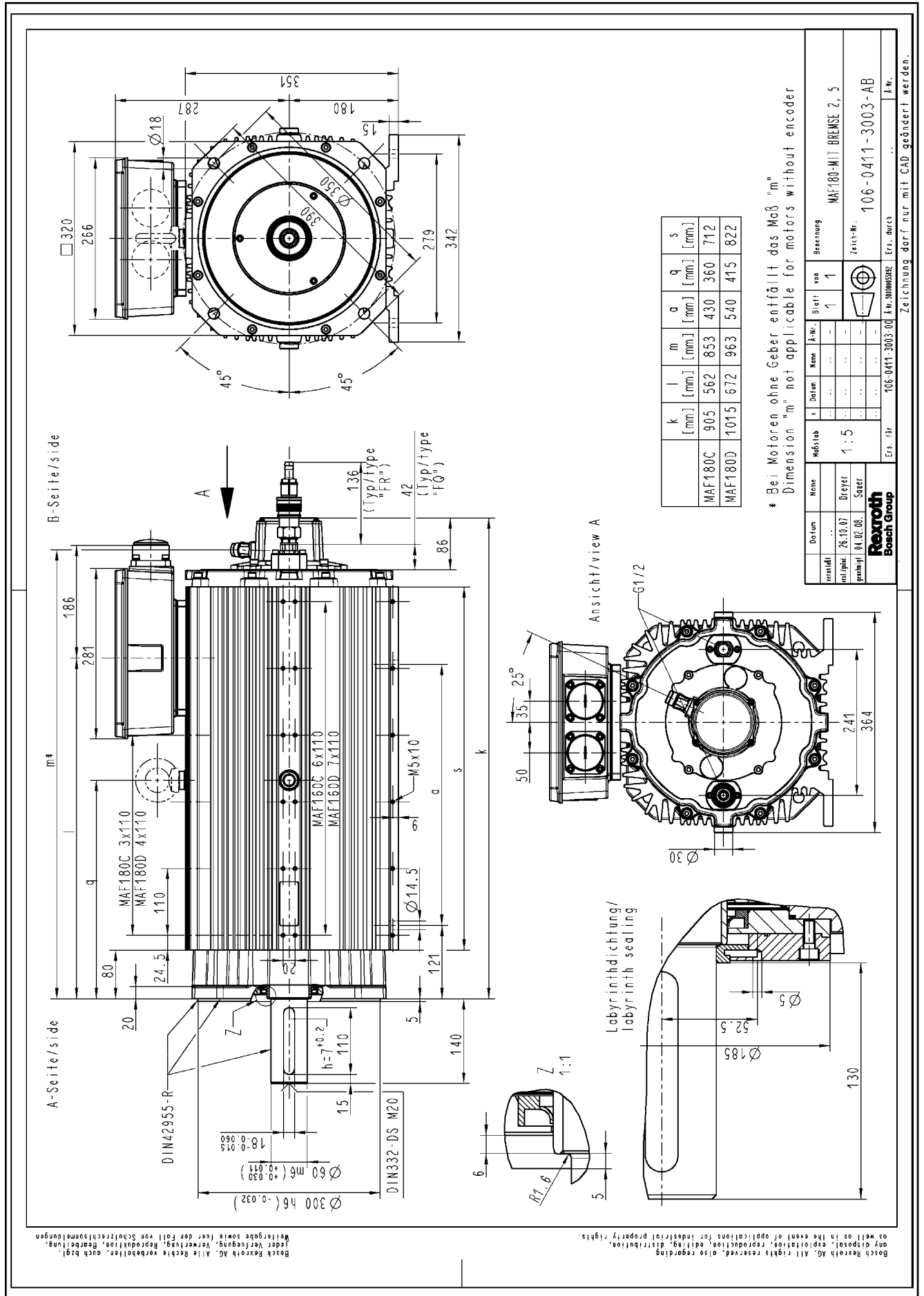

Fig.5-45: MAF180 with brake 2 or 5

Dimension Drawings IndraDyn A

5.9.4 MAF180 in Ex-type Design with M6 or S6 Encoder, without Brake

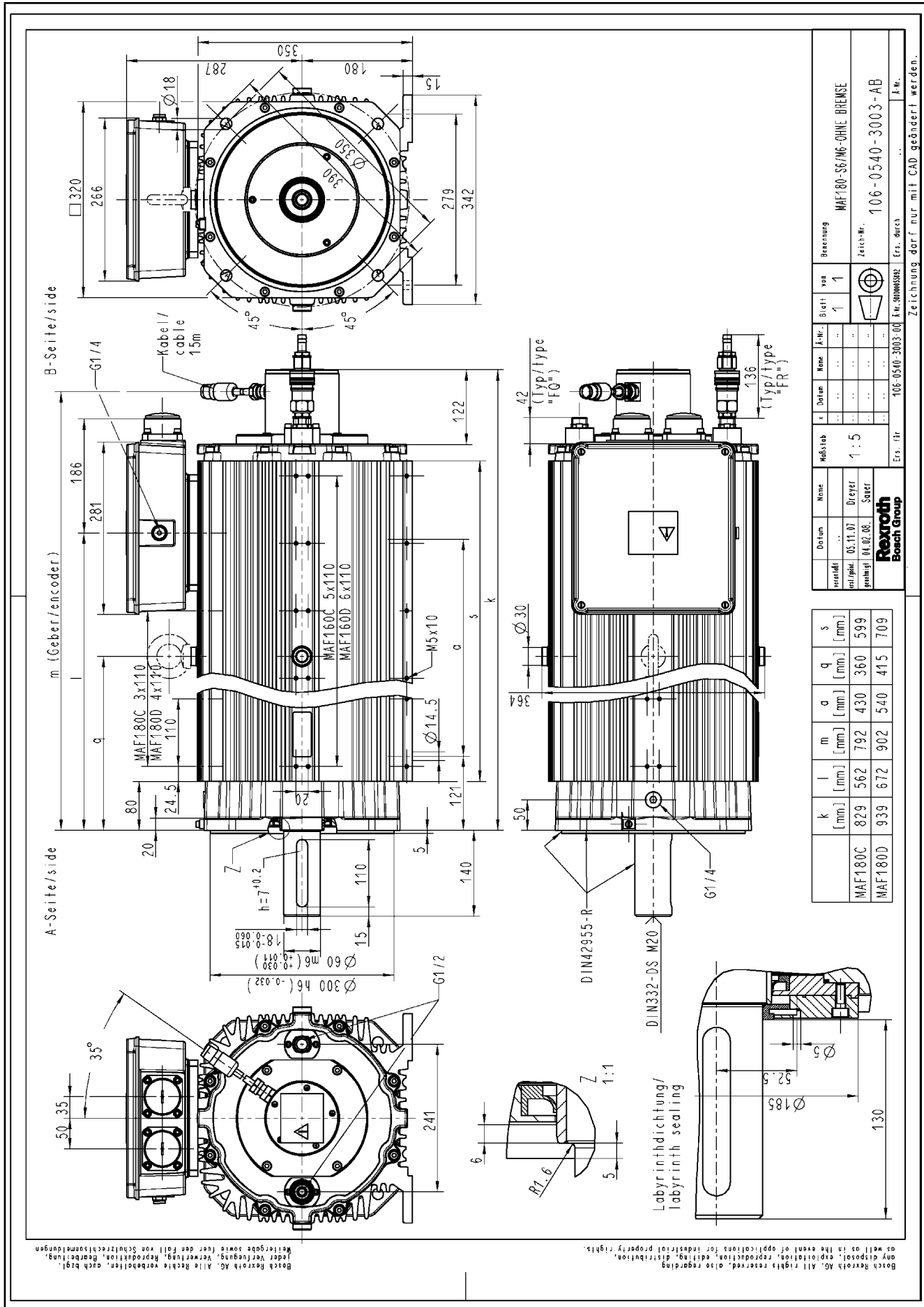

Fig.5-46: MAF180 with M6/S6 encoder, without brake

5.9.5 MAF180 in Ex-type Design with M6 or S6 Encoder, Brake 2 or 5

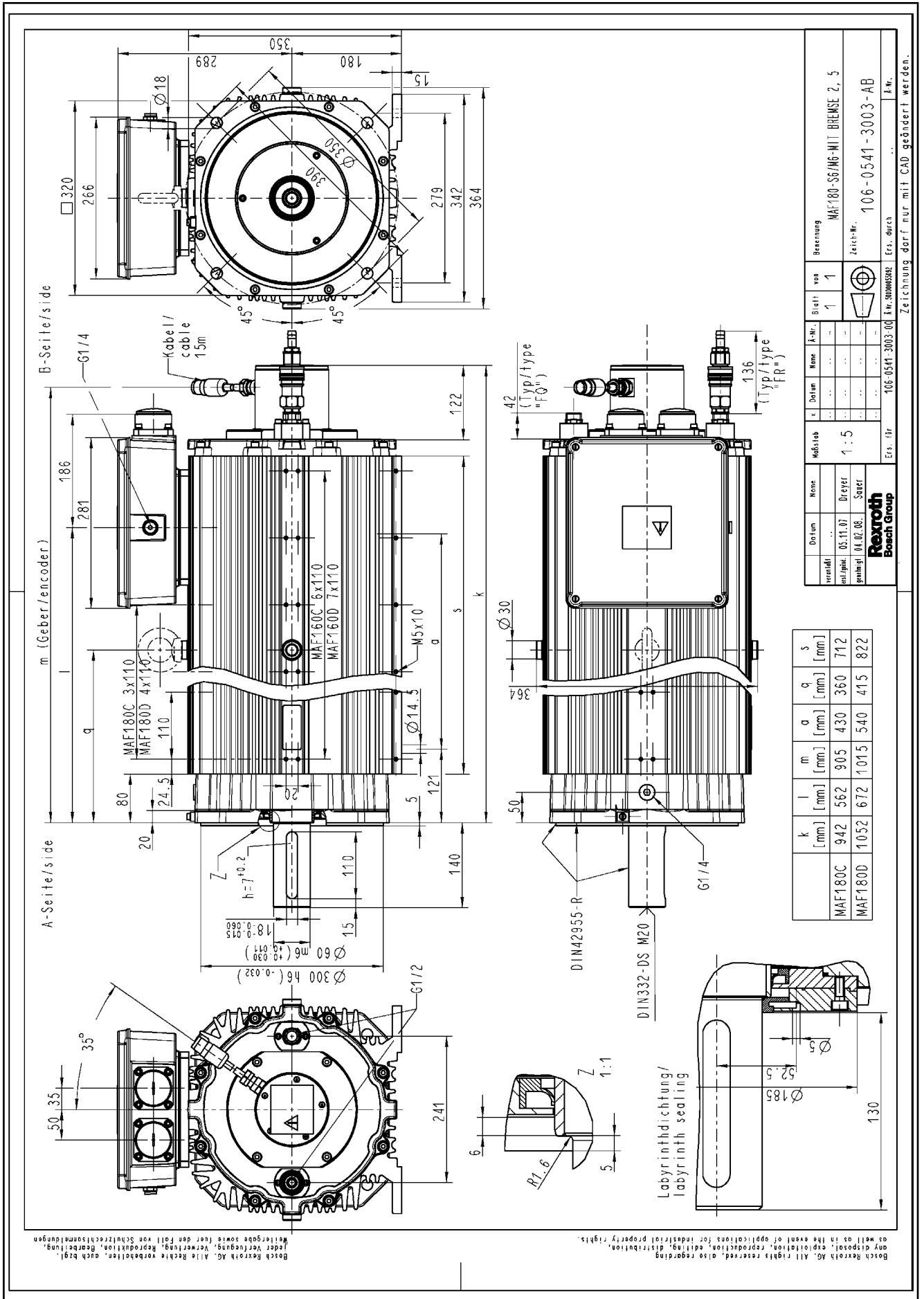

Fig.5-47: MAF180 with M6/S6 encoder, brake 2/5

Dimension Drawings IndraDyn A

5.10 Frame Size MAF225

5.10.1 Threaded Holes in MAF225 Motor Housing

As is the case with the MAF180, the MAF225 is also provided with M5 threaded holes centrally along the longitudinal sides on the motor housing profile. After having mounted the motor, the user can use these threaded holes as required.

However, there are the restrictions described in [chapter 5.9.1 "Threaded Holes in MAF180 Motor Housing"](#) on page 169.

5.10.2 MAF225C without Brake

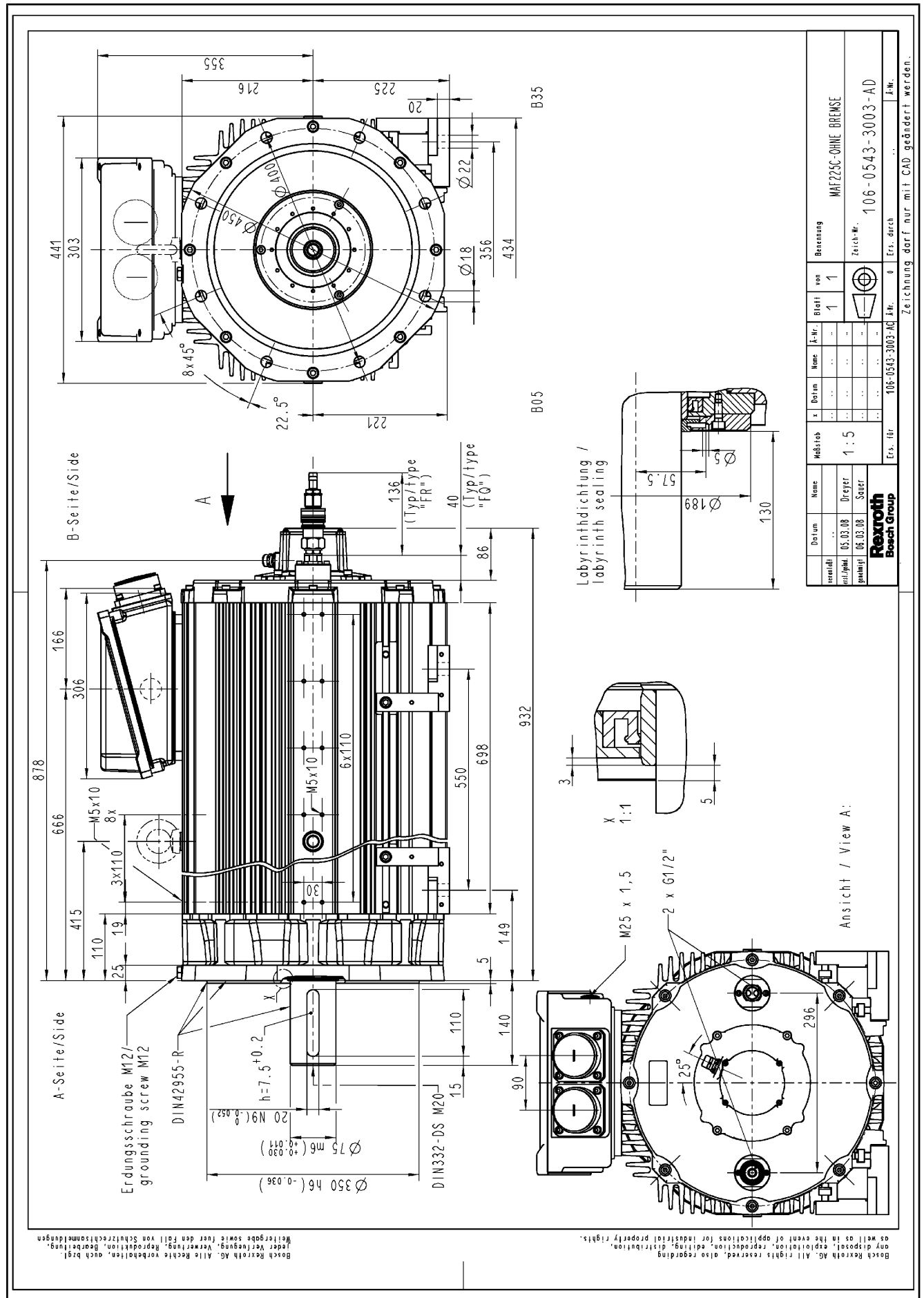

Fig.5-48: MAF225C without brake

Dimension Drawings IndraDyn A

5.10.3 MAF225 in Ex-type Design with M6 or S6 Encoder, without Brake

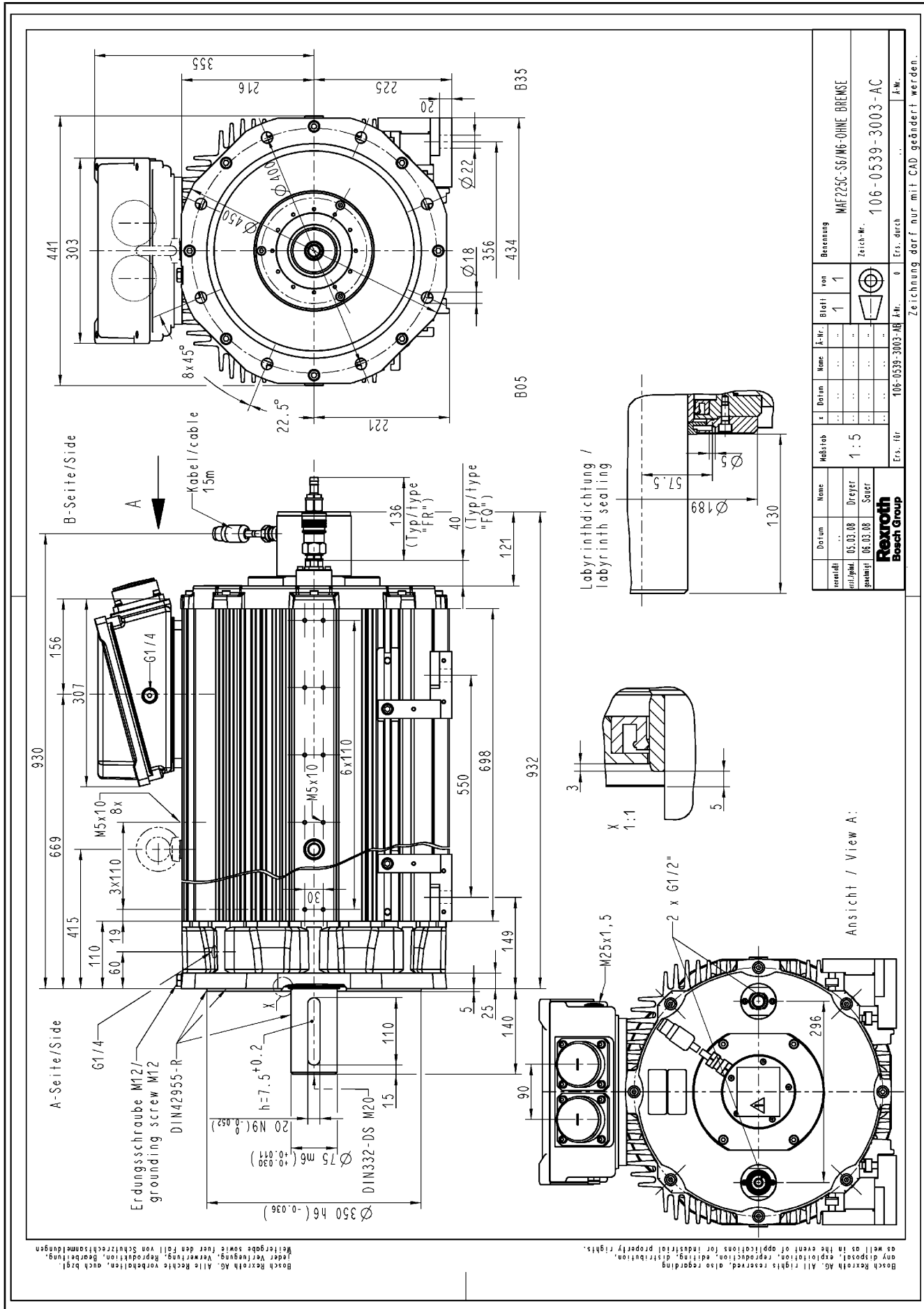

Fig.5-49: MAF225 with M6/S6 encoder, without brake

6 Type Codes IndraDyn A

6.1 Introduction

6.1.1 General Information

IndraDyn A is the general product name for the new asynchronous housing motors by REXROTH.

The type code describes the available motor variants and is the key to selecting the products and ordering them from BOSCH REXROTH. This applies to new products as well as to spare parts and repairs.

The following descriptions give an overview of the individual digits of the type ("short-text column") and their meaning.



When selecting a product, please also take the detailed information in the following chapters into account: chapter 4 "Technical Data"; chapter 9 "Application Guidelines"; chapter 13 "Motors for Potentially Explosive Atmospheres".

6.1.2 Definition

1. Product

Short-text columns 1-2-3

MAD is the name of the series of air-cooled asynchronous housing motors.

MAF is the name of the series of liquid-cooled asynchronous housing motors.

2. Motor Frame Size

Short-text columns 4-5-6

The motor frame size is derived from the mechanical dimensions of the flange on the output side and represents different power ranges.

3. Motor Frame Length

Short-text column 7

Increasing frame lengths of motors of one series are graded by code letters in alphabetical order.

For example, frame lengths can be **B**, **C** and **E**.

4. Winding Code

Short-text columns 9-10-11-12

The four-digit string identifies the rated speed which is applicable for the particular winding version. The last digit is omitted. Example: Winding code 0200 stands for a rated speed of 2000 min⁻¹.

5. Cooling Type

Short-text columns 14-15

MAD motors must always be operated with a fan. Air baffles guide the air currents of this fan over the surface of the motor ("surface cooling").

Operation without cooling is prohibited.

There are two options to cool MAD motors:

- Option "**SA**": Cooling via the mounted axial fan. The air current is defined as "blowing" according to the following figure.

Type Codes IndraDyn A

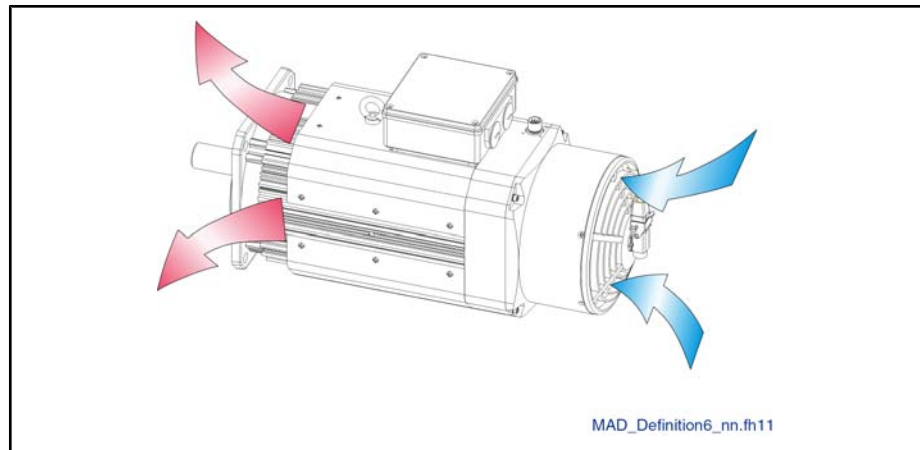

Fig.6-1: MAD, blowing axial fan

The fan unit can be dismantled for maintenance purposes.

- Option "SL": There are certain applications where MAD motors can also be operated with an external fan ([chapter 9.8 "Motor Cooling" on page 230](#)), e.g., in heavily soiled environments. This is achieved by equipping the motors with a fan cowl and a fan shroud for connecting an air tube.

MAF motors may only be operated in connection with an external cooling system (not included in the Rexroth delivery).

There are two options to connect MAF motors to the cooling system:

- Option "FQ": Coolant port via the connecting threads on the motor (for dimension, refer to the type code or dimension drawing).
- Option "FR": Coolant port via the enclosed quick coupling.

If connection with quick coupling (option "FR") is selected, the quick coupling must be screwed into the coolant port thread on the motor beforehand. Please also observe the information provided in [chapter 8.9.2 "Coolant Port" on page 219](#).

6. Motor Encoder

Short-text columns 17-18 IndraDyn A motors are available with integrated rotary encoders .

Option	Type	Periods	Signal ¹⁾	Interface	Supply voltage
S2	Single-turn absolute encoder	2048	1 V _{SS}	EnDat2.1	7 ... 12 V
M2	Multi-turn absolute encoder	2048	1 V _{SS}	EnDat2.1	7 ... 12 V
S6	Single-turn absolute encoder for Ex-type motors (connecting cable length 15 m)	2048	1 V _{SS}	EnDat2.1	7 ... 12 V
M6	Multi-turn absolute encoder for Ex-type motors (connecting cable length 15 m)	2048	1 V _{SS}	EnDat2.1	7 ... 12 V
C0	Incremental encoder	2048	1 V _{SS}	-	5 V
N0	The motor is delivered without any factory-mounted encoder unit. The motor is closed with a cover on its rear.				

¹⁾ All encoder signals are sinusoidal.

Fig.6-2: IndraDyn A motor encoders

7. Electrical Connection

Short-text column 20 Electric connection of the motors of frame size 100 ... 160 can be achieved either via a flange socket or a terminal box. Motors of frame size 180 ... 225 and Ex-type motors can only be connected via a terminal box.

For more information, please refer to the type code of the motor and [chapter 8 "Connection Methods" on page 207](#).

Type Codes IndraDyn A

8. Output Shaft

Short-text column 21

IndraDyn A motors provide the following options to connect the machine elements to be driven to the motor shafts:

Output shaft			
	Plain shaft	With keyway	
		Complete key, balanced	Half key, balanced
Without shaft sealing ring	H	Q	L
With shaft sealing ring	G	P	K
With labyrinth seal	F	R	M

Fig.6-3: Output shaft options

Motors which are provided with a keyway are always delivered with a key.

The output shafts of motors of frame sizes 130 ... 225 have threaded centering holes on their end faces. These "DS" type holes comply with DIN 332, sheet 2. Details can be found in the dimension drawing of the particular motor.

Please also observe the supplementary notes about shaft sealing ring, output shaft and labyrinth seal in [chapter 9.12 "Output Shaft "](#) on page 244.

9. Holding Brake

Short-text column 22

Up to frame size 180, IndraDyn A motors are optionally available with integrated holding brake and different holding torques. Depending on the application, either an **"electrically clamping"** or an **"electrically releasing"** brake can be selected.



The motor holding brake is not suitable for personal protection and cannot be used as a service brake. Please also observe the additional information on holding brakes in [chapter 9.10 "Holding Brake \(Optional\)"](#) on page 238 and [chapter 12.4.5 "Servicing and Commissioning Holding Brakes "](#) on page 286.

10. Frame Shape

Short-text columns 24-25

IndraDyn A motors are available in frame shape **05** (flanged attachment) or frame shape **35** (flanged and foot installation). The allowed installation types are described in [chapter 9.6 "Frame Shape and Installation Position "](#) on page 227.

11. Bearing

Short-text column 27

- **Standard bearings** (option "N") consists of deep-groove ball bearings for all IndraDyn A motors.
- **A-sided fixed bearings** (option "A") also consist of deep-groove ball bearings. In contrast to other bearing models, however, fixed bearings are arranged on side A. This bearing is particularly suitable if circumferential radial forces must be expected during operation or if other attachment parts are to be connected to the motor shaft via a coupling.

Type Codes IndraDyn A

- **Reinforced bearings** (option "V") can be used when high radial forces must be absorbed. Reinforced bearings feature a cylindrical roller bearing in addition to the deep-groove ball bearing on side A.
- **High-speed bearings** (option "H") allow higher speeds with reduced axial and radial load bearing capacity.

Please also observe the additional information on bearing models in the motor data sheet in [chapter 4 "Technical Data" on page 27](#) and [chapter 9.13 "Bearing Variants and Shaft Load" on page 247](#).

12. Oscillating Quantity Level

Short-text column 28 IndraDyn A motors are dynamically balanced in accordance with the requirements of EN 60034-14:2004. The standard oscillating quantity level of the motors is level "A". An additional oscillating quantity level "B" or "C" can be selected for various motor frame sizes. For more information on motor oscillating quantity levels, please refer to [chapter 9.17 "Oscillating Quantity Level" on page 265](#).

© Bosch Rexroth AG 2010

ZN-40001-100_NOR_N_EN_2011-01-24.fh11

Short text column	1									2									3									4											
	1	2	3	4	5	6	7	8	9	0	1	2	3	4	5	6	7	8	9	0	1	2	3	4	5	6	7	8	9	0	1	2	3	4	5	6	7	8	9
Example:	M	A	D	1	0	0	C	-	0	1	0	0	-	S	A	-	S	2	-	B	H	0	-	0	5	-	N	1											

Electrical connection see picture 1 ②

A-Side	A	E
B-Side	B	H
Right	R	D
Left	L	G

Shaft ③

Without shaft sealing ring	H	Q	L
With shaft sealing ring	G	P	K
With labyrinth seal	F	R	M

Holding brake

Without holding brake = 0
 Electrically-released, 24 Nm = 1
 Electrically-clamped, 30 Nm = 5

Mounting style

Flange mounting = 05
 Flange and foot mounting = 35

Bearing ④

Fixed bearing A-side = A
 Standard = N
 High Speed = H

Vibration severity

A, according to DIN EN 60034-14 = 1
 B, according to DIN EN 60034-14 = 3
 C, specification according to IndraDyn A - documentation = 4 ⑤

Position of power connection = top



Picture 1

Note:

- ① Ex type for cluster II 2G Ex pd IIB T3 according to DIN EN 60079 ff. Encoder "M6" or S6" are only available with Cooling mode "SL", not with Electrical connection "A", "B", "R" and "L" and only with Shaft "G", "P" or "K" and bearing "A" or "N"
- ② According to DIN IEC 60204-1 and DIN IEC 60364-5-52
- ③ Shaft "F", "M" and "R" are only available with shaft sealing ring
- ④ Bearing "A" is only available with Holding brake "0" and Vibration severity "1"
 Bearing "H" is not available with Encoder "S6" und "M6" and only with Shaft "H" and Holding brake "0"
- ⑤ Vibration severity "4" is only available with Length "B" or "C" and Bearing "N" or "H"

Normative references

Publication	Edition	Title
DIN EN 60034-14	2008-03	Rotating electrical machines - Part 14
DIN EN 60079 ff	-	Electrical apparatus for explosive gas atmospheres (ATEX)
DIN IEC 60204-1	2002-09	Safety for machinery - Electrical equipment of machines - Part 1
DIN IEC 60364-5-52	2004-07	Erection of low voltage installation - Part 5

Fig.6-5: Type code MAD100 (2/2)

© Bosch Rexroth AG 2010
 ZN-40001-130_NOR_N_EN_2011-01-24.fh11

Short text column	1	2	3	4	5	6	7	8	9	0	1	2	3	4	5	6	7	8	9	0	1	2	3	4	5	6	7	8	9	0	1	2	3	4	5	6	7	8	9	0
Example:	M	A	D	1	3	0	B	-	0	1	5	0	-	S	A	-	S	2	-	A	G	0	-	0	5	-	N	1												

Electrical connection see picture 1 ②

	Connector	Terminal box, turnable
A-Side	A	E
B-Side	B	H
Right	R	D
Left	L	G



Picture 1

Shaft ③

	plain shaft	with key	
		balanced with entire key	balanced with half key
Without shaft sealing ring	H	Q	L
With shaft sealing ring	G	P	K
With labyrinth seal	F	R	M

Holding brake

Without holding brake = 0
 Electrically-released, 80 Nm = 1
 Electrically-clamped, 100 Nm = 5

Mounting style

Flange mounting = 05
 Flange and foot mounting = 35

Bearing ④

Fixed bearing A-side = A
 Standard = N
 High Speed = H
 Reinforced bearing = V

Vibration severity

A, according to DIN EN 60034-14 = 1
 B, according to DIN EN 60034-14 = 3
 C, spezifikation according to IndraDyn A - documentation = 4 ⑤

Note:

- ① Ex type for cluster II 2G Ex pd IIB T3 according to DIN EN 60079 ff. Encoder "M6" or S6" are only available with Cooling mode "SL", not with Electrical connection "A", "B", "R" and "L" and only with Shaft "G", "P" or "K" and bearing "A", "N" or "V"
- ② According to DIN IEC 60204-1 and DIN IEC 60364-5-52
- ③ Shaft "F", "M" and "R" are only available with shaft sealing ring
- ④ Bearing "A" is only available with Holding brake "0" and Vibration severity "1"
 Bearing "H" is not available with Encoder "S6" und "M6" and only with Shaft "H" and Holding brake "0"
- ⑤ Vibration severity "4" is only available with Length "B" or "C" and Bearing "N" or "H"

Normative references

Publication	Edition	Title
DIN EN 60034-14	2008-03	Rotating electrical machines - Part 14
DIN EN 60079 ff	-	Electrical apparatus for explosive gas atmospheres (ATEX)
DIN IEC 60204-1	2002-09	Safety for machinery - Electrical equipment of machines - Part 1
DIN IEC 60364-5-52	2004-07	Erection of low voltage installation - Part 5

Fig.6-7: Type code MAD130 (2/2)

Type Codes IndraDyn A

6.4 Type Code MAD160

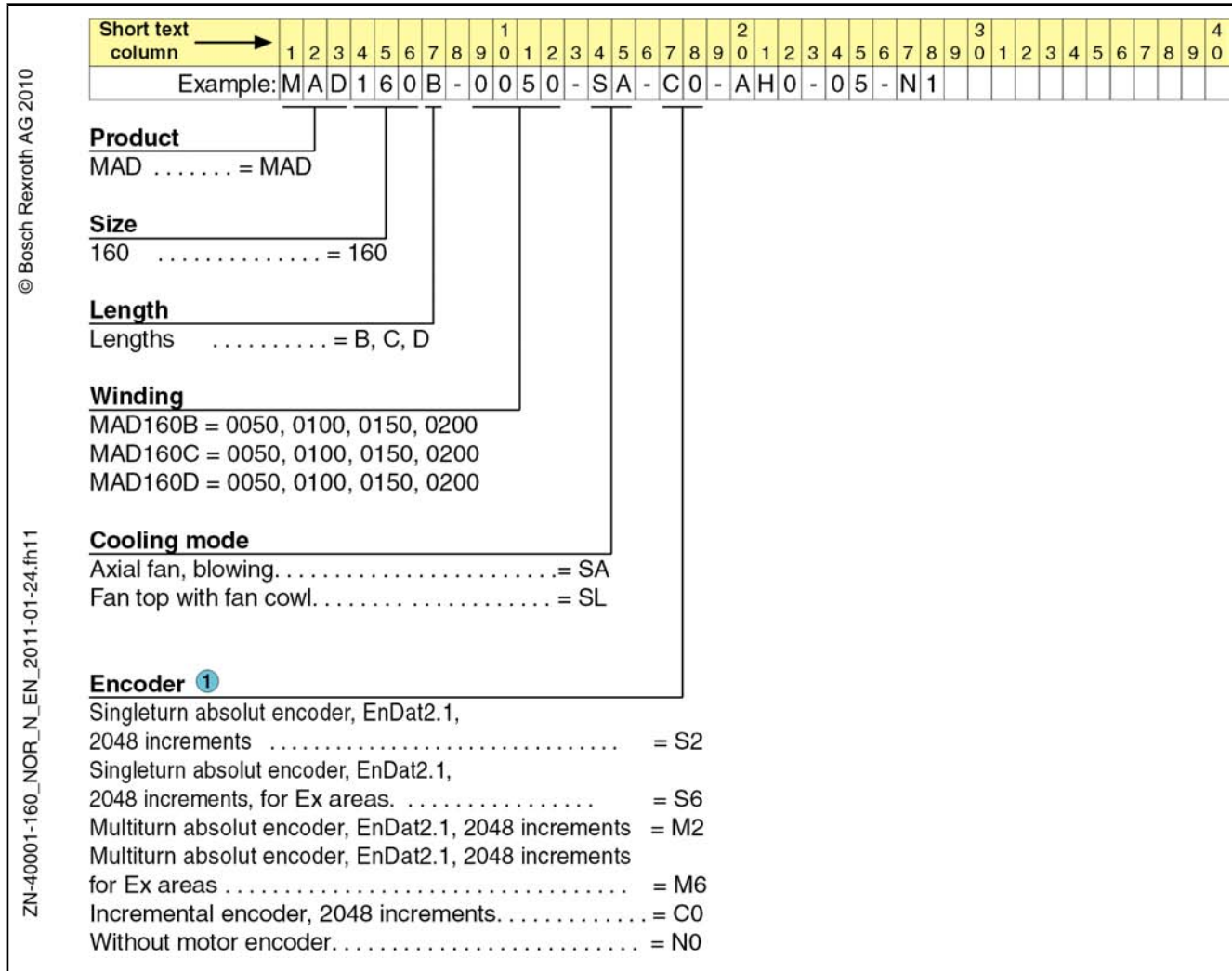

© Bosch Rexroth AG 2010

ZN-40001-160_NOR_N_EN_2011-01-24.fh11

Fig.6-8: Type code MAD160 (1/2)

© Bosch Rexroth AG 2010

ZN-40001-160_NOR_N_EN_2011-01-24.fh11

Short text column	1	2	3	4	5	6	7	8	9	0	1	2	3	4	5	6	7	8	9	0	1	2	3	4	5	6	7	8	9	0	1	2	3	4	5	6	7	8	9	0	1	2	3	4	5	6	7	8	9	0							
Example:	M	A	D	1	6	0	B	-	0	0	5	0	-	S	A	-	C	0	-	A	H	0	-	0	5	-	N	1																													

Electrical connection see picture 1 ②

	Connector	Terminal box, turnable
A-Side	A	E
B-Side	B	H
Right	R	D
Left	L	G

Shaft ③

	plain shaft	with key	
		balanced with entire key	balanced with half key
Without shaft sealing ring	H	Q	L
With shaft sealing ring	G	P	K
With labyrinth seal	F	R	M

Holding brake

Without holding brake = 0
 Electrically-released, 100 Nm = 1
 Electrically-released, 240 Nm = 3
 Electrically-clamped, 100 Nm = 5

Mounting style

Flange mounting = 05
 Flange and foot mounting = 35

Bearing ④

Fixed bearing A-side = A
 Standard = N
 High Speed = H
 Reinforced bearing = V

Vibration severity

A, according to DIN EN 60034-14 = 1
 B, according to DIN EN 60034-14 = 3
 C, spezification according to IndraDyn A - documentation = 4 ⑤

Note:

- ① Ex type for cluster II 2G Ex pd IIB T3 according to DIN EN 60079 ff. Encoder "M6" or S6" are only available with Cooling mode "SL", not with Electrical connection "A", "B", "R" and "L" and only with Shaft "G", "P" or "K" and Bearing "A", "N" or "V"
- ② According to DIN IEC 60204-1 and DIN IEC 60364-5-52
- ③ Shaft "F", "M" and "R" are only available with shaft sealing ring
- ④ Bearing "A" is only available with Holding brake "0" and Vibration severity "1"
 Bearing "H" is not available with Encoder "S6" und "M6" and only with Shaft "H" and Holding brake "0"
- ⑤ Vibration severity "4" is only available with Bearing "N"

Normative references

Publication	Edition	Title
DIN EN 60034-14	2008-03	Rotating electrical machines - Part 14
DIN EN 60079 ff	-	Electrical apparatus for explosive gas atmospheres (ATEX)
DIN IEC 60204-1	2002-09	Safety for machinery - Electrical equipment of machines - Part 1
DIN IEC 60364-5-52	2004-07	Erection of low voltage installation - Part 5

Position of power connection = top

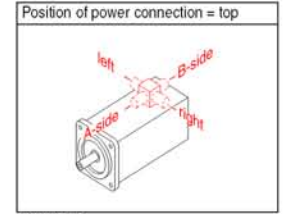

Picture 1

Fig. 6-9: Type code MAD160 (2/2)

Type Codes IndraDyn A

6.5 Type Code MAD180

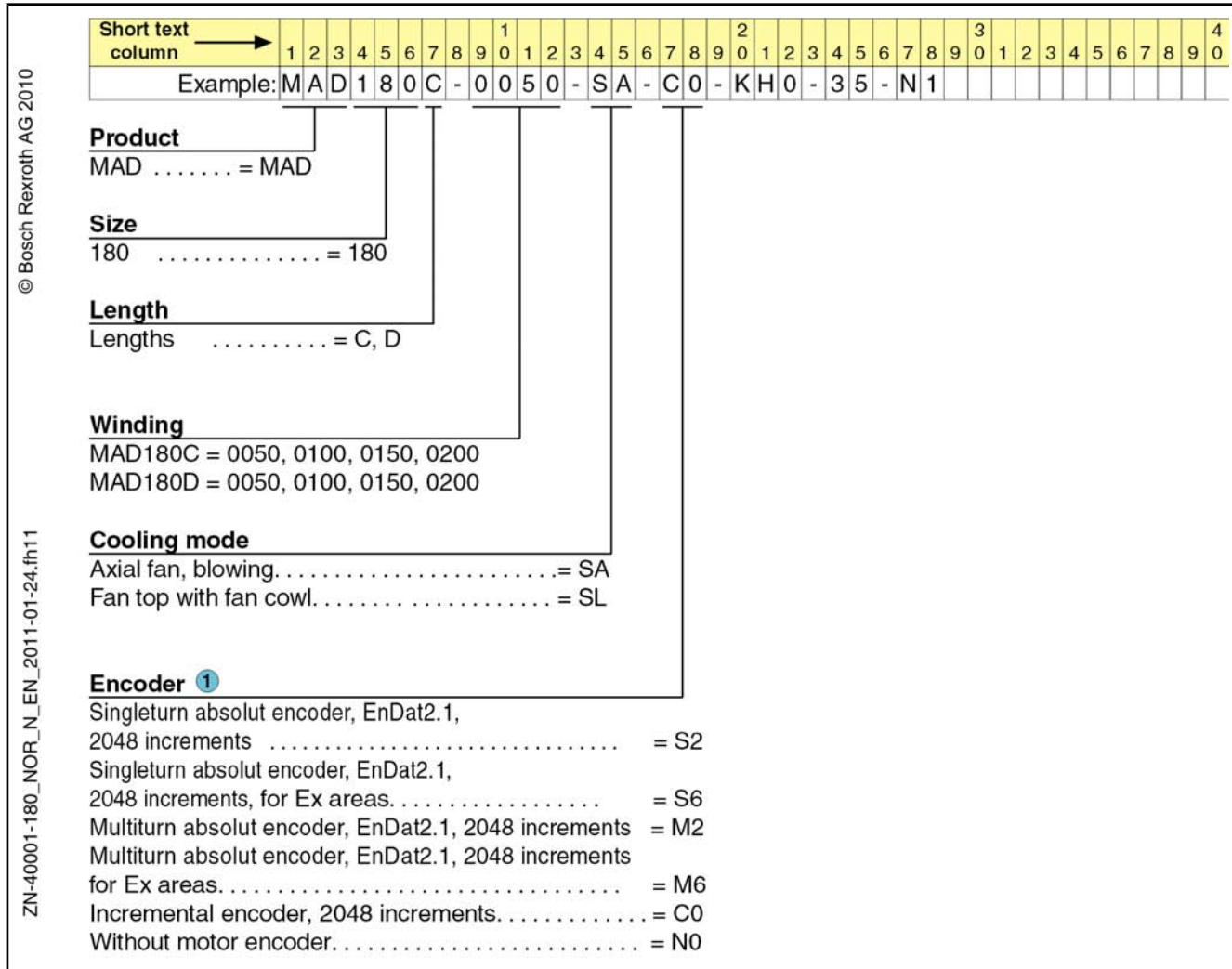

ZN-40001-180_NOR_N_EN_2011-01-24:fh11

Fig.6-10: Type code MAD180 (1/2)

© Bosch Rexroth AG 2010
ZN-40001-180_NOR_N_EN_2011-01-24.fh11

Short text column →	1	2	3	4	5	6	7	8	9	0	1	2	3	4	5	6	7	8	9	0	2	0	1	2	3	4	5	6	7	8	9	0	3	0	1	2	3	4	5	6	7	8	9	0	4									
Example:	M	A	D	1	8	0	C	-	0	0	5	0	-	S	A	-	C	0	-	K	H	0	-	3	5	-	N	1																										

Electrical connection see picture 1 ②

	Terminal box, turnable
A-Side	E
B-Side	H
Right	D
Left	G

Shaft ③

	plain shaft	with key	
		balanced with entire key	balanced with half key
Without shaft sealing ring	H	Q	L
With shaft sealing ring	G	P	K
With labyrinth seal	F	R	M

Holding brake
 Without holding brake = 0
 Electrically-released, 240 Nm = 2
 Electrically-clamped, 100 Nm = 5

Mounting style
 Flange and foot mounting = 35

Bearing ④
 Fixed bearing A-side = A
 Standard = N
 Reinforced bearing = V

Vibration severity
 A, according to DIN EN 60034-14 = 1
 B, according to DIN EN 60034-14 = 3
 C, spezification according to IndraDyn A - documentation. = 4 ⑤

Note:
 ① Ex type for cluster II 2G Ex pd IIB T3 according to DIN EN 60079 ff. Encoder "M6" or S6" are only available with Cooling mode "SL", Shaft "G", "P" or "K" and Bearing "A", "N" or "V"
 ② According to DIN IEC 60204-1 and DIN IEC 60364-5-52
 ③ Shaft "F", "M" and "R" are only available with shaft sealing ring
 ④ Bearing "A" is only available with Holding brake "0" and Vibration severity "1"
 ⑤ Vibration severity "4" is only available with Length "C" and Bearing "N"

Normative references

Publication	Edition	Title
DIN EN 60034-14	2008-03	Rotating electrical machines - Part 14
DIN EN 60079 ff	-	Electrical apparatus for explosive gas atmospheres (ATEX)
DIN IEC 60204-1	2002-09	Safty for machinery - Electrical equipment of machines - Part 1
DIN IEC 60364-5-52	2004-07	Erection of low voltage installation - Part 5

Picture 1

Fig.6-11: Type code MAD180 (2/2)

Type Codes IndraDyn A

6.6 Type Code MAD225

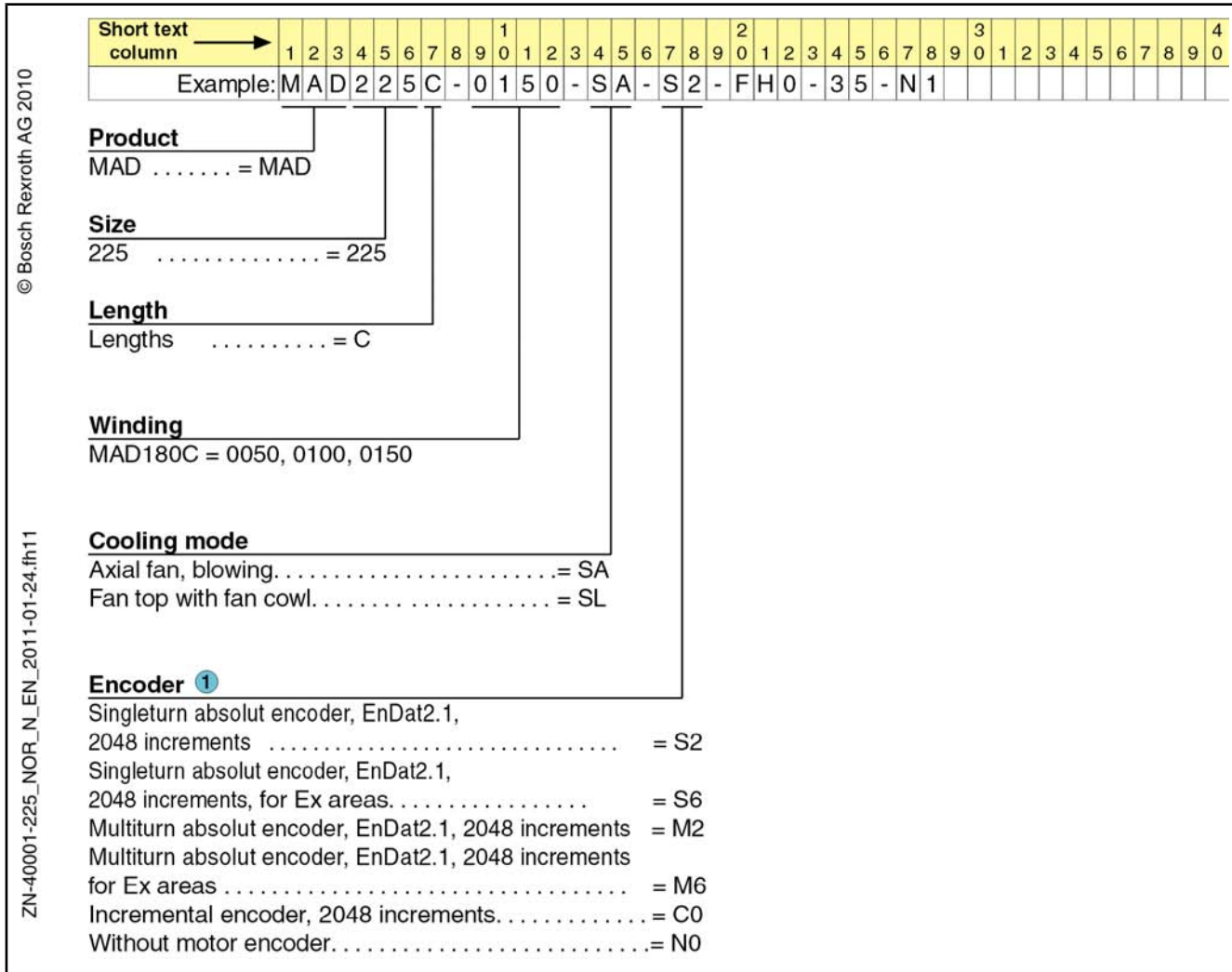

Fig.6-12: Type code MAD225 (1/2)

© Bosch Rexroth AG 2010

ZN-40001-225_NOR_N_EN_2011-01-24.fh11

Short text column	1	2	3	4	5	6	7	8	9	0	1	2	3	4	5	6	7	8	9	0	2	0	1	2	3	4	5	6	7	8	9	0	3	0	1	2	3	4	5	6	7	8	9	0	4	0
	Example: MAD225C - 0150 - SA - C2 - FH0 - 35 - N1																																													

Electrical connection see picture 1 ②

	Terminal box, turnable
A-Side	E
B-Side	H
Right	D
Left	G

Shaft ③

	plain shaft	with key	
		balanced with entire key	balanced with half key
Without shaft sealing ring	H	Q	L
With shaft sealing ring	G	P	K
With labyrinth seal	F	R	M

Holding brake
Without holding brake = 0

Mounting style
Flange mounting = 05
Flange and foot mounting = 35

Bearing
Standard = N
Reinforced bearing = V

Vibration severity
A, according to DIN EN 60034-14 = 1

Note:

- ① Ex type for cluster II 2G Ex pd IIB T3 according to DIN EN 60079 ff.
Encoder "M6" or S6" are only available with Cooling mode "SL", Shaft "G", "P" or "K"
- ② According to DIN IEC 60204-1 and DIN IEC 60364-5-52
- ③ Shaft "F", "M" and "R" are only available with shaft sealing ring

Normative references

Publication	Edition	Title
DIN EN 60034-14	2008-03	Rotating electrical machines - Part 14
DIN EN 60079 ff	-	Electrical apparatus for explosive gas atmospheres (ATEX)
DIN IEC 60204-1	2002-09	Safety for machinery - Electrical equipment of machines - Part 1
DIN IEC 60364-5-52	2004-07	Erection of low voltage installation - Part 5

Position of power connection = top

Picture 1

Fig.6-13: Type code MAD225 (2/2)

Type Codes IndraDyn A

6.7 Type Code MAF100

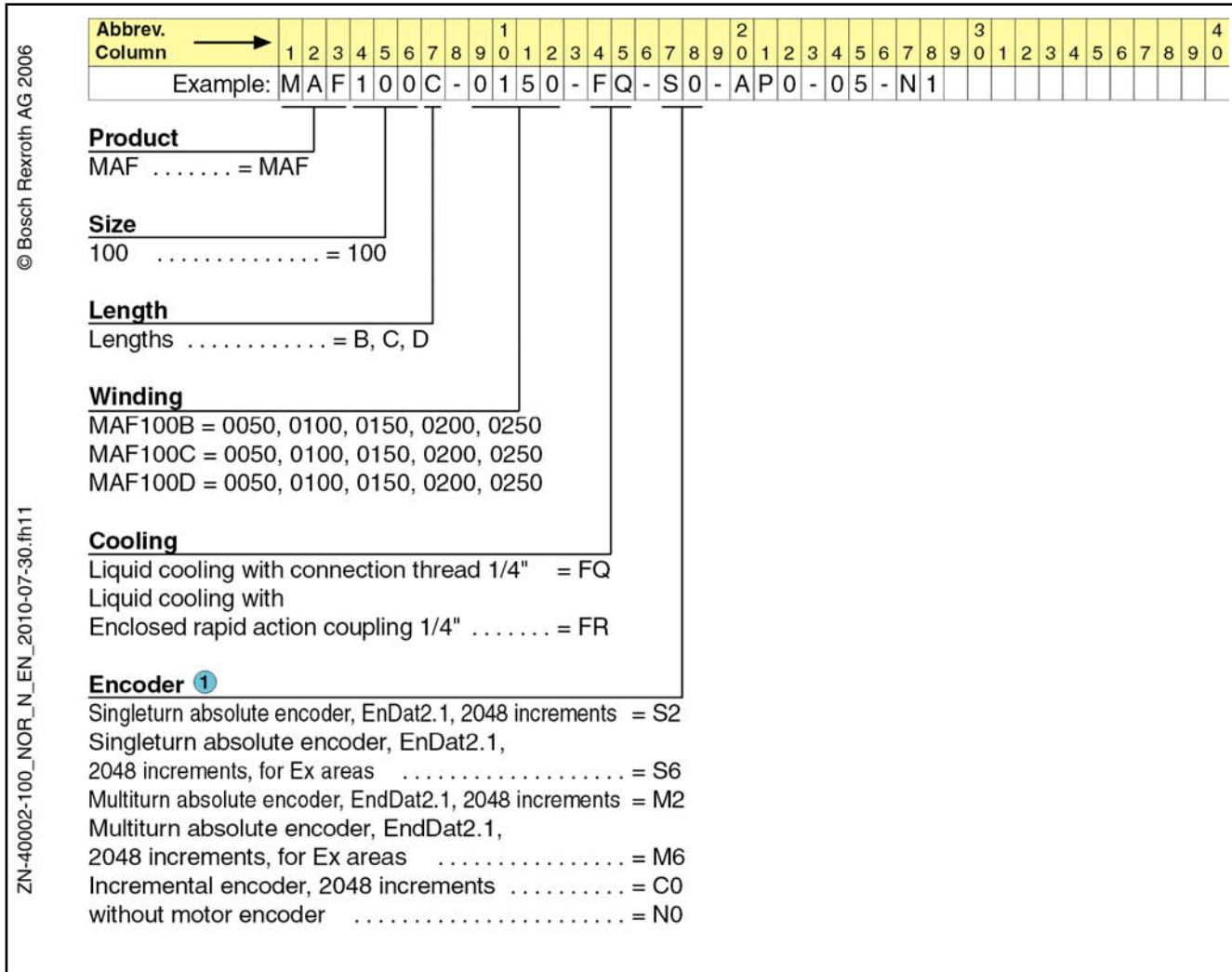
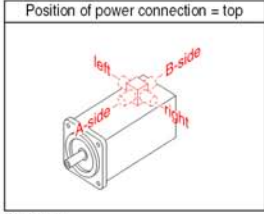

Fig.6-14: Type code MAF100 (1/2)

Abbrev. Column	1	2	3	4	5	6	7	8	9	0	1	2	3	4	5	6	7	8	9	0	2	1	2	3	4	5	6	7	8	9	0	3	0	1	2	3	4	5	6	7	8	9	0	4
Example:	M	A	F	1	0	0	C	-	0	1	5	0	-	F	Q	-	S	0	-	A	P	0	-	0	5	-	N	1																

Electrical connection see picture 1 ②

	Connector	Terminal box, turnable
A-Side	A	E
B-Side	B	H
Right	R	D
Left	L	G



Position of power connection = top

Picture 1

Shaft ③

	plain shaft	with key	
		balanced with entire key	balanced with half key
Without shaft sealing ring	H	Q	L
With shaft sealing ring	G	P	K
With labyrinth seal	F	R	M

Holding brake

Without holding brake = 0
 Electrically-released, 24 Nm = 1
 Electrically-clamped, 30 Nm = 5

Mounting style

Flange mounting = 05
 Flange and foot mounting = 35

Bearing ④

Fixed bearing A-side = A
 Standard = N
 High Speed = H

Vibration severity

A, according to DIN EN 60034-14 = 1
 B, according to DIN EN 60034-14 = 3
 C, specification according to IndraDyn A - documentation = 4 ⑤

Note:

- ① Ex type for cluster II 2G Ex pd IIB T3 according to DIN EN 60079 ff. Encoder "M6" and "S6" are not available with electrical connection "A", "B", "R" and "L" and only with shaft "G", "P" and "K" and bearings "A" and "N"
- ② According to DIN IEC 60204-1 and DIN IEC 60364-5-52
- ③ Shaft "F", "M" and "R" always available with shaft sealing ring
- ④ Bearing "A" is only available with holding brake "0" and vibration severity "1"
 Bearing "H" is not available with encoder "S6" and "M6" and only with shaft "H" and holding brake "0"
- ⑤ Vibration severity "4" is only available with length "B" and "C" and bearing "N" and "H"

Standard reference

Standard	Edition	Title
DIN EN 60034-14	2008-03	Rotating electrical machines - Part 14
DIN EN 60079 ff	-	Electrical apparatus for explosive gas atmospheres (ATEX)
DIN IEC 60204-1	2002-09	Safety of machinery - Electrical equipment of machines - Part 1
DIN IEC 60364-5-52	2004-07	Erection of low voltage installation - Part 5

Fig.6-15: Type code MAF100 (2/2)

Type Codes IndraDyn A

6.8 Type Code MAF130

Abbrev. Column	1	2	3	4	5	6	7	8	9	0	1	2	3	4	5	6	7	8	9	0	1	2	3	4	5	6	7	8	9	0	1	2	3	4	5	6	7	8	9	0					
Example:	M	A	F	1	3	0	B	-	0	1	5	0	-	F	Q	-	M	0	-	L	H	0	-	0	5	-	N	1																	

Product
 MAF = MAF

Size
 130 = 130

Length
 Lengths = B, C, D

Winding ①
 MAF130B = 0050, 0100, 0150, 0200, 0250
 MAF130C = 0050, 0100, 0150, 0200, 0250
 MAF130D = 0050, 0100, 0150, 0200, 0250

Cooling
 Liquid cooling with connection thread 1/4" = FQ
 Liquid cooling with enclosed rapid action coupling 1/4" = FR

Encoder ②
 Singleturn absolute encoder, EnDat2.1, 2048 increments = S2
 Singleturn absolute encoder, EnDat2.1, 2048 increments, for Ex areas = S6
 Multiturn absolute encoder, EndDat2.1, 2048 increments = M2
 Multiturn absolute encoder, EndDat2.1, 2048 increments, for Ex areas = M6
 Incremental encoder, 2048 increments = C0
 without motor encoder = N0

© Bosch Rexroth AG 2006
 ZN-40002-130_NOR_N_EN_2010-07-30.fn11

Fig.6-16: Type code MAF130 (1/2)

Type Codes IndraDyn A

Abbrev. Column	1	2	3	4	5	6	7	8	9	0	1	2	3	4	5	6	7	8	9	0	1	2	3	4	5	6	7	8	9	0	1	2	3	4	5	6	7	8	9	0
Example:	M	A	F	1	3	0	B	-	0	1	5	0	-	F	Q	-	M	0	-	L	H	0	-	0	5	-	N	1												

Electrical connection see picture 1 ③

	Connector	Terminal box, turnable
A-Side	A	E
B-Side	B	H
Right	R	D
Left	L	G

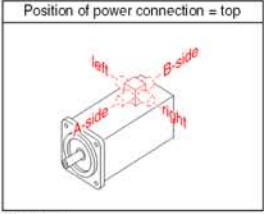

Position of power connection = top

left B-side
A-side right

Picture 1

Shaft ④

	plain shaft	with key	
		balanced with entire key	balanced with half key
Without shaft sealing ring	H	Q	L
With shaft sealing ring	G	P	K
With labyrinth seal	F	R	M

Holding brake

Without holding brake = 0
 Electrically-released, 80 Nm = 1
 Electrically-clamped, 100 Nm = 5

Mounting style

Flange mounting = 05
 Flange and foot mounting = 35

Bearing ⑤

Fixed bearing A-side = A
 Standard = N
 High Speed = H
 Reinforced bearings = V

Vibration severity

A, according to DIN EN 60034-14 = 1
 B, according to DIN EN 60034-14 = 3
 C, specification according to IndraDyn A - documentation = 4 ⑥

Note:

- ① Winding "0250" with length "D" is not available with electrical connection "A", "B", "R" and "L"
- ② Ex type for cluster II 2G Ex pd IIB T3 according to DIN EN 60079 ff. Encoder "M6" and "S6" are not available with el. connection "A", "B", "R" and "L" and only with shaft "G", "P" and "K" and bearings "A", "N" and "V"
- ③ According to DIN IEC 60204-1 and DIN IEC 60364-5-52
 Electrical connection "D" and "G" is not available with length "B"
 Electrical connection "E" is only available with length "D"
- ④ Shaft "F", "M" and "R" always available with shaft sealing ring
- ⑤ Bearing "A" is only available with holding brake "0" and vibration severity "1"
 Bearing "H" is not available with encoder "S6" and "M6" and only with shaft "H" and holding brake "0"
- ⑥ Vibration severity "4" is only available with length "B" and "C" and bearings "N" and "H"

Standard reference

Standard	Edition	Title
DIN EN 60034-14	2008-03	Rotating electrical machines - Part 14
DIN EN 60079 ff	-	Electrical apparatus for explosive gas atmospheres (ATEX)
DIN IEC 60204-1	2002-09	Safety of machinery - Electrical equipment of machines - Part 1
DIN IEC 60364-5-52	2004-07	Erection of low voltage installation - Part 5

Fig.6-17: Type code MAF130 (2/2)

Type Codes IndraDyn A

6.9 Type Code MAF160

© Bosch Rexroth AG 2006

ZN-40002-160_NOR_N_EN_2010-07-30.fh11

Abbrev. Column →	1	2	3	4	5	6	7	8	9	0	1	2	3	4	5	6	7	8	9	0	1	2	3	4	5	6	7	8	9	0	1	2	3	4	5	6	7	8	9	0	1	2	3	4	5	6	7	8	9	0		
Example:	M	A	F	1	6	0	B	-	0	2	0	0	-	F	Q	-	M	0	-	K	G	0	-	0	5	-	N	1																								

Product
MAF = MAF

Size
160 = 160

Length
Lengths = B, C

Winding ①
MAF160B ... = 0050, 0100, 0150, 0200
MAF160C ... = 0050, 0100, 0150, 0200

Cooling
Liquid cooling with connection thread 1/2" = FQ
Liquid cooling with enclosed rapid action coupling 1/2" = FR

Encoder ②
Singleturn absolute encoder, EnDat2.1, 2048 increments = S2
Singleturn absolute encoder, EnDat2.1, 2048 increments, for Ex areas = S6
Multiturn absolute encoder, EndDat2.1, 2048 increments = M2
Multiturn absolute encoder, EndDat2.1, 2048 increments, for Ex areas = M6
Incremental encoder, 2048 increments = C0
without motor encoder = N0

Fig.6-18: Type code MAF160 (1/2)

Type Codes IndraDyn A

6.10 Type Code MAF180

© Bosch Rexroth AG 2006

Abbrev. Column →	1	2	3	4	5	6	7	8	9	0	1	2	3	4	5	6	7	8	9	0	2	0	1	2	3	4	5	6	7	8	9	0	3	0	1	2	3	4	5	6	7	8	9	0	4	0									
Example:	M	A	F	1	8	0	C	-	0	0	5	0	-	F	Q	-	C	0	-	C	H	0	-	3	5	-	N	1																											

Product
MAF = MAF

Size
180 = 180

Length
Lengths = C, D

Winding
MAF180B ... = 0050, 0100, 0150, 0200
MAF180C ... = 0050, 0100, 0150, 0200

Cooling
Liquid cooling with connection thread 1/2" = FQ
Liquid cooling with enclosed rapid action coupling 1/2" = FR

Encoder ①
Singleturn absolute encoder, EnDat2.1, 2048 increments = S2
Singleturn absolute encoder, EnDat2.1, 2048 increments, for Ex areas = S6
Multiturn absolute encoder, EndDat2.1, 2048 increments = M2
Multiturn absolute encoder, EndDat2.1, 2048 increments, for Ex areas = M6
Incremental encoder, 2048 increments = C0
without motor encoder = N0

ZN-40002-180_NOR_N_EN_2010-07-30.fh11

Fig.6-20: Type code MAF180 (1/2)

Type Codes IndraDyn A

Abbrev. Column	1									2									3									4												
	1	2	3	4	5	6	7	8	9	0	1	2	3	4	5	6	7	8	9	0	1	2	3	4	5	6	7	8	9	0	1	2	3	4	5	6	7	8	9	0
Example:	M	A	F	2	2	5	C	-	0	1	5	0	-	F	Q	-	S	2	-	F	K	0	-	3	5	-	N	1												

Electrical connection see picture 1 ②

	Terminal box, turnable
A-Side	E
B-Side	H
Right	D
Left	G

Position of power connection = top

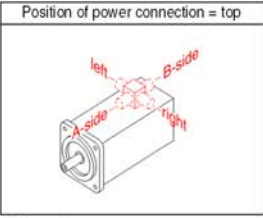

Picture 1

Shaft ③

	plain shaft	with key	
		balanced with entire key	balanced with half key
Without shaft sealing ring	H	Q	L
With shaft sealing ring	G	P	K
With labyrinth sealing	F	R	M

Holding brake

without holding brake = 0

Mounting style

Flange mounting = 05

Flange and foot mounting = 35

Bearings

Standard = N

Reinforced bearings = V

Vibration severity

A, according to DIN EN 60034-14 = 1

Note:

- ① Ex type for cluster II 2G EEx pd IIB T3 according to DIN EN 60079 ff.
Encoder "M6" and "S6" are only available with shaft "G", "P" and "K"
- ② According to DIN IEC 60204-1 and DIN IEC 60364-5-52
- ③ Shaft "F", "M" and "R" are always available with shaft sealing ring

Standard reference

Standard	Edition	Title
DIN EN 60034-14	2008-03	Rotating electrical machines - Part 14
DIN EN 60079 ff	-	Electrical apparatus for explosive gas atmospheres (ATEX)
DIN IEC 60204-1	2002-09	Safety of machinery - Electrical equipment of machines - Part 1
DIN IEC 60364-5-52	2004-07	Erection of low voltage installation - Part 5

Fig. 6-23: Type code MAF225 (2/2)

7 Accessories

7.1 Sealing Air Connection

When the motor is used under adverse conditions, a higher degree of protection than the standard one (IP 65 with radial shaft sealing ring) may be required. This is especially the case when the motors are used in areas where the tightness of the motor seals must meet highest requirements because oily cooling lubricants are used. In these areas of application, we recommend that you use sealing air in addition to the radial shaft sealing ring.

A defined overpressure which is introduced into the interior of the motor reliably prevents, e.g., creep oils and cooling lubricants from ingressing.

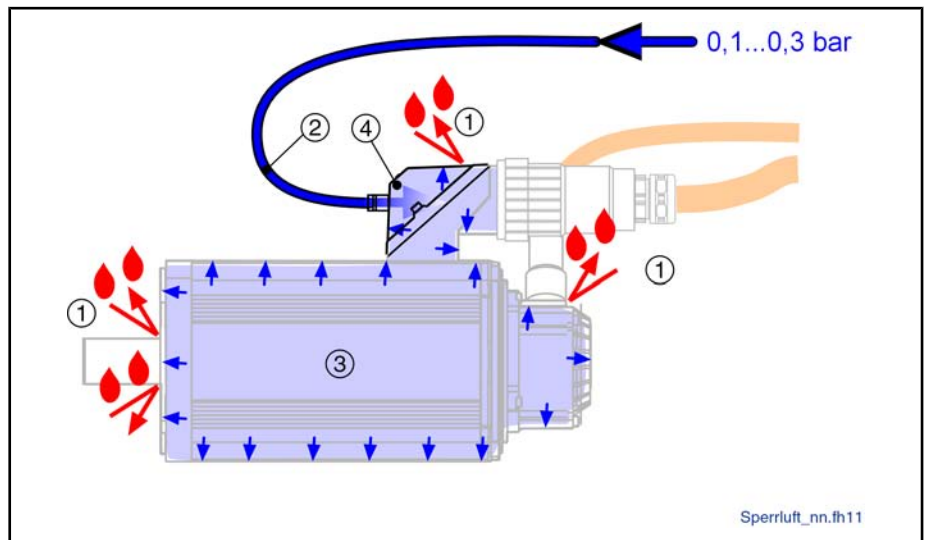

- ① Splash water, cooling lubricant
- ② Compressed air line
- ③ Overpressure inside the motor
- ④ Lid for sealing air (with connection piece for compressed air line)

Fig.7-1: Motor with sealing air connection

Sealing air connections are available as accessory parts for IndraDyn A motors of frame sizes 100 to 160, which are equipped with connector socket for power connection.

Order designations of accessory kits

Motor frame size MAD / MAF	Motor flange socket (type)	Designation
100	INS0480	SUP-M01-MHD (MNR R911283006)
130 ... 160	INS0380	SUP-M02-MHD (MNR R911283007)

Fig.7-2: Accessories for sealing air connection

The sealing air connection can be retrofitted by simply replacing the existing lid with the lid in the accessory kit. This lid then features the connection piece for the compressed air line.

Accessories

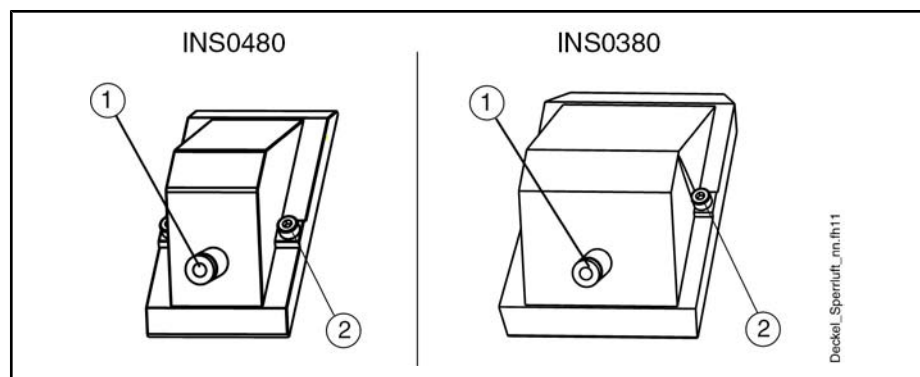

- ① Compressed air line connection piece
② Mounting screws (2x)

Fig.7-3: Lid for sealing air connection



When mounting the lid, ensure that the O-ring is properly positioned in the lid. The degree of protection required for the motor is only ensured by a properly seated O-ring.

- Tightening torque of the two mounting screws: 3 Nm.
- Mounting instructions are enclosed with the accessory kit selected.

Technical data

The motor may only be operated with sealing air under the following conditions:

- Motor shaft with shaft sealing ring
- System pressure applied to the motor
 - 0.1 ... 0.2 bar
- Compressed air composition
 - Free from dust and oil to the highest possible extent (select an appropriate filter)
 - Relative air humidity 20 ... 30 %

Additional components

To operate the motor with sealing air under the above-mentioned conditions, other devices or components are required, e.g.,

- compressor,
- pressure regulating valve,
- compressed air filter and, if necessary, compressed air dryer,
- compressed air line (e.g., plastic tube PA 4 x 0.75).

These devices and components must be procured and installed by the user as required.

For information on the selection and dimensioning of suitable Rexroth accessories, please contact your sales partner, or directly address

Supplier of additional components

Bosch Rexroth AG
Pneumatics
Ulmer Str. 4
30880 Laatzen, Germany
Phone: +49 (511) 21 36-0
Fax: +49 (511) 2 13 62-69

7.2 Gearboxes

Under certain conditions, IndraDyn A motors are suitable for the attachment of control and planetary gearboxes.

In this case, Bosch Rexroth recommends gearboxes of the Rexroth GTM series which are compatible with IndraDyn A motors.

Type	Gearbox type	Motor requirements	Supplier
GTM	Planetary gearboxes	Plain motor shaft	Bosch Rexroth

Fig. 7-4: Gearboxes for IndraDyn A motors

When selecting the gearbox, please note the information in the type code of the GTM gearbox.

The compatibility and availability of gearboxes from other manufacturers or other gearbox types must be clarified with the particular gearbox manufacturer. Please also observe the information provided in [chapter 9.14.2 "Gearboxes" on page 258](#).



Only low axial shaft loads are allowed for IndraDyn A motors (see [chapter 9.13 "Bearing Variants and Shaft Load" on page 247](#)). For this reason, IndraDyn A motors are not suitable for machine elements which generate axial motor loads (e.g., helical driving pinions) or are so suitable to a limited extent only.

7.3 Order Designations for Thread Reducing Fittings on the Terminal Box

All IndraDyn A motors which are connected to power via a terminal box are delivered with the reducing adapters required for the cable connecting threads ex works.



The thread reducing fittings are provided in the terminal box and are part of the motor delivery.

To order additional reducing fittings, please use the following order numbers:

Reducing fitting	Order number
From M32x1.5 to M25x1.5	R911311878
From M40x1.5 to M25x1.5	R911310332
From M40x1.5 to M32x1.5	R911310197
From M50x1.5 to M25x1.5	R911311279
From M50x1.5 to M32x1.5	R911311876
From M50x1.5 to M40x1.5	R911311880

Fig. 7-5: Thread reducing fittings for terminal boxes

8 Connection Methods

8.1 Notes

NOTICE

The motors may be destroyed by direct connection to the 50/60 Hz supply network (three-wire or single-phase network).

The motors described herein may only be operated with the appropriate drive controllers with variable output voltage and frequency (converter mode) as specified by Rexroth.



Supplementary descriptions and important additional information on how to connect motors in Ex-pxd type design are provided in the operating instructions of the Ex-type motors. The order designation of these operating instructions is DOK-MOTOR*-IDYN*A*EXPD-IBxx-EN-P, MNR R911323996 (DE) and R911323997 (EN).

System functionality and operational reliability are only ensured when Rexroth components are used. Rexroth offers a wide range of ready-made cables and connectors which are optimally adapted to match the products and meet a variety of requirements.

The power wire cross-section was rated for cables by current carrying capacity according to VDE 0298-4 and laying type B2 according to EN 60204-1 at an ambient temperature of 40 °C.

Rexroth ready-made cables have the following essential benefits:

- Pre-wired without requiring additional finishing
- Designed for continuous alternating bending stress
- Resistant against mineral oils, greases and biological oils; free from silicone and halogen; low adhesion
- Use of cables approved according to US and CSA
- Burning behavior complies with VDE 0472-804 requirements
- Compliance of EMC directives
- Degree of protection up to IP 67

Power cables and power plugs are not included in the scope of delivery of the motor and must be ordered separately.

Additional information ...

- on how to select **power and encoder cables** can be found in "Rexroth Connection Cables IndraDrive und IndraDyn", MNR R911322948 (DE) and MNR R911322949 (EN);
- on how to connect IndraDyn A motors in **Ex-pxd type design** can be found in the operating instructions of the Ex-type motors with order designation DOK-MOTOR*-IDYN*A*EXPD-IBxx-EN-P, MNR R911323996 (DE) and R911323997 (EN);
- can be found in the documentation "Electromagnetic Compatibility (EMC) ...", MNR R911259740.

Connection Methods

8.2 Power Connection

8.2.1 General Information

IndraDyn A motors are connected to power on their upper side, either via

- flange socket or
- terminal box

depending on the motor type.

Please also observe the information in the type code of the particular motor.

8.2.2 Additional Ground Conductor on Motors

Source: Rotating electrical machines - DIN EN 60034-1

Pursuant to EN 60034-1:2004 (11.1 Grounding of machines), motors of frame size MAF225C-0150 must be grounded with an additional ground conductor having a wire cross-section of at least 25 mm².

To achieve this, the motor flange is provided with a connection screw with an M12 thread. Use this connection screw to attach the additional ground conductor to the motor by means of a ring terminal for M12 threads and connect the cable to the ground bus in the control cabinet.

8.3 Power Connection with Flange Socket

8.3.1 Motors with Flange Socket

MAD/MAF ...	Flange socket	Coupling	Terminal range [mm ²]	Current carrying capacity
100	INS480	INS048x	1.5 ... 10	max. 41 A
130 ... 160	INS380	INS038x	6 ... 35	max. 100 A
180 ... 225	Not available	-/-	-/-	-/-

Fig. 8-1: Overview of motors with flange socket

Ready-made Rexroth power cables with coupling for connection of IndraDyn A motors feature a bayonet lock.

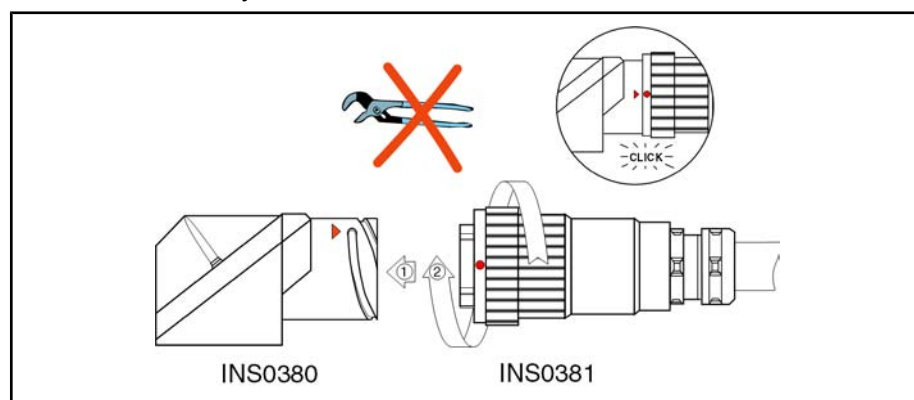
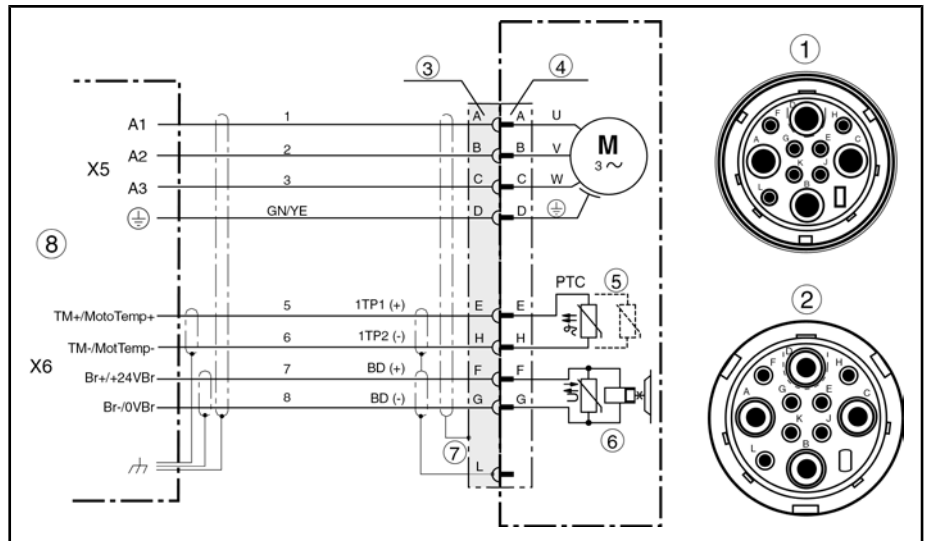

Fig. 8-2: Power plug connection

Proceed as follows to connect motors with connector socket:

1. Push the coupling into the flange socket and observe the coding.
2. Manually tighten the union nut until it you can hear it click into place.
3. The marker points on the coupling and the flange socket must be opposite to each other with the bayonet lock clicked into place.

8.3.2 Connection Diagram



- ① Flange socket INS480 (view of plug-in side)
- ② Flange socket INS380 (view of plug-in side)
- ③ Coupling
- ④ Flange socket
- ⑤ Only one PTC sensor is applied (spare sensor lines are in the socket housing)
- ⑥ Holding brake (optional)
- ⑦ Overall shield connection by clamping the cables of the strain relief in the connector
- ⑧ Connection designations on the Rexroth drive controller

Fig. 8-3: Power connection via connector socket, connection diagram

8.4 Power Connection with Terminal Box

8.4.1 Overview of Motors with Terminal Box

Motor frame size MAD/MAF ...	Terminal box (option D, E, G, H)				
	Designation	U-V-W	Terminal range [mm ²]	Ø PE	Connection thread Cable gland
100	RLK1200	WEF ¹⁾	1.5 ... 16	RT ²⁾ for M8 thread	See information in fig. 8-5 "Connection thread of cable gland at terminal box" on page 210
130	RLK1300	WEF	1.5 ... 35	RT for M8 thread	
160	RLK1300	WEF	1.5 ... 35	RT for M8 thread	
180	RLK1400	RT for M12 thread	1.5 ... 50	RT for M12 thread	
225	RLK1500	RT for M12 thread	1.5 ... 70	RT for M12 thread	

1) WEF = wire end ferrule

2) RT = ring terminal

Fig. 8-4: Overview of motors with terminal box

8.4.2 Cable Connecting Thread on Terminal Box



Cables are screwed to the terminal box via adapter plates and, if necessary, thread reducing fittings. These components are included in the motor delivery. If necessary, however, they can also be reordered separately.

Connection Methods

Motor	Terminal box	Cable gland connection thread	Adapter plate material number
MAD/MAF100x-...	RLK1200	1 x M32x1.5	R911324549
MAD130x-...	RLK1300	1 x M32x1.5	R911324551
MAF130B-...		1 x M40x1.5	R911324552
MAF130C-...			
MAF130D-0050/0100/0150-...			
MAF130D-0200/0250-...		2 x M40x1.5	R911324552
MAD160B-...			
MAD160C-0050/0100/0150-...		1 x M32x1.5	R911324551
MAF160B-0050/0100-...		1 x M40x1.5	R911324552
MAF160C-0050-...			
MAD160C-0200-...			
MAF160B-0150/0200-...		2 x M40x1.5	R911324552
MAF160C-0100/0150/0200-...			
MAD180C-0050-...	RLK1400	1 x M32x1.5	R911324551
MAF180C-0050-...		1 x M40x1.5	R911324552
MAD180C-0100/0150/0200-...			
MAF180C-0100/0150/0200-...		2 x M40x1.5	R911324552
MAD180D-0050-...			
MAF180D-0050-...		1 x M32x1.5	R911324551
		1 x M40x1.5	R911324552
MAD180D-0100/0150/0200-...			
MAF180D-0100/0150-...		2 x M40x1.5	R911324552
MAF180D-0200-...		2 x M50x1.5	R911324553
MAD/MAF225C-...	RLK1500	2 x M50x1.5	R911324554

Fig.8-5: Connection thread of cable gland at terminal box

8.4.3 Connection Diagram

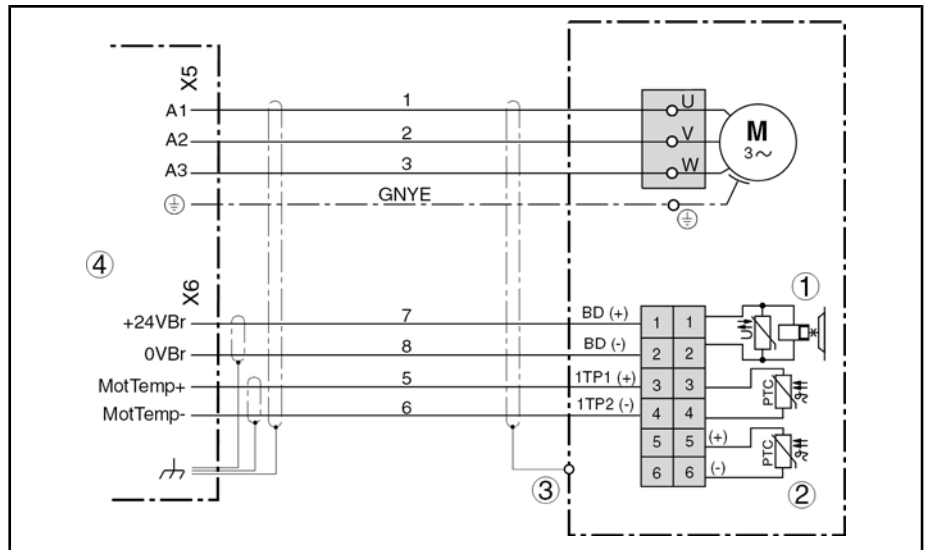

- ① Holding brake (optional)
- ② Spare temperature sensor (connect spare sensor lines only if necessary)
- ③ Shield connection by clamping the cables of the strain relief in the cable gland
- ④ Connection designations on the Rexroth drive controller

Fig. 8-6: Terminal box connection diagram



- Brake connections 1-2 are only assigned if the motor is manufactured with the optional brake.
- Only one contact pair of PTC thermistor connections 3-4 and 5-6 is connected to the motor cable.
- The seal which is glued into the lid at the factory may not be detached or damaged.
- Please observe the size of the cable gland and the connection thread when leading the cables into the terminal box.
- Make particularly sure that the connecting cables are placed orderly and without strain in the terminal box to prevent rubbing or pressure marks on the cables.
- The connections of the internal winding interconnection in the terminal box may not be detached.

Connection Methods

8.4.4 Terminal Box Details

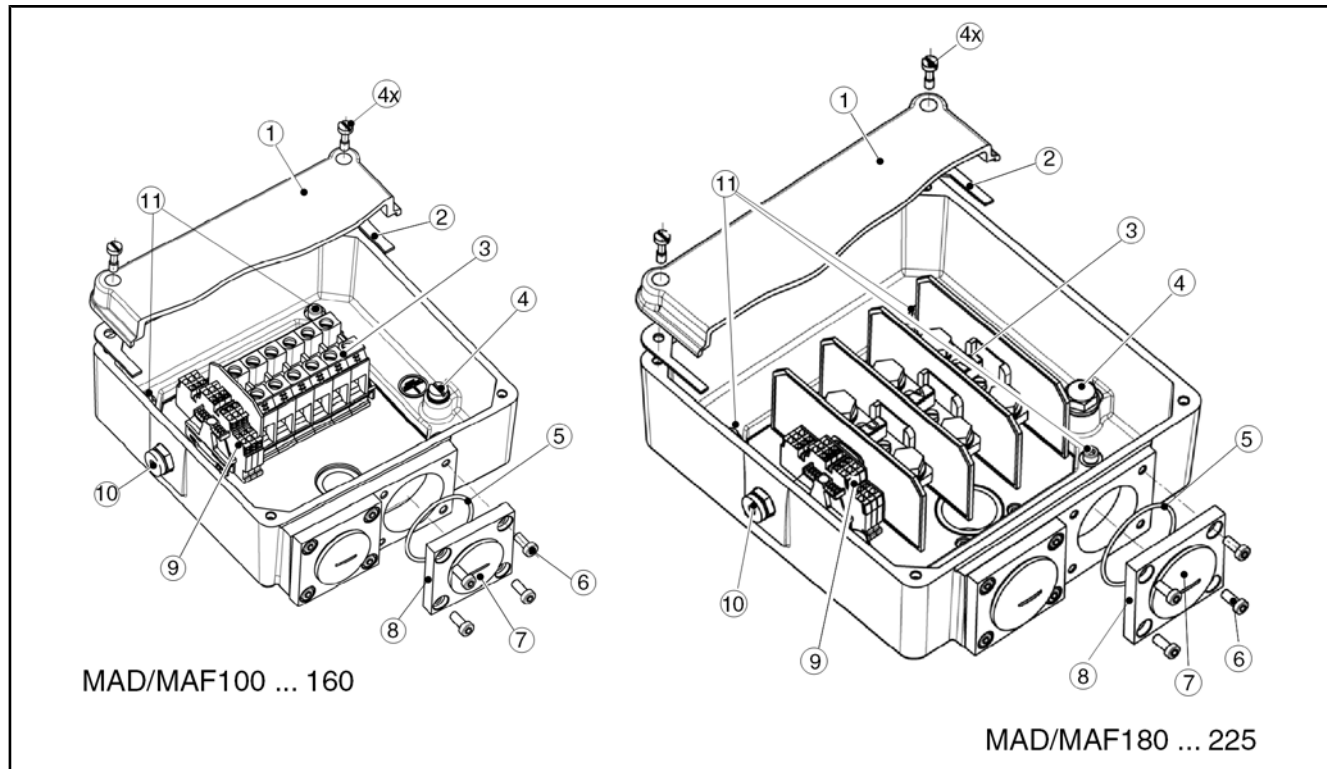

- | | |
|---|--|
| ① | Lid |
| ② | Seal |
| ③ | Terminal block U-V-W |
| ④ | PE connection |
| ⑤ | O-ring |
| ⑥ | Adapter plate mounting screws |
| ⑦ | Safety cover of the cable gland connection thread (for connection thread size, see fig. 8-5 "Connection thread of cable gland at terminal box" on page 210) |
| ⑧ | Adapter plate for cable gland |
| ⑨ | Terminal strip (brake, temperature sensor) |
| ⑩ | Purging gas connection (only applicable to Ex-type motors) |
| ⑪ | Clamping screws for setting the outgoing cable direction (4 pcs.) |
- Fig. 8-7: Terminal box details*

8.4.5 Power Connection

Power cable connection on terminal box

The outgoing direction required for the power cable is selected in the type code of the motor. The terminal box is mounted to the motor at the factory, based on the outgoing direction defined by the user.



When selecting the "rotating terminal box" connection option, the user can adjust the outgoing cable direction to new or changed connection conditions directly at the place of use and at any time, simply by "rotating" the terminal box.

Proceed as follows to connect the power cable to the terminal box:

1. Open the terminal box lid ①.
Unscrew and remove the mounting screws (4 pcs.).

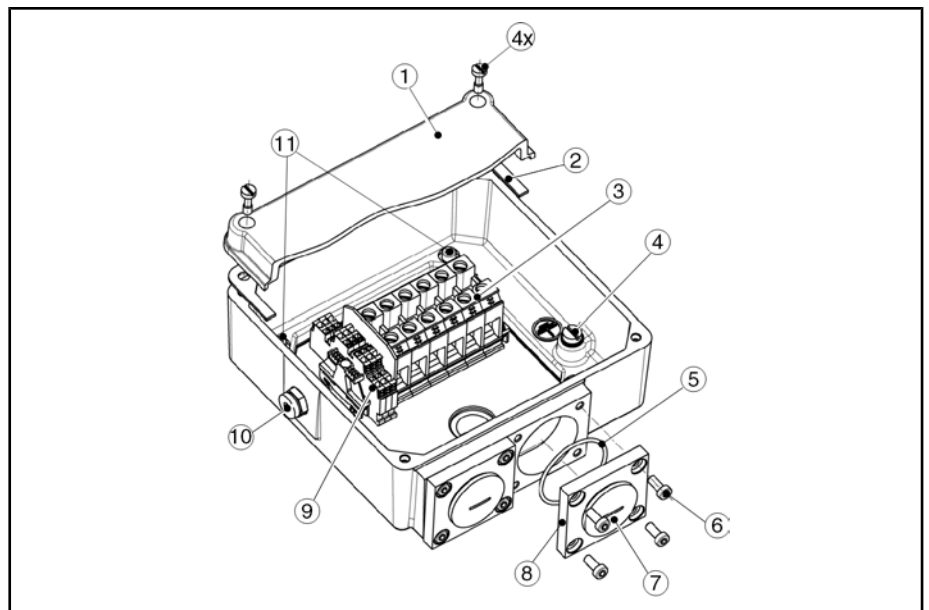

- | | |
|---|---|
| ① | Lid |
| ② | Seal |
| ③ | Terminal block U-V-W |
| ④ | PE connection |
| ⑤ | O-ring |
| ⑥ | Adapter plate mounting screws |
| ⑦ | Safety cover of the connection thread of the cable gland |
| ⑧ | Adapter plate for cable gland |
| ⑨ | Terminal strip (brake, temperature sensor) |
| ⑩ | Purging gas connection (only applicable to Ex-type motors) |
| ⑪ | Clamping screws for setting the outgoing cable direction (4 pcs.) |

Fig.8-8: Rotating terminal box (option D, E, G, H)

2. Check the outgoing cable direction and rotate the terminal box if necessary.
 - Detach the terminal box.
 Unscrew the mounting screws ⑪ and rotate the terminal box by 90 to max. 180 degrees to the desired outgoing direction.
 - Attach the terminal box.
 Screw in the mounting screws ⑪ and tighten them.
 Tightening torque of the screws ⑪: 6.5 Nm (±10%)

WARNING! Improperly inserted or missing seals may lead to loss of the motor protection and to explosion hazard of Ex-type motors.
 ⇒ There is a seal between the terminal box and the motor housing. After having rotated or retightened the terminal box, check it to verify that the seal is in a proper state and in its correct position.
3. Turn out the safety cover of the cable gland ⑦.
4. Detach the adapter plate ⑧ from the terminal box.
5. Firmly secure the adapter plate to the metric cable gland on the power cable.

Connection Methods

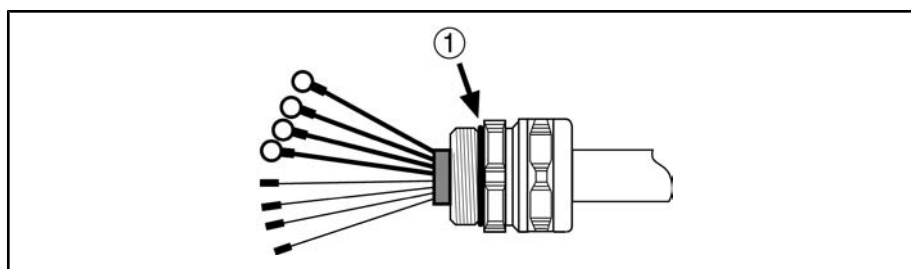

① O-ring position

Fig.8-9: O-ring on cable gland

WARNING! Improperly inserted or missing O-rings may lead to loss of the motor protection and to explosion hazard of Ex-type motors.

⇒ Before attaching the adapter plate to the power cable, visually check the O-ring on the cable gland of the power cable to verify its proper state and correct position. Do not use the power cable if the O-ring is missing. In this case, please contact your local Rexroth sales or service partner.

6. Run the power cable to the adapter plate through the opening into the terminal box and reattach the adapter plate to the terminal box.

Tightening torque of the screws ⑥: 9 Nm ($\pm 10\%$)

WARNING! Improperly inserted or missing O-rings may lead to loss of the motor protection and to explosion hazard of Ex-type motors.

⇒ Before attaching the adapter plate ⑥ to the terminal box, check the O-ring ⑤ inserted into the adapter plate to verify its proper state and correct position.

7. Connect the wires according to the standard or double cabling connection diagram.

Please observe the following tightening torques:

Screw tightening torques in Nm ($\pm 10\%$) for MAD/MAF power connection to terminal boxes of "D, E, G, H" design

Terminal box to	U-V-W		PE	
	M6	M12	M8	M12
MAD/MAF100 ... 160	2.5	- / -	3.5	- / -
MAD/MAF180 ... 225	- / -	14	- / -	20

Fig.8-10: Screw tightening torques in Nm in "D, E, G, H" terminal box

8. Close and attach the terminal box lid.

Apply Loctite 243 (liquid screwlock) to the thread of the mounting screws for the lid ① and then attach the lid with all of the mounting screws.

Tightening torque of the screws: 6.5 Nm ($\pm 10\%$)

WARNING! Improperly inserted or missing seals may lead to loss of the motor protection and to explosion hazard of Ex-type motors.

⇒ Before attaching the lid to the terminal box, check the glued-in seal ② on the terminal box lid to verify its proper state and correct position.

8.5 Double Cabling

Motor connection requires two power cables if an appropriate single cable cannot be used because of the large bending radius or because of its dimensions.



The following connection diagram shows a proposed circuit. When designing the double cabling, observe the installation regulations applicable at the place where the machine is set up.

Double cabling connection diagram

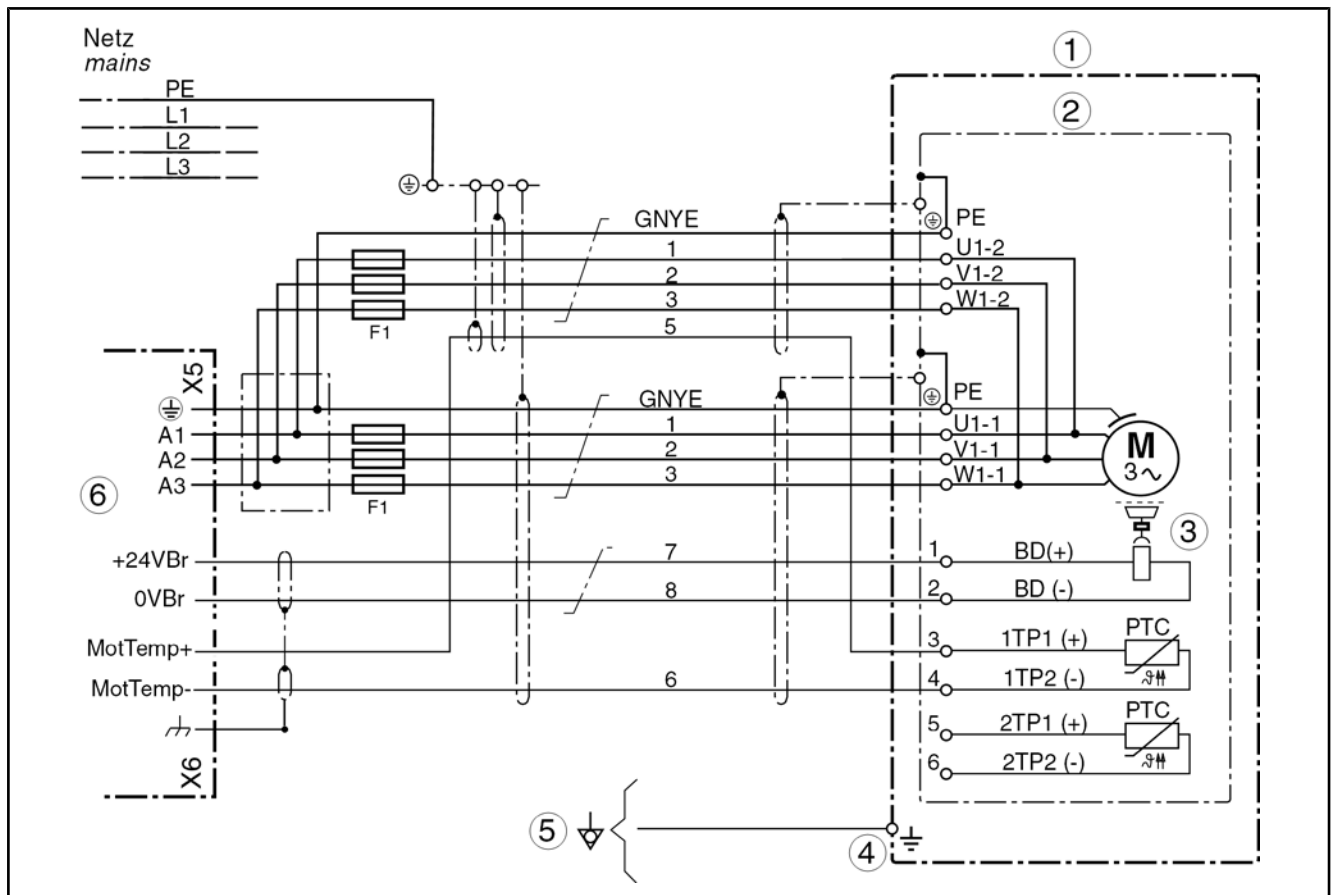

- ① Motor housing
- ② Terminal box
- ③ Holding brake (optional)
- ④ Potential equalization connection at the motor (only available on MAF225C-0150 and Ex-type motors)
- ⑤ Potential equalization connection at the machine (required for MAF225C-0150 and Ex-type motors)
- ⑥ Rexroth drive controller

Fig. 8-11: Double cabling connection diagram

Connection Methods



- The double cabling is only possible for the power connection by means of the terminal box.
- Fuses F1 (NH...) protecting the wires against overload in case of a cable break must be dimensioned according to the current carrying capacity of the particular line cross-section.
- The fuses should be installed in the control cabinet as closely to the power output of the controller as possible.
- The shield of the motor power cable must be connected to the control cabinet on the motor side of the fuses such that it is conducting over a large area.
- Power cables are not available to establish the double cabling. Rexroth standard power cables must be stripped, separated into their wires and converted appropriately on site to allow installation of the fuses.

8.6 Encoder Connection

Depending on the encoder type, the encoder connection of IndraDyn A motors is designed as 10-pin, 12-pin or 17-pin connector socket on the motor housing.

Motor	Frame size	Flange socket (X3) for encoder connection	
		M2 / S2 M6 / S6	C0
MAD	100	RGS1003	INS0629
	130 ... 225	RGS1004 *)	INS0719
MAF	100 ... 225	RGS1003	INS0629

*) Flange socket RGS1004 cannot be ordered as a single component. It is an integral part of the encoder connecting cable for connecting encoder option M2/S2.

Fig. 8-12: Encoder flange socket designations

The following couplings can be used on the connecting cable in connection with the connector sockets specified:

Flange socket (X3)	Coupling
INS0629	INS0379
INS0719	INS0379
RGS1003	RGS1001
RGS1004 *)	RGS1001

*) Flange socket RGS1004 cannot be ordered as a single component. It is an integral part of the encoder connecting cable for connecting encoder option M2/S2.

Fig. 8-13: Couplings for encoder flange sockets

The following table shows the pin assignments.

Pin assignment for encoder options
 M2/S2 and M6/S6

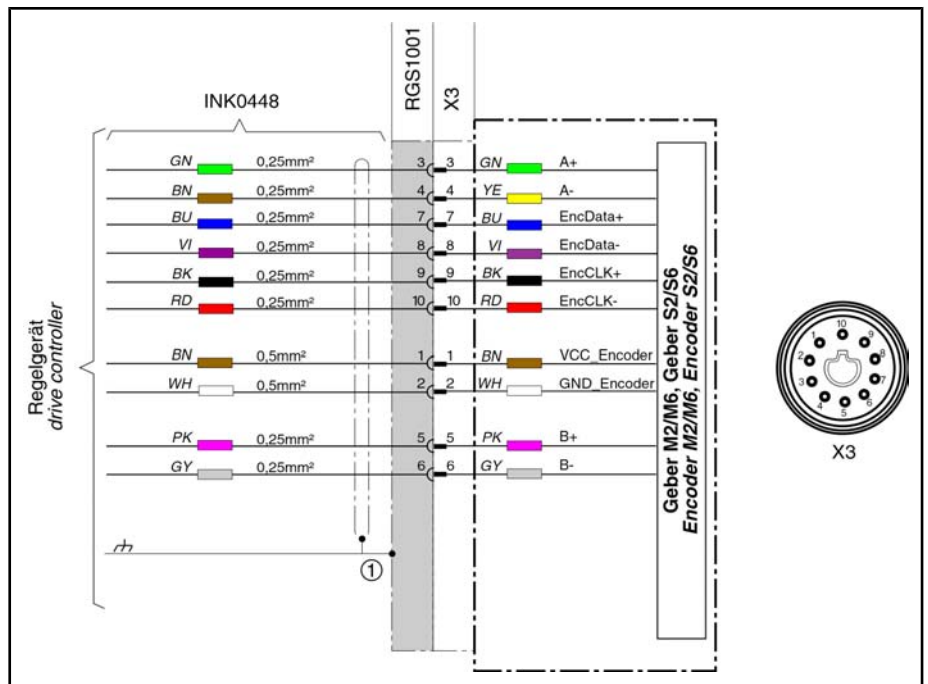

① The shield is clamped to the strain relief.
 Fig. 8-14: Connecting encoder types M2/S2 and M6/S6

Pin assignment for encoder option
 C0

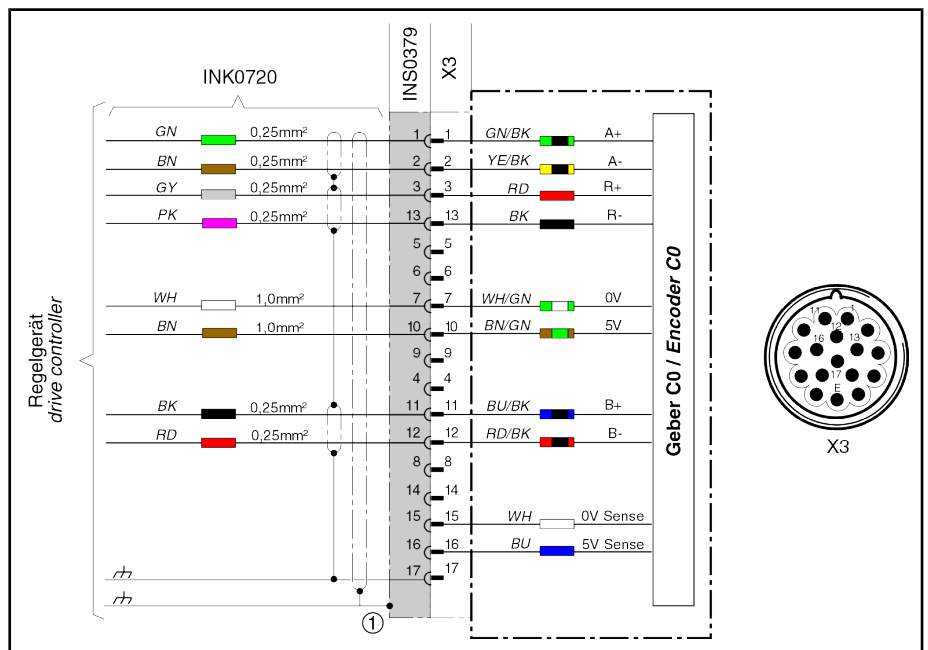

① The shield is clamped to the strain relief.
 Fig. 8-15: Connecting encoder type C0

The cable connecting the motor encoder to the controller must be provided with a compatible coupling on the motor side.

The motor-sided connector socket and the cable-sided coupling must be fitted onto each other and screwed to each other manually. Their structure is therefore mirror-inverted, i.e., they have a different "pole image".

Observe the mechanical coding.

Connection Methods

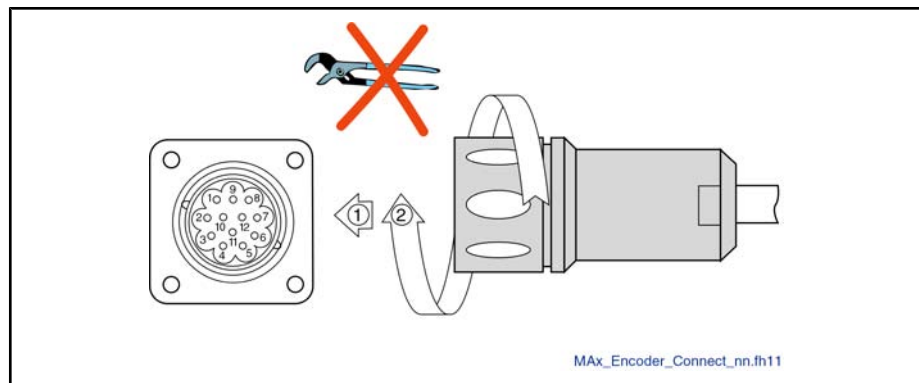

Fig. 8-16: Example encoder plug connection

1. Push the coupling into the flange socket and observe the coding.
2. Manually tighten the union nut.

8.7 Temperature Sensor

IndraDyn A motors feature two PTC temperature sensors **KTY84-130** which are permanently installed in the motor winding. For additional information on the temperature sensor, please refer to [chapter 9.9 "Motor Temperature Monitoring" on page 237](#).



- Before reconnecting the sensor, initiate ESD protection measures (ESD = electrostatic discharge).
- If the sensor is to be used externally for temperature measurement, proper polarity must be ensured when it is connected.
- For connection diagrams, see [fig. 8-3 "Power connection via connector socket, connection diagram" on page 209](#) and [fig. 8-6 "Terminal box connection diagram" on page 211](#) at the beginning of this chapter.

8.8 Holding Brake

The motor holding brake is activated either directly by the controller or externally.



- For connection diagrams, see [fig. 8-3 "Power connection via connector socket, connection diagram" on page 209](#) and [fig. 8-6 "Terminal box connection diagram" on page 211](#) at the beginning of this chapter.
- The control voltage is +24 V_{DC} (+/-10%).
- Please note that there are functional differences between electrically clamping and electrically releasing brakes (see [chapter 9.10.3 "Selecting Holding Brakes" on page 240](#)).

8.9 Motor Cooling

8.9.1 Fan Connection

The motor fan is connected to the supply network via a cable and a motor protective switch and is operated independently of the controller.

Connection Methods

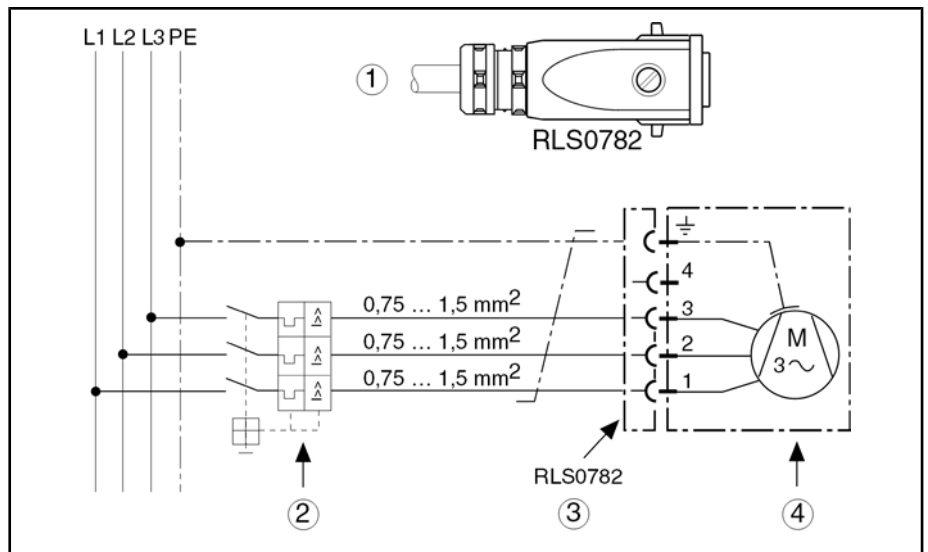

- ① Power connection cable diameter $\varnothing 7 \dots 10$ mm
- ② Protective switch
- ③ Plug connector
- ④ Fan

Fig. 8-17: Fan connection



- To connect the motor fan, the fan connector must be opened and closed.
- Electric connection may only be established by specialized staff. Observe the safety-related guidelines.
- The tightness of the connector housing may not be reduced.
- Motor protective switch and electric fusing are selected by the machine manufacturer. Follow the regulations applicable in the country where the machine is set up.
- The connector for connecting the motor fan is included in the scope of delivery and is located on the motor fan.

8.9.2 Coolant Port

The following coolant ports can be selected for motors with liquid cooling:

- Coolant port via the connection thread on the motor
- Coolant port via quick couplings



The inlet (IN) and outlet (OUT) can be assigned as desired. The assignment does not have any effect on the performance data of the motor.

Connection Methods

Coolant port thread

Motor MAF ...	Connection via ...		Remark
	Thread	Quick coupling [Ø d _i tube]	
100 ... 130	G1/4"	9 mm	Select connection according to type code
160 ... 225	G1/2"	13 mm	

Fig.8-18: Overview of coolant ports

The connection threads on the motor are covered with protective plugs at the factory. These protective plugs may only be removed immediately before screwing in the coolant lines or the quick coupling to prevent dirt from entering into the cooling system.

The following table shows the loads allowed for the motor-sided connection threads.

Frame size MAF ...	Connection thread	Max. allowed screw-in depth [mm]	Max. allowed tightening range [Nm]
100 ... 130	G1/4"	14	18 ... 20
160 ... 225	G1/2"	18	27 ... 30

Fig.8-19: Coolant port thread, allowed tightening torques and screw-in depths

NOTICE

The coolant port threads on the motor may be destroyed by incorrect tightening torques!

The allowed motor connection tightening torque may not be exceeded! If the tightening torque or screw-in depth is exceeded, the motor may be damaged irreversibly.

The motor-sided coolant ports are provided for coolant port connections with axial seal.

Bosch Rexroth therefore recommends to use screw connections which already contain an O-ring for sealing the screw connection in axial direction.

For example, seals consisting of hemp, teflon tape or cone-shaped screw connections are not considered to be suitable because this type of seal may stress the connection thread on the motor to an unreasonably high extent and/or damage it permanently.



The machine manufacturer is responsible for ensuring that the coolant port is tight and for verifying and accepting this tightness after the motor has been installed.

Moreover, the maintenance schedule of the machine should provide for a regular check of the proper state of the cooling port.

Quick coupling

It is also possible to use a quick coupling for the coolant port. The quick coupling features leak protection on either side and can be released even under full pressure.

If a motor with this type of coolant port is ordered, all quick coupling parts are included in the motor delivery. Based on the ambient conditions of the motor, the user can select from two quick coupling mounting methods.

1. **Method A:** Lock nipple mounted on the motor side

2. **Method B:** Coupling mounted on the motor side

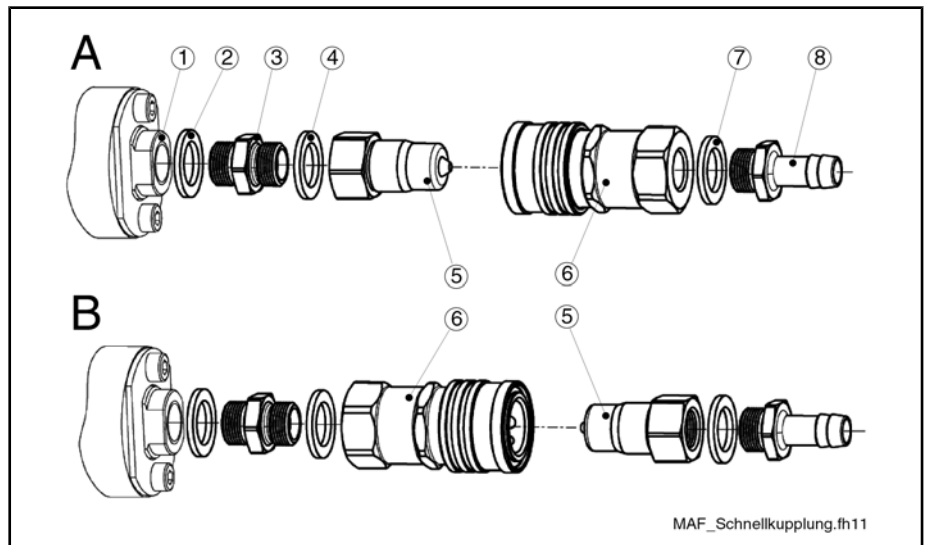

- ① Connection thread on the motor
- ②④⑦ Seal
- ③ Double nipple
- ⑤ Lock nipple
- ⑥ Coupling
- ⑧ Threaded adapter for tube

Fig. 8-20: Quick coupling mounting methods



Connect the double nipple to the coupling or the lock nipple. Then screw the double nipple into the connection thread on the motor. This procedure prevents the connection thread in the motor from being stressed repeatedly.

When mounting the quick coupling, ensure

- that the seals are correctly positioned,
- that the following tightening torques between the individual coupling components are kept,

Quick coupling thread size	Allowed tightening range [Nm] between the components of the quick coupling
1/8" ... 1/4"	23 ... 25
1/2"	28 ... 30

Fig. 8-21: Allowed tightening torque of the quick coupling

- that the allowed screw-in depths and tightening torques at the motor are kept.

Frame size MAF ...	Connection thread	Max. allowed screw-in depth [mm]	Allowed tightening range [Nm]
100	G1/8"	14	14 ... 15
130	G1/4"	14	18 ... 20
160 ... 225	G1/2"	18	27 ... 30

Fig. 8-22: Coolant port thread, allowed tightening torques and screw-in depths

When selecting the coolant tube, ensure you use the required inside tube diameter d_i according to [fig. 8-18 "Overview of coolant ports" on page 220](#).

Connection Methods

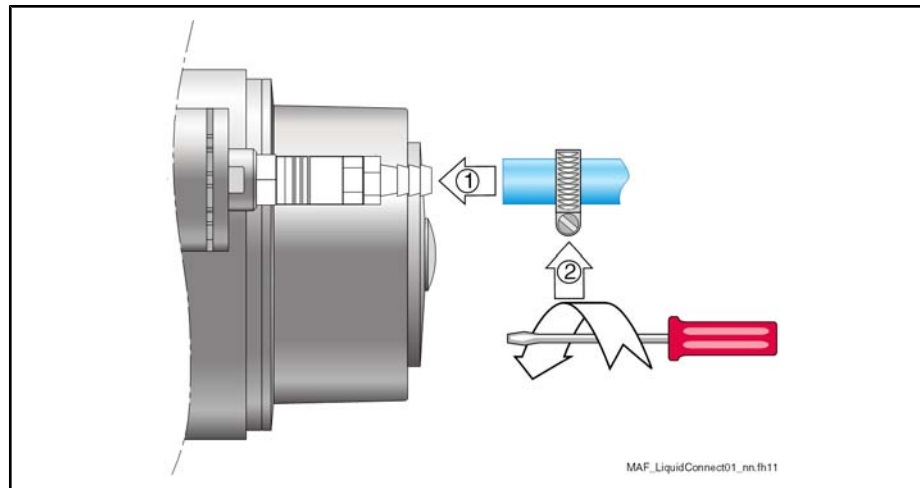

Fig.8-23: Connecting the coolant tube (example)

When mounting the coolant tube, proceed as follows:

1. Remove the protective caps from the coolant port threads on the motor and screw in the pre-assembled quick coupling.
2. Push the tube onto the connection piece (threaded adapter). Do not bend or damage the motor-sided screw connection.
3. Screw the tube end with the mounting clamp tightly above the connection piece.
 - In service cases, the quick coupling can be disconnected from the lock nipple by means of the coupling. It is not necessary to disconnect the tube connection.

If a different connection method is used on the tube side, other mounting steps may be required. Mounting instructions can be obtained from the manufacturer.



To supply MAF motors with coolant, other installation materials are also required, for example, tubes and mounting clamps (these are not included in the scope of delivery).

8.9.3 Coolant Input Pressure

The maximum coolant input pressure for all MAF motors which were manufactured prior to 2008-07-01 is **3 bar**, in relation to the pressure which is effectively present directly at the coolant port of the motor. A coolant input pressure of **6 bar** at the coolant port is allowed for all motors manufactured after this date.

Please note that additional screw connections or branches in the cooling circuit may have adverse effects on the flow and supply pressure of the cooling medium.

9 Application Guidelines

9.1 Operating Conditions

9.1.1 Installation Altitude and Ambient Air Temperature

The motor performance data specified are applicable for

- ambient air temperatures ranging from 0 °C to +40 °C,
- installation altitudes ranging from 0 m to 1000 m above sea level.

The performance data of motors used outside of the above ranges is reduced according to the following figure.

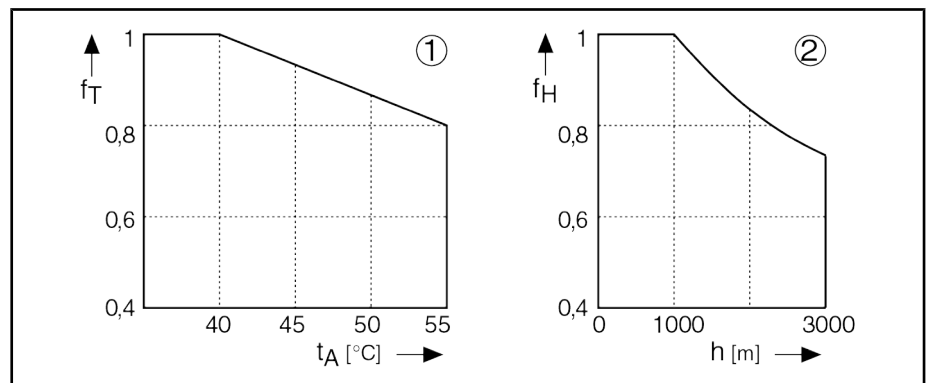

- ① Usability to capacity, depending on the ambient air temperature
- ② Usability to capacity, depending on the installation altitude
- f_T Temperature utilization factor
- t_A Surrounding air temperature in degrees Celsius
- f_H Altitude utilization factor
- h Installation altitude in meters

Fig.9-1: Utilization factors

If **either** the surrounding air temperature **or** the installation altitude is above the nominal data:

1. Multiply the motor data specified in the technical data by the determined utilization factor.
2. Ensure that your application does not exceed the reduced motor data.

If **both** the ambient air temperature **and** the installation altitude are above the nominal data:

1. Multiply the determined utilization factors f_T and f_H.
2. Multiply the resulting value by the motor data specified in the technical data.
3. Ensure that your application does not exceed the reduced motor data.

Application Guidelines

9.2 Humidity

Climatic environmental conditions are classified according DIN EN 60721-3-3 Table 1. They are based on long-term experiences and take all influencing variables into account, e.g., air temperature and air humidity.

IndraDyn A motors may be continuously operated within the limit ranges of class 3K4. The following table contains extracts from this class.

Environmental factor	Unit	Class 3K4
Lower air temperature	°C	+5 ¹⁾
High air temperature	°C	+40
Low relative humidity	%	5
High relative humidity	%	95
Low absolute humidity	g/m ³	1
High absolute humidity	g/m ³	29
Temperature change rate	°C/min	0.5

1) The lowest air temperature allowed by Rexroth is 0 °C.

Fig.9-2: Classification of climatic environmental conditions according to DIN EN 60721-3-3, Table 1

9.3 Vibration and Shock

9.3.1 Vibration

Vibrations are sine-wave oscillations in stationary use, which vary in their effect on the resistance of the motors depending on their intensity. The resistance of the overall system is determined by the weakest component.

Based on DIN EN 60721-3-3 and DIN EN 60068-2-6, the following values are allowed for Rexroth IndraDyn A motors:

Direction	Maximum allowed vibration load
	10 – 2,000 Hz
Axial	10 m/s ²
Radial	30 m/s ² (10 m/s ² in connection with M2/M6 and S2/S6 encoders)

Fig.9-3: Maximum values for sine-wave oscillations

The construction and effectiveness of vibration-damping or vibration-decoupling attachments depend on the particular case of use and must be determined in a measurement setup. They are not the motor manufacturer's responsibility. Changes in motor construction will invalidate the warranty.

9.3.2 Shock

The shock load of the motors is defined by the maximum allowed acceleration in non-stationary use, e.g., during transport.

Function-impairing effects are avoided as long as the limits specified are kept. Based on DIN EN 60721-3-3, the following values are applicable for IndraDyn A motors:

Motor frame size	Maximum allowed shock load (duration 6 ms)	
	Axial	Radial
100 ... 225	10 m/s ²	150 m/s ²

Fig.9-4: Shock load



Please also observe the information provided in [chapter 10 "Handling and Transport"](#) on page 271.

9.4 Compatibility Test

All Rexroth controls and drives are developed and tested according to the latest state-of-the-art of technology.

As it is impossible to follow the continuing development of all materials (e. g. lubricants in machine tools) which may interact with our controls and drives, it cannot be completely ruled out that any reactions with the materials used by Bosch Rexroth might occur.

For this reason, before using the respective material a compatibility test has to be carried out for new lubricants, cleaning agents etc. and our housings / our housing materials.

9.5 Degree of Protection

IndraDyn A motors are subject to the degrees of protection pursuant to IEC 60529. It must always be ensured that the motors - irrespective of their installation position - are not exposed to ambient conditions outside of the applicable degree of protection.

The degree of protection is defined by the short symbol IP (International Protection) and two code numbers. The first code number stands for the degree of protection against contact and ingress of foreign bodies, the second one stands for the degree of protection against ingress of water.

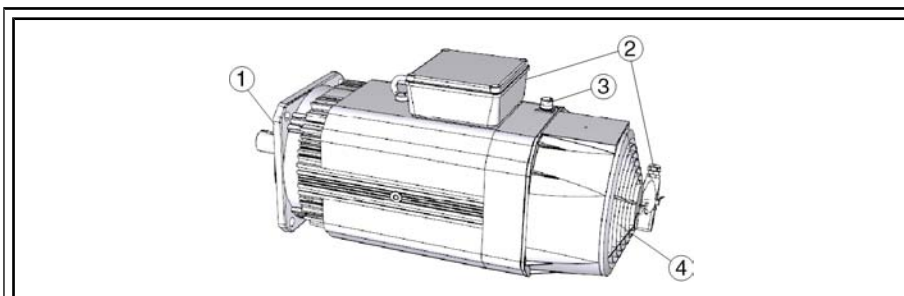

Fig.9-5:

Component subject to protection		Degree of protection	Remark
①	Output shaft without shaft sealing ring	IP 54	IP 40 with vertical installation position (see chapter 9.6.3 "Vertical Installation Positions" on page 229)
	Output shaft with shaft sealing ring	IP 65	Optional (see chapter 9.12.3 "Output Shaft with Shaft Sealing Ring" on page 245)
	Output shaft with labyrinth seal	IP 65	Optional (see chapter 9.12.4 "Output Shaft with Labyrinth Seal" on page 246)
②	Power connection Fan connection	IP 65	Terminal box or plug
③	Motor encoder connector	IP 65	
④	Motor fan	IP 65	Fan motor IP 65 Fan grille IP 24

Fig.9-6: Definition of degrees of motor protection

Products and components with low degree of protection are not suitable for cleaning procedures using high pressures, vapor or water jet.

NOTICE

Ingressing fluid may damage the motor!

Fluids (e.g., cooling lubricants, gear oil, etc.) may not be present at the output shaft. If, e.g., gears are attached, only gears with a closed (oil-tight) lubrication system may be used.

9.6 Frame Shape and Installation Position

9.6.1 General Information

IndraDyn A motors are available in frame shapes B05 and B35. The installation types allowed according to EN 60034-7 are shown in the following table.

Motor frame shape	Allowed installation types		
	Designation	Sketch	Installation
B05	IM B5		Flange attachment on the drive side of the flange
	IM V1		Flange attachment on the drive side of the flange, drive side facing down
	IM V3		Flange attachment on the drive side of the flange, drive side facing up
B35	IM B3		Foot assembly, feet at the bottom
	IM B5		Flange attachment on the drive side of the flange

Fig.9-7: Installation positions

IndraDyn A motors of frame shape B35 can be attached either via foot assembly or flange assembly.

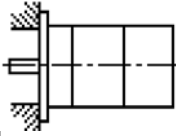
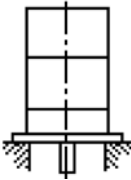
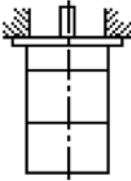
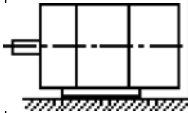
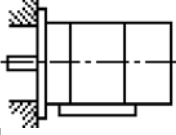
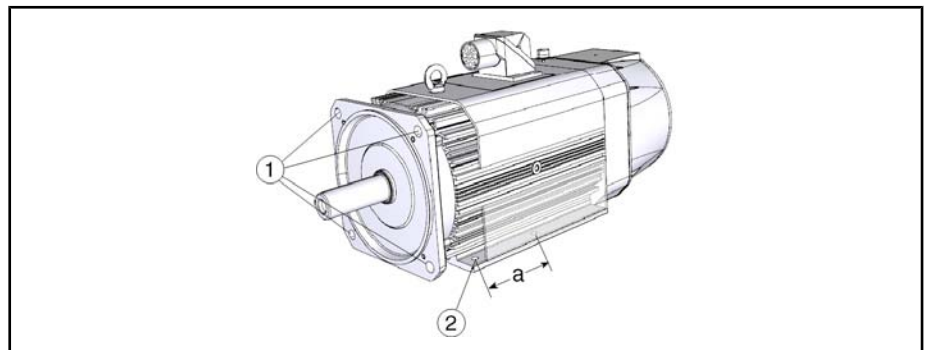

- ① Flange for foot assembly
- ② Mounting foot (on either side)
- a Hole clearance, see motor dimension drawing

Fig.9-8: IndraDyn A motor attachment types

Application Guidelines

9.6.2 Foot Assembly

In contrast to flange assembly, radial forces may only be effective in a direction perpendicular to the mounting surface ($\pm 15^\circ$) if foot assembly is selected. The transmission of forces in other effective directions is not allowed.

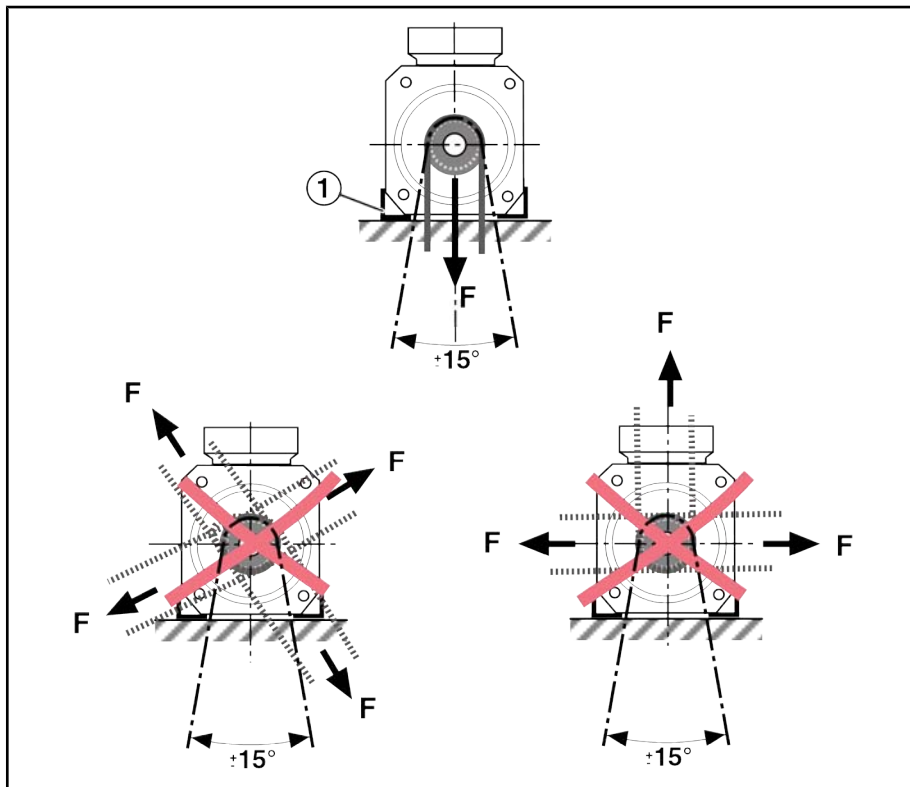

①

Mounting feet

Fig.9-9:

Example: MAF foot assembly



Please note the following in case of foot assembly ...

- Forces which are transmitted by a gearbox and have an effect on the motor feet are not allowed.
Forces taking effect via the gear shaft must be supported against the gearbox.
- Incorrect installation situations give rise to forces which may cause short-term damage to the motors.
- See also the instructions on foot assembly in [chapter 11 "Installation" on page 277](#). If necessary, consider "flange assembly" as an alternative.

9.6.3 Vertical Installation Positions

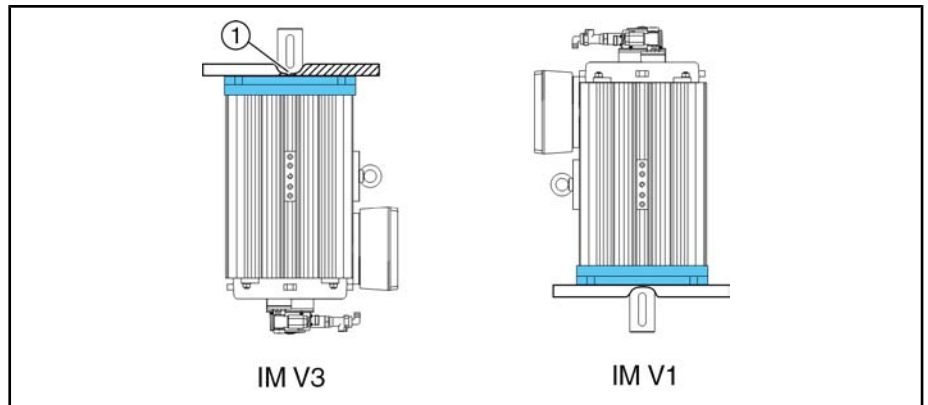

① Shaft gland IP 40 (standard)
 Shaft gland with radial shaft sealing ring IP 65 (optional)

Fig.9-10: Example: vertical MAF installation position



- **Side A:** Motors with shaft sealing ring have IP 65 degree of protection on their flange side. However, tightness is ensured only against incoming splash fluids. Fluid levels present on the output side require a higher degree of protection.
- **Side B:** Grilles in axial fans require degree of protection IP 24. The fan grille allows entry of chips or large dirt particles.
- **Degree of protection:** The factory-set degree of protection of IndraDyn A motors may not be reduced by modifying the motors or retrofitting accessories.

Output shaft at top

If motors are installed vertically with the output shaft positioned at the top ([chapter 9.6.3 "Vertical Installation Positions" on page 229](#)), dirt and fluids can easily enter into the interior of the motor and lead to malfunctions or failures.

Also note that, in this installation position, the axial bearing load (side B) of motors of frame size 225 is so high (due to the heavy rotor weight and the bearing pretension force) that the service life of the bearing must be expected to be clearly reduced to ~30 % of the service life that was determined originally.



If installed vertically with the output shaft positioned at the top, the service life of motors of frame size 225 must be expected to be reduced to **approx. 30%**.

Output shaft at bottom

If motors of frame size 225 are operated in vertical installation position with the output shaft positioned at the bottom and in connection with a coupling, the coupling must be selected such that

- the axial pretension force of the coupling is not higher than **max. 400 N** in the pretensioned state.

9.7 Motor Paint

Color Black (RAL9005)

Resistance Resistant against

- diluted acids/lyes
- water, seawater, sewage

Application Guidelines

- current mineral oils

Resistant to a limited degree against

- organic solvents
- hydraulic oil

Not resistant against

- concentrated acids/lyes

Additional paint**Allowed for:**

Standard products.

The housing may be painted with a coating thickness of no more than 40 µm. Before painting the housing, check the adhesiveness and resistance of the new paint.

NOT allowed for:

Products for potentially explosive atmospheres.

Ex-type motors may not be repainted to ensure that there will be no negative effects on surface properties (e.g., insulation resistance, electrostatic charging).



If motors are repainted, all safety labels, name plates and open plug connectors must be covered to be protected against painting.

9.8 Motor Cooling

9.8.1 Fan

MAD motors may only be operated with a fan. These motors are cooled via air currents which are guided across the surface of the motor by air baffles.

The fan is designed such that it uses clean air from its environment to cool the motor. If the motors are used in heavily soiled or hazardous areas, special precautions must be taken. Please also observe the guidelines in [chapter 9.8.2 "Radial Ventilation in Heavily Soiled or Potentially Explosive Atmospheres"](#) on [page 232](#) in this context.

It is explicitly prohibited to use the fan under the following conditions:

- Delivery of air which contains abrasive particles
- Delivery of air which has a strongly corroding effect, e.g., salt mist
- Delivery of air which contains a high dust load, e.g., extraction of saw dust
- Delivery of combustible gases/particles
- Use of the ventilator as a technical safety component or as a component assuming safety-relevant functions

Axial fan

The fan used is an axial fan. The fan is only available as "blowing" fan. Please observe the data in the type code.

To ensure that the axial fan can move the required air volume, a minimum distance for letting the air in and out must be kept between the fan grille and the machine. This distance is based on the motor construction.

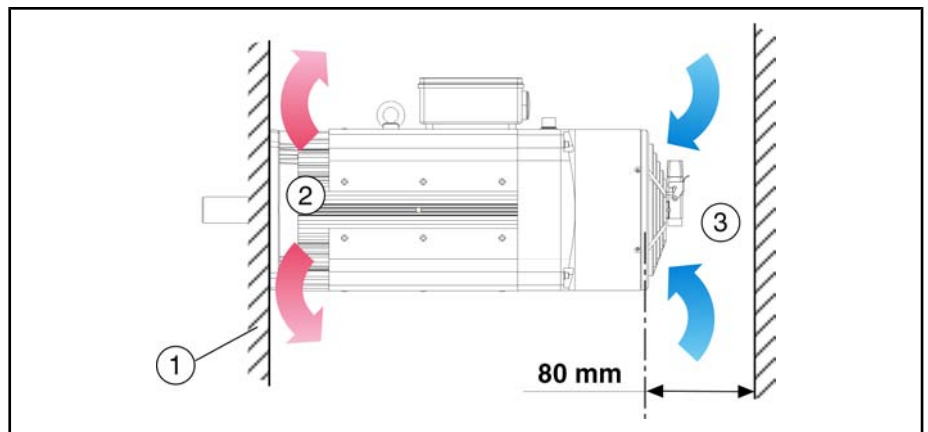

- ① Machine
- ② Air outlet space
- ③ Air inlet space

Fig.9-11: MAD ventilation

- Provide for the minimum distance of the air supply ③ when designing the machine.
- All fans are "blowing" fans.

Dirt and contaminants can reduce the flow rate of the fans and result in a thermal overload of the motors.

When the motors are operated in a dirty environment, the availability of the system is increased by cleaning the fans and motor cooling fins at regular intervals.

When designing the machine, provide for accessibility of the motor and fan for maintenance purposes.

For special instructions on maintenance and troubleshooting of motor fans, please refer to [chapter 12.4.3 "Motor Fan "](#) on page 283.

Application Guidelines

9.8.2 Radial Ventilation in Heavily Soiled or Potentially Explosive Atmospheres

If IndraDyn A motors in Ex-type design are operated in an potentially explosive or heavily soiled atmosphere, clean air for cooling the motor must be supplied from outside via a tube or an air duct.

- In this case, motors with fan cowl and fan shroud (type code option "SL") must be selected to allow connection of an air tube.

Example application

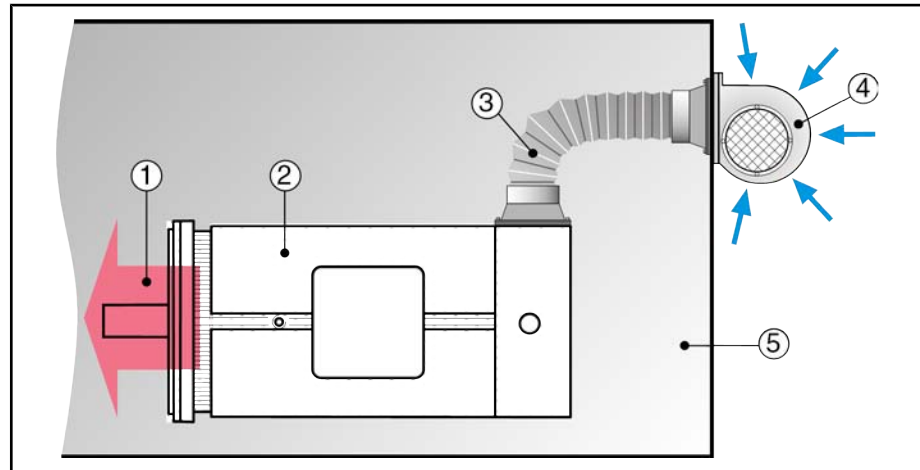

- ① Air outlet
- ② Motor
- ③ Air duct (not included in delivery)
- ④ Air inlet (radial fan not included in delivery)
- ⑤ Working area

Fig.9-12: Example radial ventilation via fan shroud

The machine manufacturer has to select a suitable radial fan while taking the machine specification into account.

In general, radial fans for IndraDyn A motors are not included in the Rexroth scope of delivery.

Fan shroud on MAD...	Diameter for air tube connection (for further details, see motor dimension drawing)
100	Ø 80 mm
130	Ø 100 mm
160 ... 225	Ø 150 mm

Fig.9-13: Connection diameter of fan shroud



After the ventilation system has been installed, a specific air volume flow must be available at the motor (see data on the mean air volume flow in the motor data sheet in chapter 4).

For this reason, the installed tube or air duct length and the type of air supply (straight or bent) must be taken into account when selecting the radial fan or when using central ventilation.

- The machine manufacturer has to calculate the required air flow rate based on the plant specification.
- The air duct and the fan tubes are not included in the Rexroth scope of delivery.

Bosch Rexroth recommends the following manufacturers of powerful radial fans and connection material, such as air tubes, tube clamps, etc.:

Application Guidelines

Source of supply for radial fans	
Elektror airsystems GmbH	Richard-Hirschmann-Strasse 12 73728 Esslingen am Neckar, Germany Phone +49(0)711 319 73- 0 Fax +49(0)711 319 73- 5000 E-mail: info@elektror.de Internet: www.elektror.de
Source of supply for air tubes and connection accessories	
NORRES Schlauchtechnik GmbH & Co. KG	Freiligrathstrasse 38 45881 Gelsenkirchen, Germany Phone +49(0)209 800 00-0 Fax +49(0)209 800 00-71/-72 E-mail: info@norres.de Internet: www.norres.de

Fig.9-14: Sources of supply for radial fans and connection accessories

Elektror's radial fan names (preferred types) for tube ventilation

Motor frame size MAD...	Fan*	
	Air tube length 10 m	Air tube length 15 m
100	D064M	RD16
130	RD64	RD72
160	RD5	RD6
180	RD62	RD64
225	RD7	RD7

*) for 400 V/50 Hz

Fig.9-15: Preferred radial fan types

For more detailed information about the radial fans, e.g., technical data, dimension drawings or radial fans for different supply voltages, please contact Elektror.

Application Guidelines

9.8.3 Coolant

MAF motors may only be operated via an externally connected cooling system. The motor power loss P_V which has been converted into heat is dissipated via the coolant. For this reason, MAF motors may only be operated as long as coolant supply is ensured. The machine manufacturer has to design the cooling system such that all flow, pressure, cleanliness, temperature gradient and other requirements are met in any operating condition.

NOTICE**Impairment or failure of motor, machine or cooling system!**

- Observe the manufacturer's instructions when designing and operating cooling systems.
- Do not use coolants or cutting materials from machining processes.

Any information and technical data refer to water as coolant. If other coolants are used, this data is not applicable any longer and must be redetermined.

Cooling with running water from the public supply network is not allowed. Hard water may cause precipitations or corrosion and damage both motor and cooling system. Water which is to be used as cooling water must comply with certain criteria and treated accordingly if necessary. For detailed information, please contact your manufacturer of coolant additives.

To ensure corrosion protection and chemical stabilization, an additive which is suitable for mixed installations with materials according to [chapter 9.8.5 "Materials Used" on page 236](#) must be admixed to the cooling water.

If the coolants, additives or cooling lubricants used are too aggressive, the motors may be damaged to an irreparable degree.



⇒ Use systems with a closed circuit and fine filter $\leq 100 \mu\text{m}$.

⇒ When selecting the coolants, observe the environmental protection and disposal regulations applicable at the place of use.

Aqueous solution

Aqueous solutions ensure reliable corrosion protection without any appreciable changes in the physical properties of the water. The recommended additives do not contain any materials that are hazardous to water.

Emulsion with corrosion protection

Corrosion protection oils for cooling water circuits contain emulsifiers which ensure fine distribution of the oil in the water. The oily components of the emulsion protect the metal surfaces of the coolant duct against corrosion and cavitation. An oil content of 0.5 to 2 vol.% has proven its worth.

If, in addition to its function of corrosion protection, the corrosion protection oil also assumes the function of lubricating the coolant pump, the oil content must be approx. 5 vol.%.

- Observe the pump manufacturers' instructions.

Cleaning the coolant circuit

Check and clean (rinse) the cooling system at regular intervals as specified in the machine and/or cooling system manufacturer's maintenance schedule.

Note that the use of inappropriate cleaning agents may damage the motor cooling system to an irreparable degree. Bosch Rexroth is not responsible for damage of this type.

NOTICE Inappropriate cleaning agents may damage the motor cooling system and invalidate the warranty!

- ⇒ Only use fluids or materials for cleaning and cooling the motor, which do not attack the motor cooling system and do not react aggressively to the materials we use.
- ⇒ Observe the cleaning agents manufacturer's and the cooling system manufacturer's instructions.

9.8.4 Coolant Additives

Recommended manufacturers of coolant additives

The proper chemical treatment of the closed water systems is precondition to prevent corrosion, to maintain thermal transmission, and to minimize the growth of bacteria in all parts of the system.

Bosch Rexroth recommends using coolant additives of the company NALCO Deutschland GmbH.

Depending on the size of the cooling system, the user may use different additives in form of "ready-to-use cooling water" and "water treatment kits".



The packaging size and the ingredients of the water treatment kit are completely adapted to the corresponding system volume and the user may fill them into the coolant reservoir without observing further mixing ratios.

Ready-to-Use Cooling Water (Company NALCO)

System volume in liters	Order code	Additives NALCO...
0.5 ... 50	Nalco PCCL100.11R	PCCL100

Fig.9-16: Ready-to-Use Cooling Water (Company NALCO)

Cooling Water NALCO PCCL100

Nalco PCCL100 is a ready-to-use, preserved cooling water for the use in closed cooling water systems. It is supplied directly to the closed systems and contains all reagents in the proper treatment concentration.

Nalco PCCL100 contains a corrosion inhibitor protecting ferrous metal, copper, copper alloys and aluminum against corrosion. Nalco PCCL100 is free of nitrite and minimizes the micro-biological growth.

Water Treatment Kits (Company NALCO)

System volume in liters	Order code	Additives NALCO...
50 ... 100	480-BR100-100.88	TRAC100 7330 73199
100 ... 200	480-BR100-200.88	
200 ... 350	480-BR100-350.88	
350 ... 500	480-BR100-500.88	

Fig.9-17: Water Treatment Kits (Company NALCO)

Coolant additive NALCO TRAC100

Nalco TRAC100 is a liquid corrosion and film inhibitor for the use in closed cooling systems. Optionally with TRASAR technology: It monitors, shows and dosages the product automatically to its target concentration and continuously protects the system. NALCO TRAC100 is a complete inhibitor protecting ferrous metal, copper alloys and aluminum against corrosion. NALCO TRAC100 is free of nitrite and minimizes the requirements for micro-biological control.

Application Guidelines

Coolant additive NALCO 7330 Nalco 7330 is a non-oxidizing broad band biocide and suitable for application in closed cooling circuit systems.

Coolant additive NALCO 73199 Nalco 73199 is an organic corrosion inhibitor supporting a fast own protection layer and covering protection layer for non-ferrous metals.

The above additives are part of the preventive water treatment program by Nalco. It comprises not only the chemicals but also test methods, service and equipment. All these are made available to the user of the products.

The water treatment program is a specification for the user and describes the minimum requirements. Consult Nalco on any additional equipment, tests and services to ensure optimum performance and system protection of the cooling systems.

For additional information and order placement, please contact:

NALCO Deutschland GmbH

Planckstr. 26

71691 Freiberg/Neckar, Germany

Fax +49(0)7141-703-239

www.nalco.com



Bosch Rexroth is not in a position to give general statements or carry out investigations regarding applicability of process-related coolants, additives, or operating conditions.

The performance test for the used coolants and the design of the liquid coolant system are generally the responsibility of the machine manufacturer.

9.8.5 Materials Used

When used in MAF motors, the coolant comes into contact with the following materials:

Motor, housing	Screw connections	Quick coupling
CU, CuZn39Pb2	Chome-plated brass	Chome-plated brass

Fig.9-18: Materials in the cooling circuit

When designing and operating the cooling system, the machine manufacturer has to exclude chemical or electrochemical interactions with subsequent corrosion or decomposition of motor parts.

9.8.6 Coolant Supply Temperature

According to DIN EN 60034-1, IndraDyn A motors are designed for operation at a coolant temperature ranging from +10 to +40 °C. It is absolutely necessary that this temperature range is observed. If coolant temperatures are higher, the available torque will be considerably reduced. Due to high temperature gradients, lower coolant temperatures can cause destruction of the motors.



Install systems for monitoring the flow, pressure and temperature in the cooling circuit.

Setting the supply temperature

The coolant supply temperature must be adjusted such that the specified temperature range is kept and the present surrounding air temperature is taken into account.

The lower limit of the recommended coolant supply temperature can be restricted depending on the existing surrounding air temperature.



The coolant supply temperature must be adjusted within a range from +10 to +40 °C and may be below the existing room temperature by max. 5 °C only to prevent moisture condensation.

Example 1:

Surrounding air temperature: +20 °C

Coolant supply temperature to be set: +15 ... +40 °C

Example 2:

Surrounding air temperature: +30 °C

Coolant supply temperature to be set: +25 ... +40 °C

9.9 Motor Temperature Monitoring

In their standard configuration, IndraDyn A motors are equipped with integrated temperature sensors for motor protection.

Temperature measurement sensors

Description	KTY84-130
Resistance at 25 °C	577 ohms
Resistance at 100 °C	1000 ohms
Continuous current at 100 °C	2 mA

Fig. 9-19: Temperature measurement sensor

The response temperatures of the sensors are as follows:

⇒ 110 °C prewarning temperature

⇒ 120 °C Shut-off temperature

Exception:

- Frame size MAD225 ⇒ 120 °C prewarning temperature
- Frame size MAD225 ⇒ 130 °C shut-off temperature

Application Guidelines

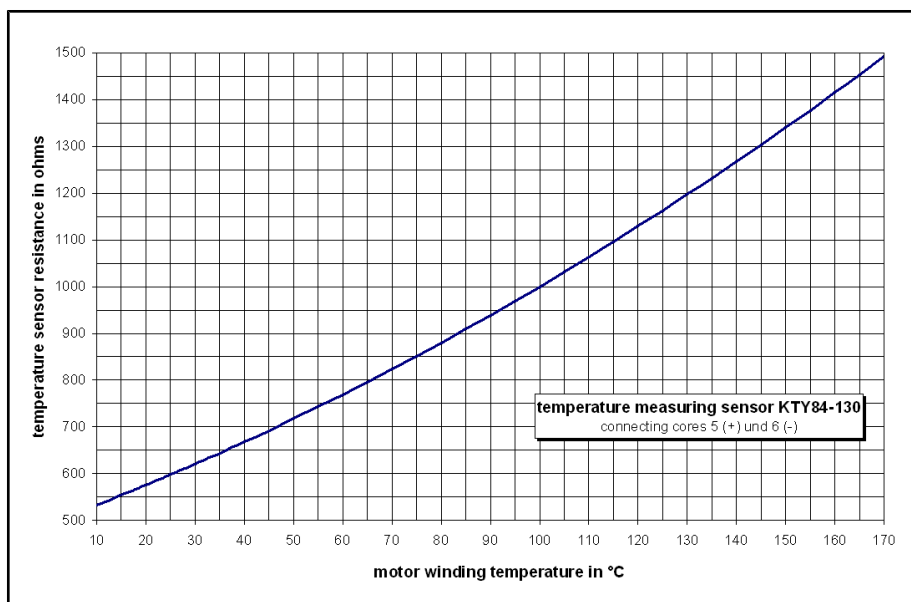

Fig.9-20: Characteristic curve of temperature measurement sensor KTY84-130 (PTC)

For more information on the connection of temperature sensors, please refer to [chapter 8.7 "Temperature Sensor"](#) on page 218.

9.10 Holding Brake (Optional)

9.10.1 General Information

The holding brake serves to hold axes which have come to a standstill. It may only be used while the motor is at standstill or to carry out the brake test integrated in the drive.



Do not use the holding brake as an operating brake for moving axes. If the holding brake is repeatedly activated with the drive rotating or the allowed braking energy is exceeded, premature wear and tear may occur. It must be expected that the holding brake is completely worn after approx. 20,000 revolutions against the applied brake.

Brake activation

The voltage supply of the holding brake is to be designed such that the voltage available at the motor (**24 volts +/- 5%**) for releasing/applying the holding brake is sufficient even in the most unfavorable case during installation and operation (see also Rexroth IndraDrive Drive Systems with HMV01/02, HMS01/02, HMD01, HCS02/03, Chapter "Project Planning of Control Voltage").



The switching voltage incoming at the motor is subject to the line length and the cable properties, e.g., conductor resistance.

- A minimum voltage of 22.8 V (24 V - 5 %) is recommended at the drive controller for ready-made Bosch Rexroth power cables up to 50 m in length.
- A minimum voltage of 24.7 V (26 V - 5 %) is recommended at the drive controller for ready-made Bosch Rexroth power cables more than 50 m in length.

In order to detect a fault during operation early enough, a monitoring device must be provided to monitor the voltage supply for the brakes for undervoltage.

Functional test Prior to commissioning and on request during operation, the brake must be tested for proper functioning via the brake test using the brake monitoring command. A low torque is applied to the motor to check whether the brake has been completely released. For additional information and data on the availability, please refer to the firmware functional descriptions of Rexroth controllers.

Observe the commissioning-related guidelines for holding brakes in chapter [chapter 12 "Operating of IndraDyn A Motors" on page 281](#).

9.10.2 Holding Brakes - Notes Regarding Safety

Observe the safety requirements for the system planning and development.

DANGER

Personal injury through hazardous movements caused by falling or descending axes!

Secure vertical axes against falling or descending after disconnection:

- lock the vertical axes mechanically,
- provide an external braking / collecting / clamping device, or
- ensure sufficient equilibration of the vertical axes.

The serially delivered holding brakes which are driven by the control device are **not** suited for personal safety!

Personal protection must be realized by superordinate fail-safe measures, such as e.g. the locking off of the danger zone by means of a protective fence or grill.



Observe supplementary standards and recommendations.

For European countries:

- **EN 954 and ISO 13849-1 (2007) and ISO 13849-2 (2003) Safety-related components of controls**
- **Information sheet no. 005 "Gravity-loaded axes (vertical axes)" Edition 02/04 (published by: Fachausschuss Maschinenbau, Fertigungssysteme, Stahlbau)**

For the USA:

- See National Electric Code (NEC), National Electrical Manufacturers Association (NEMA) as well as local building regulations.

The following is generally valid: Comply with all applicable national regulations!

The permanent magnetic brake is no safety brake. This means, a torque reduction by non-influenceable disturbance factors can occur (see EN 954 and ISO 13849-1 (2007) and ISO 13849-2 (2003) or the information leaflet No. 005 about "Gravity-loaded axes (vertical axes)").

Please pay particular attention to the following:

- Corrosion on friction surfaces, as well as dust, perspiration and sediments reduce the braking effect.
- Grease must not hit the friction surface.
- Overvoltage and too high a temperature can weaken the permanent magnets and thus the brake.

Application Guidelines

Engaging of the brake is no longer ensured, if the air gap between armature and pole is improperly increased due to deterioration. In this case, no braking occurs.

9.10.3 Selecting Holding Brakes

General Information

Brakes are either electrically clamping or electrically releasing. Since there are functional differences between main spindle and servo axes, different brakes should be used for these axes.

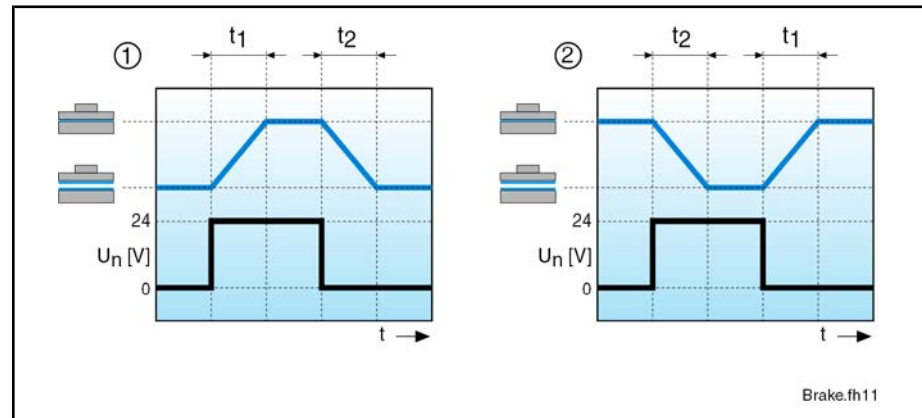

- ① Electrically clamping brake
 ② Electrically releasing brake
 t_1 Holding brake connection time, clamping delay
 t_2 Holding brake disconnection time, release delay

Fig. 9-21: Holding brake wiring diagram

Main Spindle Applications

Electrically clamping holding brake

The **electrically clamping** holding brake serves as a locking element for the main spindle at standstill and deactivated controller enable, e.g., when the tool is changed without closed position loop.



Clamp the holding brake only while the motor is at standstill, i.e., after the drive has signaled that the motor has come to a standstill.

The **electrically releasing** holding brake should not be used for main spindle applications because the brake may not only be under extreme wear and tear but may also be destroyed if the holding brake is applied unintentionally at high speeds (e.g., voltage failure or wire break).

Servo Applications

Electrically releasing holding brake

The **electrically releasing** holding brake serves to hold axes at standstill and with deactivated controller enable. If the supply voltage fails and the controller enable is deactivated, the **electrically releasing** holding brake is applied automatically.

- Do not use the holding brake as an operating brake for moving axes.

If the brake is repeatedly activated with the drive rotating or the allowed braking energy is exceeded, premature wear and tear may occur.

The **electrically clamping** holding brake is inappropriate for servo applications because there will be no clamping of axes in the de-energized state.

9.10.4 Layout of Holding Brakes

Holding brakes on motors of Rexroth are basically not designed for service braking. The effective braking torques are different in static and dynamic operation for physical reasons.

Normal operation and EMERGENCY STOP	Fault condition
In normal operation , using the holding brake for clamping of a standstill axis, the "static holding torque" (M_4) - adhesive friction applies. In case of EMERGENCY STOP for the deactivation of an axis ($n < 10 \text{ min}^{-1}$), a "dynamic holding torque" (M_{dyn}) – sliding friction is effective.	Under a fault condition , using the holding brake for the deactivation of a moving axis ($n \geq 10 \text{ min}^{-1}$), a "dynamic holding torque" (M_{dyn}) – sliding friction is effective.
$M_4 > M_{\text{dyn}}$ Therefore, note the following description of dynamic sizing.	

Fig.9-22: Dynamic sizing

Dynamic sizing

The load torque must be smaller than the minimum dynamic torque M_{dyn} which the holding brake can provide. Otherwise the dynamic holding brake torque is not sufficient to stop the axes.

If a mass is to be decelerated in a defined time or in a defined route, the additional mass moment of inertia of the whole system must be taken into account.

Project planning recommendation

To ensure the system's safety, reduce the required holding torque to 60% of the static holding torque (M_4) of the holding brake.

Application Guidelines

9.11 Motor Encoder

9.11.1 Options

"S2": Single-turn absolute encoder with EnDat2.1 interface. Sine/cosine signals 1 V_{ss} with 2048 periods per revolution and absolute period assignment within one revolution. The encoder features a data memory which contains all relevant motor parameters required for commissioning the motor.

"M2": Multi-turn absolute encoder with EnDat2.1 interface. Sine/cosine signals 1V_{ss} with 2048 periods per revolution and absolute period assignment within 4096 revolutions. The axis position remains stored in the event of a voltage failure. The encoder features a data memory which contains all relevant motor parameters required for commissioning the motor.

"S6": Optional encoder for potentially explosive atmospheres in pressure-resistant encapsulation with 15 m long connecting cable. Technical properties same as for "S2".

"M6": Optional encoder for potentially explosive atmospheres in pressure-resistant encapsulation with 15 m long connecting cable. Technical properties same as for "M2".

"C0": Incremental encoder. Sine/cosine signals 1 V_{ss} with 2048 periods per revolution.

"N0": The motor is delivered without any factory-mounted encoder unit. The motor is closed with a cover on its rear.



For more information on the supply voltage required for the motor encoders, please refer to [fig. 6-2 "IndraDyn A motor encoders" on page 179](#).

9.11.2 Compatibility

Due to their varying technology, the motor encoders can only be connected to specific controllers and interfaces. The encoder data must be parameterized in the controller. The following table gives an overview of the compatibility:

Encoder option	IndraDrive					
	ADVANCED	BASIC OPENLOOP	BASIC SERCOS	BASIC PROFIBUS	BASIC ANALOG	BASIC UNIVERSAL
C0	+	-	-	-	-	+
M2, M6 S2, S6	+	+	+	+	+	+
+ ⇒ compatible - ⇒ not compatible						

Fig.9-23: Encoder compatibility

9.11.3 Accuracy

The accuracy of rotary encoders is divided into "absolute accuracy" and "relative accuracy".

Absolute

The absolute accuracy of rotary encoders is primarily determined by the quality and precision of the encoder construction and the mechanical attachment to the motor. The following values are applicable for IndraDyn A motors:

Encoder option	Technical data	Absolute accuracy
S2, S6	Single-turn absolute encoder with EnDat2.1 interface. Sine/cosine signals 1 Vss with 2048 periods.	$\pm 0.0056^\circ$ ($\pm 20''$)
M2, M6	Multi-turn absolute encoder with EnDat2.1 interface. Sine/cosine signals 1 Vss with 2048 periods.	$\pm 0.0056^\circ$ ($\pm 20''$)
C0	Incremental encoder, sine/cosine signals 1 Vss with 2048 periods.	$\pm 0.0056^\circ$ ($\pm 20''$)

Fig.9-24: Absolute encoder accuracy

Relative

The relative accuracy of encoder systems is also referred to as "repeat accuracy". It is mainly determined by the interpolation discrepancies occurring when the measurement signals are further processed in the built-in and the external interpolation and digitization electronics. The following reference values are applicable for IndraDyn A motors which are operated with Rexroth controllers (as of the publishing date of this documentation):

Encoder option	Technical data	Relative accuracy
S2, S6	Single-turn absolute encoder with EnDat2.1 interface. Sine/cosine signals 1 Vss with 2048 periods.	$\pm 0.001'$
M2, M6	Multi-turn absolute encoder with EnDat2.1 interface. Sine/cosine signals 1 Vss with 2048 periods.	$\pm 0.005'$
C0	Incremental encoder Sine/cosine signals 1 Vss with 2048 periods.	$\pm 0.01'$

Fig.9-25: Relative encoder accuracy

Since both hardware and firmware of the controllers are under continuous further development, actual values may be different from the values specified above. Therefore, the data in the current documentation of the controllers must always be observed.

The accuracy of encoder systems is only a subordinate factor for the precision of machining and positioning process of a plant. Factors that are decisive for the accuracy that can be reached are, among others, the functionality of the plant and the quality of the mechanical construction.

9.11.4 Encoder Connection

The position of the encoder connection cannot be changed. For more detailed information, please refer to the motor dimension drawing and to [chapter 8.6 "Encoder Connection"](#) on page 216.

For detailed information on the controller-sided encoder connection and parameterization, please refer to the documentation of the controllers.

Application Guidelines

9.12 Output Shaft

9.12.1 Plain Shaft

The recommended standard configuration of all IndraDyn A motors features a non-positive, non-floating shaft-hub connection with a high degree of smooth running. Use clamping sets, pressure sleeves or clamping elements for coupling the machine elements to be driven.

9.12.2 Output Shaft with Keyway

The optional keyway according to DIN 6885, Sheet 1, Edition 08-1968, allows form-locking transmission of torques with constant direction and low requirements for the shaft-hub connection.

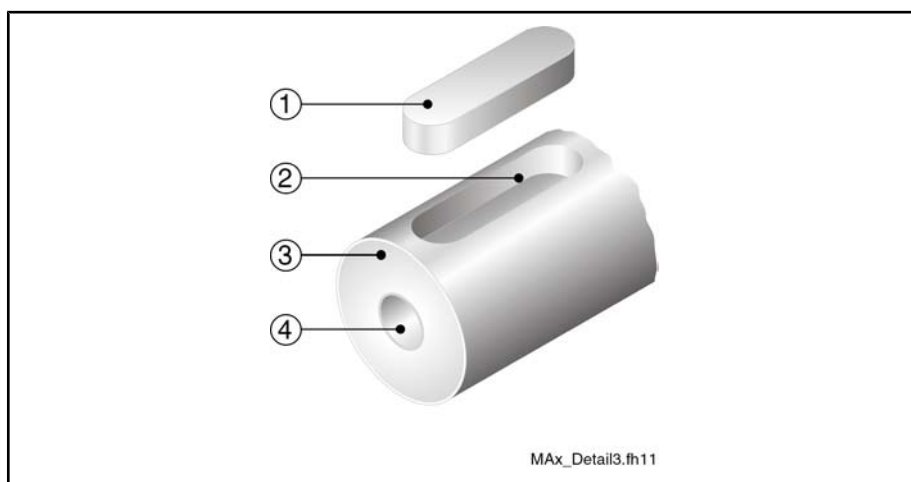

- ① Keyway
- ② Keyway groove
- ③ Motor shaft
- ④ Centering hole

Fig.9-26: Output shaft with keyway

In addition, the machine elements to be driven must be secured in axial direction via the centering hole on the end face.



- ⇒ Avoid strong reversing operation.
- ⇒ Deformations in the vicinity of the keyway groove may result in a breakage of the shaft.
- ⇒ The keyway is included in the motor scope of delivery.

Balancing with half keyway

The motor is balanced with a half keyway. Mass ratios are comparable to those of a plain shaft. If a complete keyway is inserted, there will be an imbalance which must be compensated at the machine element to be driven.

The hub of a machine element to be driven (pinion, pulley, etc.) should correspond to the length of the keyway.



- Use a graduated keyway in case of a short hub.

Balancing with complete keyway

The motor is balanced with the supplied keyway. That means that the machine element to be driven must be balanced without keyway. The groove length in the hub is independent of the length of the keyway.

Modifications to the keyways can only be made by the user himself and within his own responsibility. Bosch Rexroth does not give any warranty for modified keyways or motor shafts.

9.12.3 Output Shaft with Shaft Sealing Ring

If equipped with the optional radial shaft sealing ring according to DIN 3760 - design A, IndraDyn A motors are, e.g., suitable for attachment in a dusty environment and in moist rooms or for attachment of gears with closed oil bath or oil circulation lubrication.



If the motor is used in strong atomized spray or at speeds over 4000 min⁻¹, we recommend that you order the motor with additional labyrinth seal (see [chapter 9.12.4 "Output Shaft with Labyrinth Seal" on page 246](#)).

Fluids (e.g., cooling lubricants, gear oil, etc.) may not be present at the output shaft. If, e.g., gears are attached, only gears with a closed (oil-tight) lubrication system may be used.

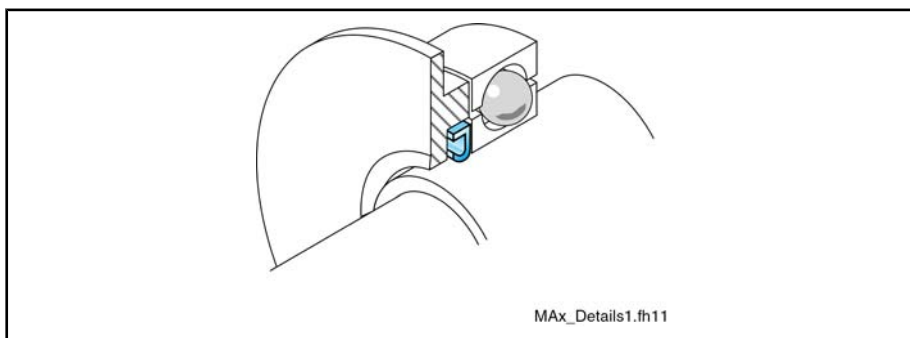

Fig.9-27: Shaft sealing ring

Wear Radial shaft sealing rings are rubbing seals. They are therefore subject to wear and generate frictional heat. Wear symptoms of the rubbing seal can be reduced if the sealing point is adequately clean. The service life of the sealing lip at the radial shaft sealing ring depends on the cleanliness and the motor speed.

Resistance The materials used for radial shaft sealing rings are highly resistant against oils and chemicals. However, the machine manufacturer is responsible to check whether the rings are suitable for the particular conditions of use.

The following material assignment has been applicable as of the publishing date of this document:

Motor MAD/MAF ...	Sealing material	Short name
100 ... 225	Polytetrafluoroethylene	PTFE

Fig.9-28: IndraDyn A shaft sealing ring

The complex interactions between sealing ring, shaft and fluid to be sealed on the one hand and the particular conditions of use (frictional heat, soiling, etc.) on the other hand do not allow any accurate calculation of the service life of the shaft sealing ring.

However, with a circumferential speed of 5 m/s and under favorable conditions (e.g., adequate cleanliness), a useful life of 5,000 ... 10,000 h can be reached.

Vertical installation positions IM
 V3 / IM V6

Motors with shaft sealing ring have IP 65 degree of protection on their flange side. Therefore, tightness is ensured only against incoming splash fluids. Here, it must be noted that continuously incoming splash fluids accumulate between

Application Guidelines

motor shaft and shaft sealing ring due to the adhesive forces at the sealing point, so that they act as present fluids. Continuously incoming splash fluids require a higher degree of protection than, e.g., a labyrinth seal.

If the motor is installed in a vertical position, please additionally observe the guidelines in [chapter 9.6.3 "Vertical Installation Positions"](#) on page 229.

9.12.4 Output Shaft with Labyrinth Seal

To be protected against incoming splash fluids at the motor output shaft, IndraDyn A motors can also be directly ordered with a labyrinth seal. Please also observe the correct order designation of the motors in the motor type code in this context.

Proper functioning of the labyrinth seal is only ensured when

- the motor is installed horizontally,
- the drain hole is positioned below the output shaft,
- the fluid level present at the motor is at least 5 mm below the drain hole,
- the motor speed is at least 200 min⁻¹.

On delivery of the motor, the labyrinth seal is mounted such that, as seen from side A of the motors, the terminal box and the power plug are positioned at the top and the drain hole of the labyrinth seal is positioned at the bottom (below the output shaft).



There are certain installation situations where the motor must be installed with the power connection being positioned laterally or facing down. In these cases, the flange of the labyrinth seal must be turned before installation of the motor such that the drain hole is again positioned below the output shaft.

Modifying the position of the drain hole of the labyrinth seal

If the motor is not mounted as delivered (power connection at the top), the position of the drain hole of the labyrinth seal must be adjusted.

To achieve this, the flange of the labyrinth seal can be rotated in 30° increments. In this manner, the drain hole can be quickly adjusted to the conditions of the machine, i.e., aligned downwards.

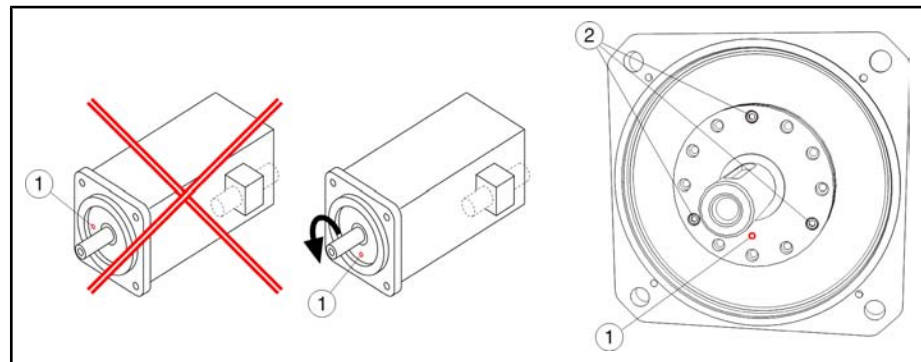

① Drain hole (always align the drain hole downwards in relation to the motor installation position)

② Mounting screws M6 DIN912 (4 pcs. for MAx225)

Fig.9-29: Allowed position of the drain hole of the labyrinth seal (example MAD130)

To put the drain hole into the correct position, the following working steps must be carried out before the motor is mounted:

1. Unscrew the mounting screws ①.

⇒ To facilitate unscrewing the screws, heat them up to approx. 70 °C because they are locked with Loctite 243 screwlock.

2. Observe the required installation position of the motor and turn the flange into the position in which the drain hole ② is again positioned below the output shaft.
3. Apply Loctite 243 to the mounting screws and screw them into the corresponding threaded holes through the holes in the flange.
⇒ Observe the 30° increments!
⇒ Tightening torque of the mounting screws: 9 Nm

9.13 Bearing Variants and Shaft Load

9.13.1 Bearing Variants

The following bearing variants are available depending on the frame size of the IndraDyn A motors:

- Standard bearing "N" = deep-groove ball bearing
- A-side fixed bearing "A" = deep-groove ball bearing
- High-speed bearing "H" = deep-groove ball bearing, light construction
- Reinforced bearing "V" = deep-groove ball bearing + cylindrical roller bearing

Standard bearing	<p>Universal bearing type (type code option "N") suitable for absorbing low to medium radial and axial forces.</p> <p>Advantages:</p> <ul style="list-style-type: none">• High availability and long service life.• Suitable for high speeds.• Low-noise running. <p>Limitation:</p> <ul style="list-style-type: none">• Only suitable for low to medium radial and axial loads.
A-side fixed bearing	<p>Universal bearing type (type code option "A") suitable for absorbing high circumferential radial forces.</p> <p>Advantages:</p> <ul style="list-style-type: none">• Increased availability and longer service life under the effect of circumferential radial forces.• Allows absorption of increased circumferential radial forces, such as they can occur when the motor is operated in connection with a coupling.• Low-noise running.• Thermally induced shaft expansion does not affect the machine accuracy. <p>Limitation:</p> <ul style="list-style-type: none">• Motors with A-bearing are not available with brake.
High-speed bearing	<p>The high-speed bearing (type code option "H") features a deep-groove ball bearing of appropriately light construction and therefore allows very high speeds.</p> <p>Advantage:</p> <ul style="list-style-type: none">• Very high speeds are possible. <p>Limitation:</p>

Application Guidelines

- Can only be used with low radial load.
- Can only be used when the motor is installed horizontally.
- Cannot be used in combination with a shaft sealing ring.

Reinforced bearing

The reinforced bearing (**type code option "V"**) features an additional cylindrical roller bearing on the output side.

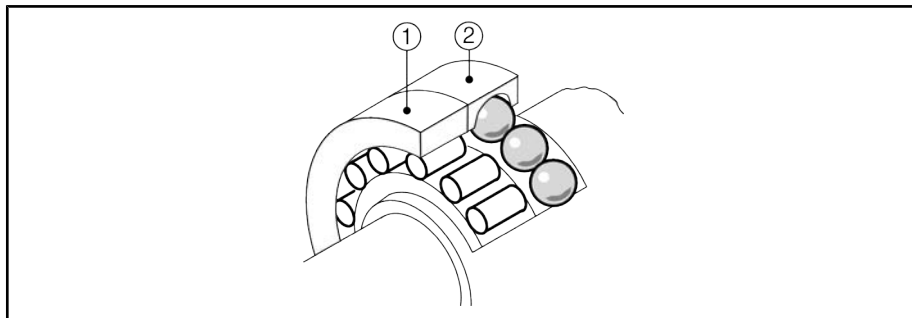

- ① Cylindrical roller bearing
② Deep-groove ball bearing

Fig. 9-30: Reinforced bearing

Advantage:

- Can absorb increased radial forces.

Limitation:

- The grease service life of the reinforced bearing is reduced to half the default value.
- In some motors, the allowed maximum speed is reduced.
- Motors with reinforced bearing may only be operated with a continuous radial load. Developing kinetic friction might damage the bearings.

Motors with reinforced bearing must at least be operated with the following radial loads:

Frame size	130	160	180	225
Minimum radial load [kN]	1	1.5	2	

Fig. 9-31: Minimum radial load with reinforced bearing

9.13.2 Selection Tips

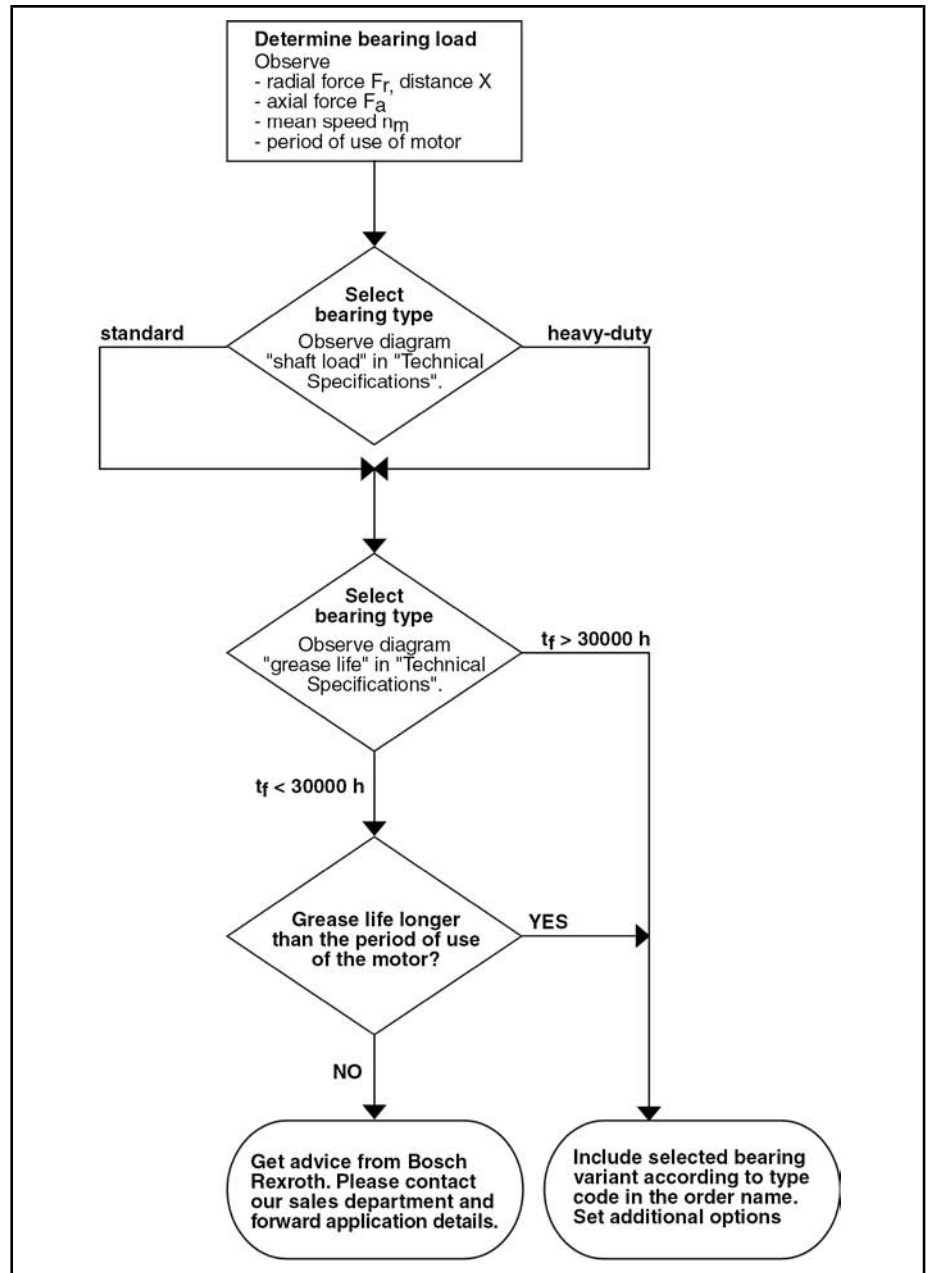

Fig.9-32: Bearing selection flow diagram

9.13.3 Radial Load, Axial Load

During operation, both radial and axial act on the motor shaft and therefore on the bearings as well. The machine construction and the motor type must be carefully coordinated to ensure that the specified load limits will not be exceeded.

Application Guidelines

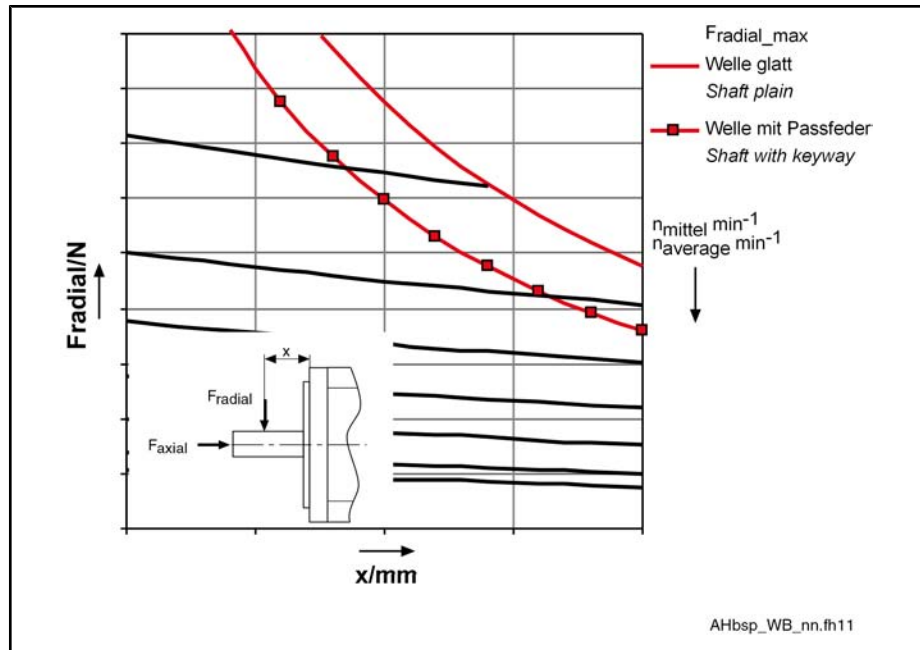

Fig.9-33: Example shaft load diagram

Maximum allowed radial force

The maximum allowed radial force F_{radial_max} depends on the following factors:

- Force action point x
- Shaft version (plain or with keyway groove)

Allowed radial force

The allowed radial force F_{radial} depends on the following factors:

- Arithmetically averaged speed (n_{mean})
- Force action point x
- Bearing service life

Allowed axial force

Only low axial shaft loads are allowed for IndraDyn A motors.

MAD/MAF...	100	130 ... 180	225
Allowed axial load F_{axial} [N]	30	50	100

Fig.9-34: Axial load

The allowed axial load is applicable to all installation positions. For this reason, IndraDyn A motors are **not** suitable for machine elements which generate axial motor loads (e.g., helical driving pinions).

When installing the motor vertically, also observe the guidelines in [chapter 9.6.3 "Vertical Installation Positions"](#) on page 229.



Avoid unallowed axial loads or impacts onto the motor shaft.

Mean speed

Acceleration and deceleration times can be omitted from calculation if the time during which the drive is operated at constant speed is considerably higher than the acceleration or deceleration times. If the mean speed is calculated according to the following equation, the acceleration and deceleration times are taken into account.

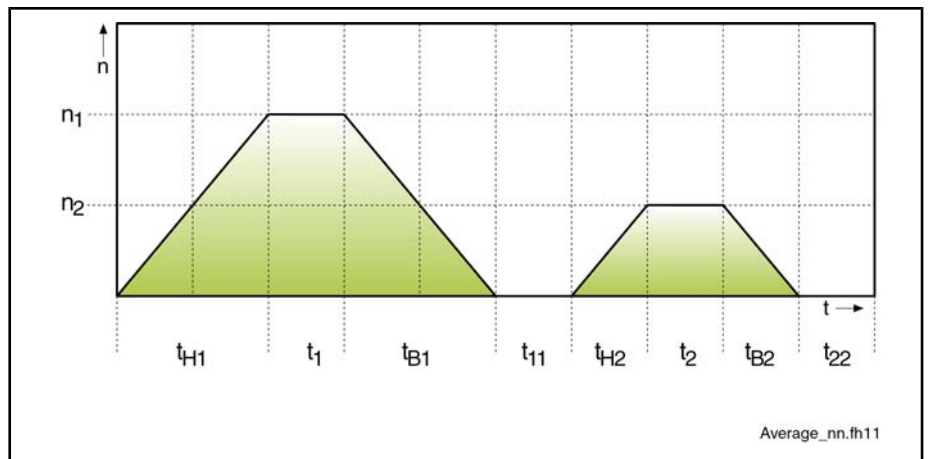

Fig.9-35: Mean speed (graphical diagram)

$$n_{1m} = \frac{\frac{n_1}{2} \cdot t_{H1} + n_1 \cdot t_1 + \frac{n_1}{2} \cdot t_{B1}}{t_{H1} + t_1 + t_{B1} + t_{11}}$$

- n_{1m} Mean speed in section 1
- n_1 Machining speed
- t_{H1} Acceleration time
- t_1 Machining time
- t_{B1} Deceleration time
- t_{11} Standstill time
- n_{2m} Mean speed in section 2
- n_2 Machining speed
- t_{H2} Acceleration time
- t_2 Machining time
- t_{B2} Deceleration time
- t_{22} Standstill time

Fig.9-36: Mean speed (calculation formula)

A complete machining cycle can consist of several sections with different speeds. In this case, the average must be calculated from all sections.

Application Guidelines

Shaft load with frame size 100

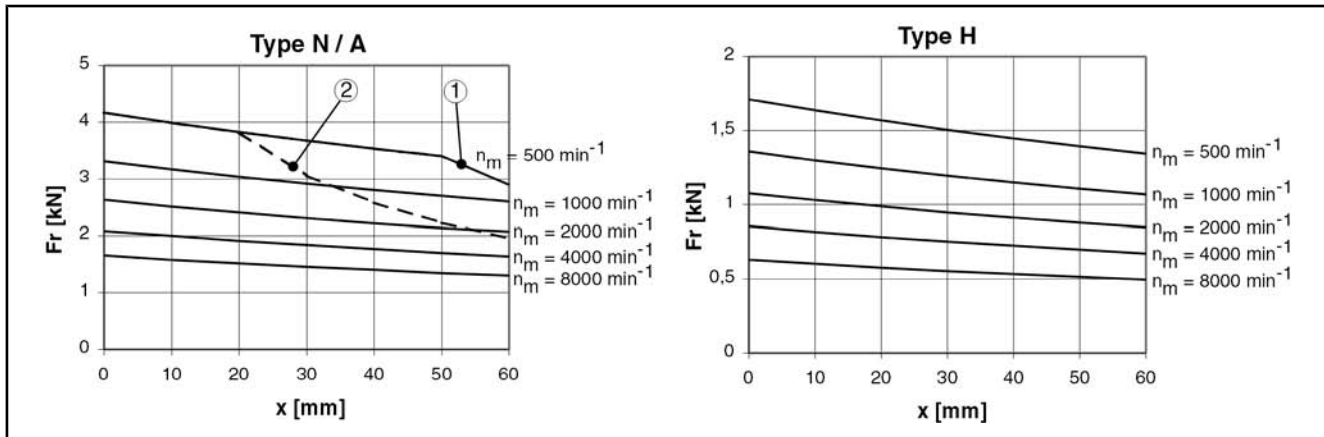

- N Standard bearing
- A A-side fixed bearing
- H High-speed bearing
- ① Load limit for output shaft without keyway
- ② Load limit for output shaft with keyway
- n_m Mean speed

Fig.9-37: Shaft load with frame size 100 ($L_h = 30,000$ operating hours)

Shaft load with frame size 130

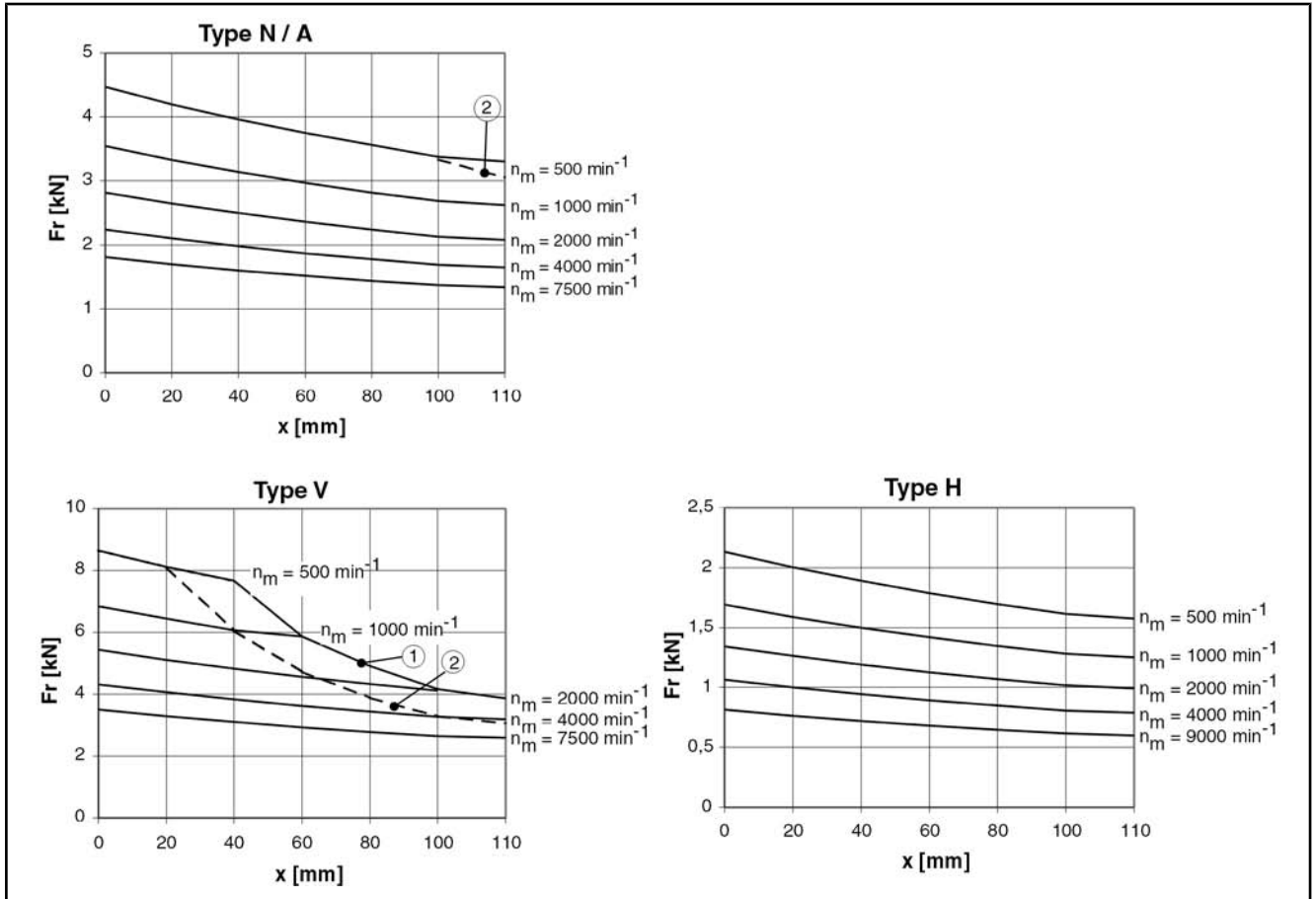

- N Standard bearing
- A A-side fixed bearing
- V Reinforced bearing
- H High-speed bearing
- ① Load limit for output shaft without keyway
- ② Load limit for output shaft with keyway
- n_m Mean speed

Fig.9-38: Shaft load with frame size 130 ($L_h = 30,000$ operating hours)

Application Guidelines

Shaft load with frame size 160

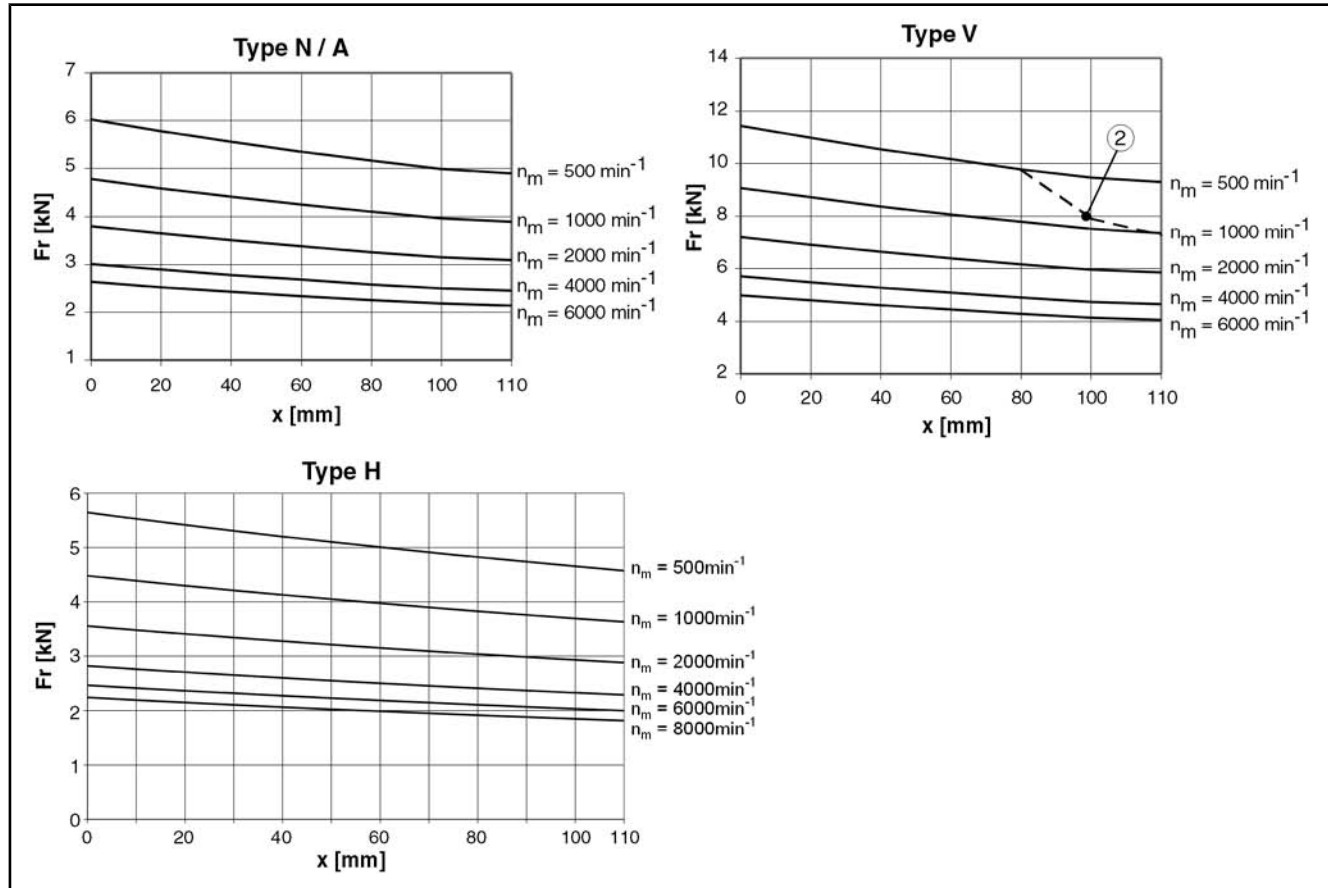

- N Standard bearing
- A A-side fixed bearing
- V Reinforced bearing
- H High-speed bearing
- ① Load limit for output shaft without keyway
- ② Load limit for output shaft with keyway
- n_m Mean speed

Fig.9-39: Shaft load with frame size 160 ($L_h = 30,000$ operating hours)

Shaft load with frame size 180

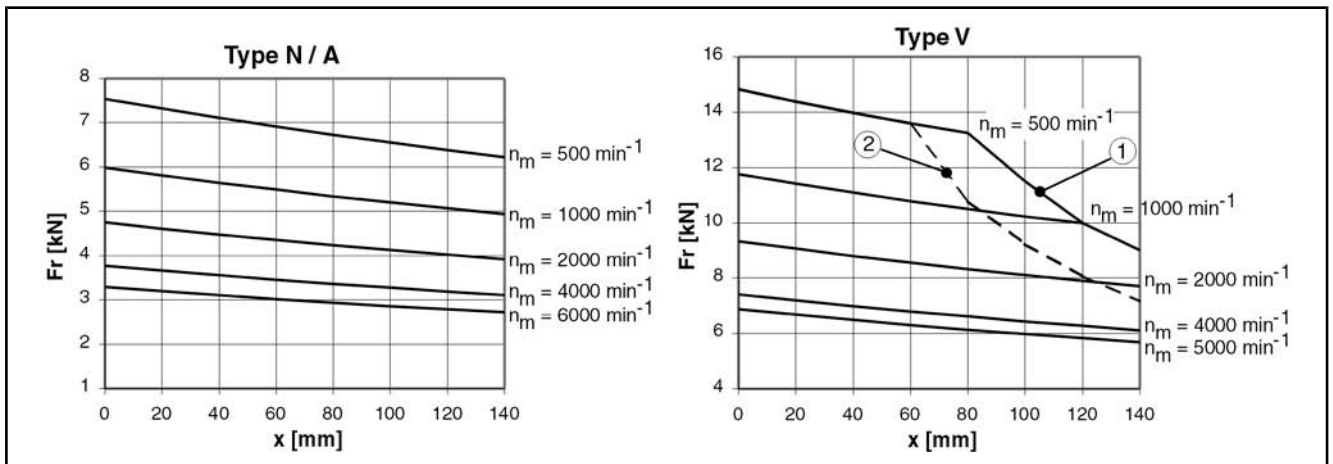

- N Standard bearing
- A A-side fixed bearing
- V Reinforced bearing
- ① Load limit for output shaft without keyway
- ② Load limit for output shaft with keyway
- n_m Mean speed

Fig. 9-40: Shaft load with frame size 180 ($L_h = 30,000$ operating hours)

Application Guidelines

Shaft load with frame size 225

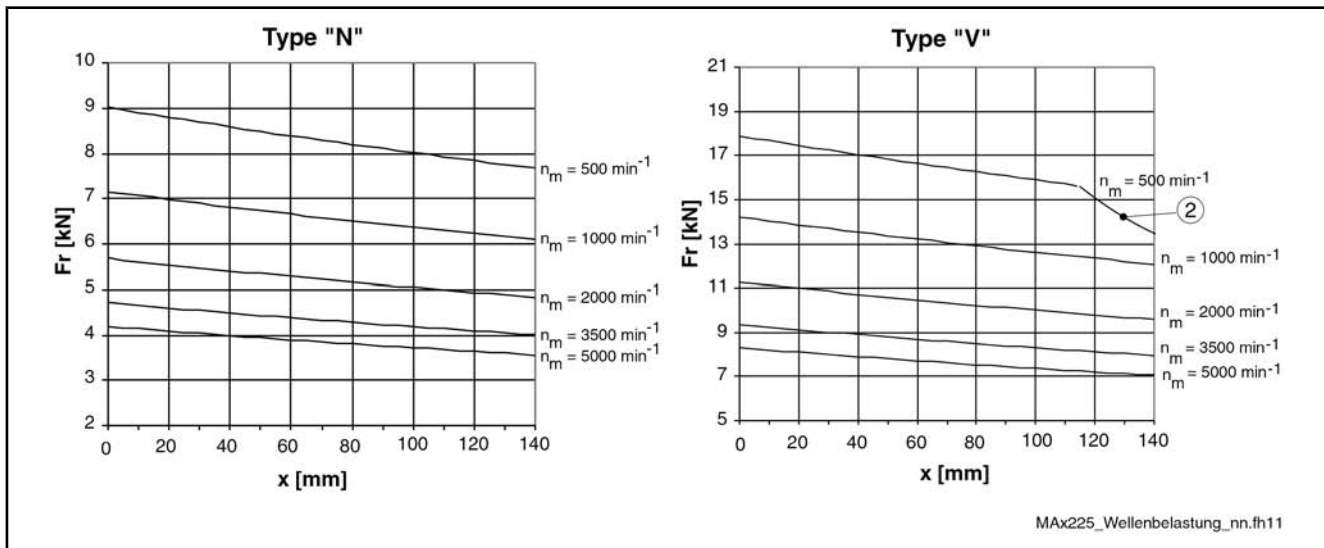

- N Standard bearing
- V Reinforced bearing
- ② Load limit for output shaft with keyway
- n_m Mean speed

Fig.9-41: Shaft load with frame size 225 ($L_h = 30,000$ operating hours)

9.14 Attaching Drive Elements

9.14.1 General Information

Whenever attaching drive elements to the output shaft, such as

- gearboxes
- couplings
- pulley
- pinions

it is absolutely necessary that the following guidelines be followed.

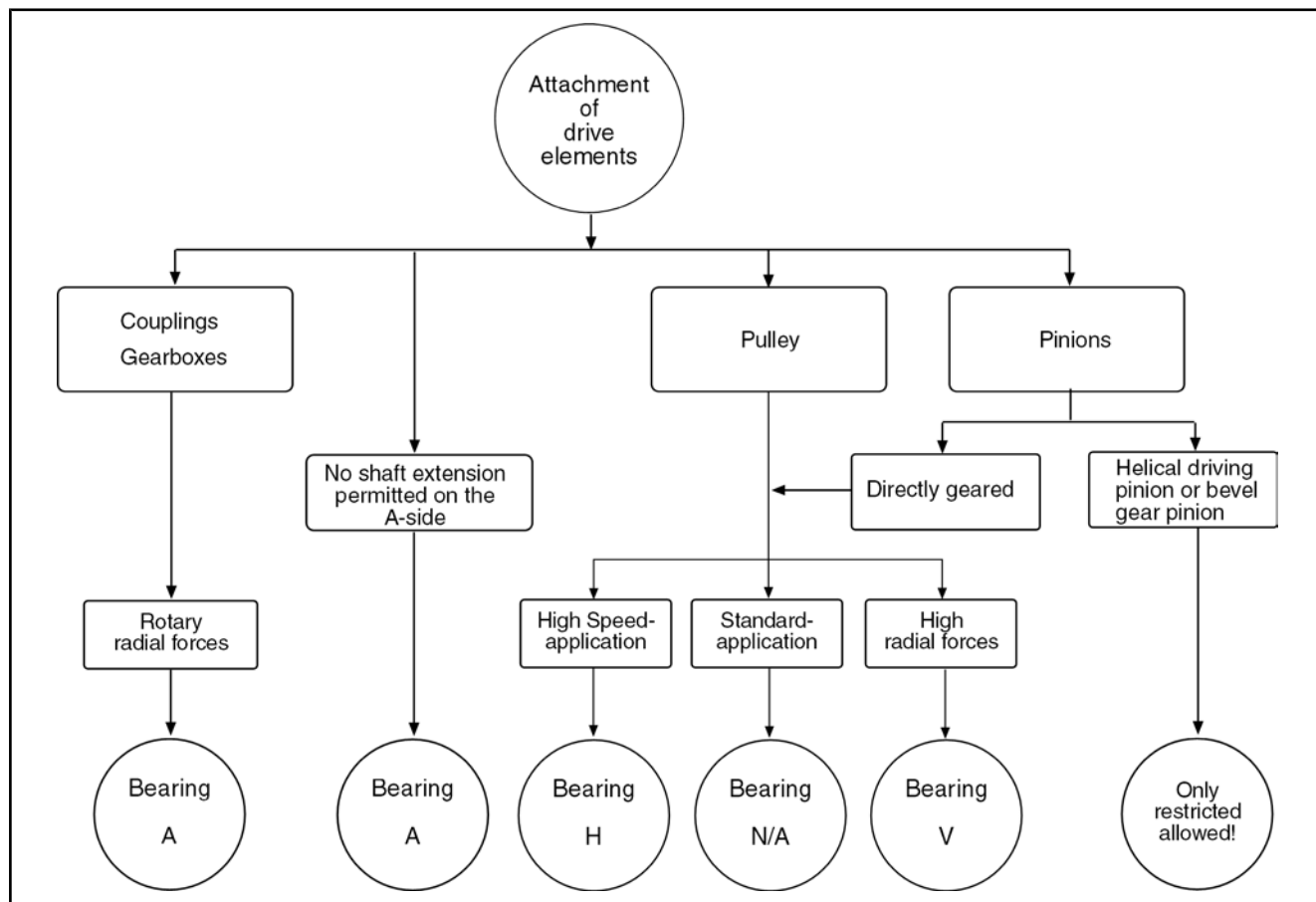

Fig.9-42: Attaching drive elements

Overdefined bearing

In general, it is absolutely necessary that overdefined bearings when attaching drive elements. The tolerances inevitably present in such cases will lead to additional forces acting on the bearing of the motor shaft and, where applicable, to a considerably reduced service life of the bearing and/or to fatigue transverse rupture/vibration rupture of the motor shaft.



If overdefined attachment cannot be avoided, it is absolutely necessary that Bosch Rexroth be consulted.

Application Guidelines

9.14.2 Gearboxes

NOTICE**Ingressing fluid may damage the motor!**

Fluids (e.g., cooling lubricants, gear oil, etc.) may not be present at the output shaft. When gearboxes are attached, only gearboxes with a closed (oil-tight) lubrication system may be used.

9.14.3 Couplings

Couplings are attached to transmit torques of two separate shaft ends. Usually, shaft offset, phase-angle errors or axial distances must be compensated. If the couplings attached are too stiff, a circumferential radial load (= constantly changing the angular position) can therefore be generated on the output side. This circumferential radial load may result in an unallowed high load of the bearing seat and therefore to a significantly reduced service life of the bearing.



Rexroth offers bearing variant "A" for attaching couplings to IndraDyn A motors.

By selecting bearing "A", increased circumferential radial forces can be absorbed without limiting the speed of the motor. In addition, there is no significant thermally induced change in length in the vicinity of the connection of the motor output shaft.

Motor frame size MAD/MAF...	Allowed circumferential radial forces $F_{\text{radial_max}}$ in N	
	Bearing A	Bearing N / H / V
100B	1000	25
100C	1000	25
100D	1000	30
130B	1200	40
130C	1200	50
130D	1200	55
160B	1500	65
160C	1500	65
180C	1800	95
180D	1800	100
225C	Not available	120

Fig.9-43: Allowed circumferential radial forces

Recommended couplings

In connection with bearing A, Rexroth recommends axially compensating couplings, such as

- spring disk couplings with two sets of springs (double gimbal),
- metal bellows couplings.

These coupling variants are free from play and have a high torsional strength with low radial spring stiffness.



If the recommended coupling types cannot be used, it is absolutely necessary that consult Bosch Rexroth be consulted.

For example, recommended manufacturers of the aforementioned couplings are:

- **A. Friedrich Flender GmbH**
Alfred-Flender-Strasse 77
46395 Bocholt, Germany
Phone +49 (0)2871 920
Fax +49 (0)2871 922 596
Internet: www.flender.com
- **JAKOB GmbH&CoKG**
Daimler Ring 42
63839 Kleinwallstadt, Germany
Phone +49 (0)6022 2208 0
Fax +49 (0)6022 2208 22
Internet: www.jakobantriebstechnik.de
- **R+W Antriebselemente GmbH**
Alexander-Wiegand-Strasse 8
63911 Klingenberg, Germany
Phone +49 (0)9372 9864 0
Fax +49 (0)9372 9864 20
Internet: www.rw-kupplungen.de

9.14.4 Skew Bevel Driving Pinions

By attaching skew bevel driving pinions directly to the drive shaft, the motor bearings are exposed to unallowed operation conditions in the vicinity of the force reversal point (reversal point between acceleration and deceleration or vice versa). What is more, the flange-side end of the output shaft may be displaced in relation to the motor housing due to thermal effects, thus exceeding the allowed axial forces of the motor bearings.



It is not allowed to **directly attach** skew bevel driving pinions to the drive shaft of the motor. If skew bevel driving pinions must be used nevertheless, no other drive elements may be used than self-bearing drive elements which are connected to the motor shaft via axially compensating couplings.

9.14.5 Bevel Gear Pinions

Depending on the motor bearings selected, the flange-side end of the output shaft may be displaced in relation to the motor housing due to thermal effects, thus exceeding the allowed axial forces of the motor bearings.

When bevel gear pinions directly attached to the output shaft are used, this change in length results in a thermally induced axial force if the drive pinions are located axially on the machine side. There is the risk of exceeding the maximum allowed axial force or of increasing the play within the gears to an unallowed high degree.

Application Guidelines



For this reason, bevel gear pinions may only be directly attached to the motor shaft if the motor is equipped with an A bearing. If bevel gear pinions must nevertheless be used in connection with a different bearing variant, no other drive elements may be used than self-bearing drive elements which are connected to the motor shaft via axially compensating couplings.

9.15 Bearing Service Life

The bearing service life is an important criterion for the availability of IndraDyn A motors. The bearing service life is divided into the "mechanical service life" of bearing components and material on the one hand and "grease service life" of the bearing lubricant on the other hand.

If IndraDyn A motors are operated within the limits specified for radial and axial loads, the mechanical service life of the bearings is

$L_{10h} = 30,000$ operating hours

(calculated according to ISO 281, Version 1993.01)

This is applicable to all IndraDyn A motors provided the following requirements are met:

- The allowed motor load specified in chapter [chapter 9.13 "Bearing Variants and Shaft Load" on page 247](#) is never exceeded.
- The motor is operated under the allowed conditions of use and within the allowed surrounding air temperature range of 0 °C to +40 °C.
- The "mean speed" used over the entire machining cycle complies with the following characteristic curves for the grease service life, where

$$n_m < n_{m(t_f = 30000 \text{ h})}$$

n_m Mean speed

$n_{m(t_f)}$ Mean speed at which a grease service life of 30,000 h can be expected

Fig.9-44: Mean speed (grease service life)

Different loads may have the following effects:

- Early failure of the bearings due to increased wear or mechanical damage.
- Reduced grease service life and therefore early bearing failure.
- Avoid exceeding the load limits.

Mechanical bearing service life with increased radial force

Otherwise, the service life of the bearing is reduced to:

$$L_{10h} = \left(\frac{F_{\text{radial}}}{F_{\text{radial_act}}} \right)^3 \cdot 30,000$$

L_{10h} Bearing service life (according to ISO 281, Version 12/1990)

F_{radial} Determined allowed radial force in N (newton)

$F_{\text{radial_act}}$ Actually acting radial force in N (newton)

Fig.9-45: Calculating the bearing service life L_{10h} if the allowed radial force F_{radial} is exceeded



The actually acting radial force $F_{\text{radial_act}}$ may never be higher than the maximum allowed radial force $F_{\text{radial_max}}$.

9.16 Grease Service Life

The grease service life (t_f) is defined as the time from the point when the bearing is started until it fails as a result of lubrication failure. Unfavorable operating and ambient conditions reduce the grease service life. When the grease service life to be expected (t_{fq}) is determined, it is therefore absolutely necessary that certain reduction factors for unfavorable operating and ambient conditions be taken into account for each single case of application. The following table specifies the reduction factors, which refer to publication no. WL 81 115/4 DA by FAG Kugelfischer AG.

Description	Naming	Influence	Factor	Remark
Influence of dust and moisture on the functional surfaces of the bearing	f_1	Moderate	0.9 ... 0.7	Rexroth offers the "radial shaft sealing ring" as an option for this environment. If this option is used $\Rightarrow f_1 = 1$
		Strong	0.7 ... 0.4	
		Very strong	0.4 ... 0.1	
Influence of abrupt loads, vibrations and oscillations	f_2	Moderate	0.9 ... 0.7	E.g., on machine tools and printing presses
		Strong	0.7 ... 0.4	E.g., on materials handling equipment (portals)
		Very strong	0.4 ... 0.1	E.g., on punches, presses
Influence of an increased bearing temperature	f_3	Moderate (up to 75 °C)	0.9 ... 0.6	The bearing temperature depends on the degree of capacity utilization of the motor. If a special high-temperature grease is used: Capacity utilization 0 ... 70% $\Rightarrow f_3 = 1$ Capacity utilization 71 ... 100% $\Rightarrow f_3 = 0.99 ... 0,7$
		Strong (75 ... 85 °C)	0.6 ... 0.3	
		Very strong (85 ... 120 °C)	0.3 ... 0.1	
Influence of a high load	f_4	P/C = 0.1 ... 0.15	1.0 ... 0.7	If the shaft/bearing is appropriately loaded according to the particular shaft load diagram, the following results for IndraDyn A motors: Load 0 ... 70% $\Rightarrow f_4 = 1$ Load 71 ... 100% $\Rightarrow f_4 = 0,99 ... 0,7$
		P/C=0.15 ... 0.25	0.7 ... 0.4	
		P/C=0.25 ... 0.35	0.4 ... 0.1	
Influence of air currents caused by the bearing	f_5	Minor currents	0.7 ... 0.5	There is no influencing air current in the motor if it is operated properly $\Rightarrow f_5 = 1$
		Strong air currents	0.5 ... 0.1	
If there is a centrifugal effect or if the shaft is vertical depending on the sealing	f_6	Vertical	0.7 ... 0.5	If the motor is installed horizontally $\Rightarrow f_6 = 1$

Fig. 9-46: Grease service life reduction factors

Calculation

$$t_{fq} = t_f \times f_1 \times f_2 \times f_3 \times f_4 \times f_5 \times f_6$$

Fig. 9-47: Reduction factors for calculating the grease service life to be expected



Ensure that the allowed loads mentioned in [chapter 9.13 "Bearing Variants and Shaft Load"](#) on page 247 are not exceeded.

If the grease service life limits the time of use of the motor, the time of use can be prolonged in edge cases by using the standard bearing instead of the rein-

Application Guidelines

forced bearing. However, the higher load of the standard bearing reduces the available mechanical service life to less than 30,000 operating hours.

In this case, the bearing service life must be recalculated by Bosch Rexroth. Contact one of our branch offices and describe your application with all relevant application data (load cycle, axial and radial loads, speeds).

Calculation and design of the bearings is based on standard DIN ISO 281.

The available grease service life of deep-groove ball bearings and cylindrical roller bearings in IndraDyn A motors is illustrated in the following diagrams. The diagrams contain varying characteristic curves, depending on the bearing type.

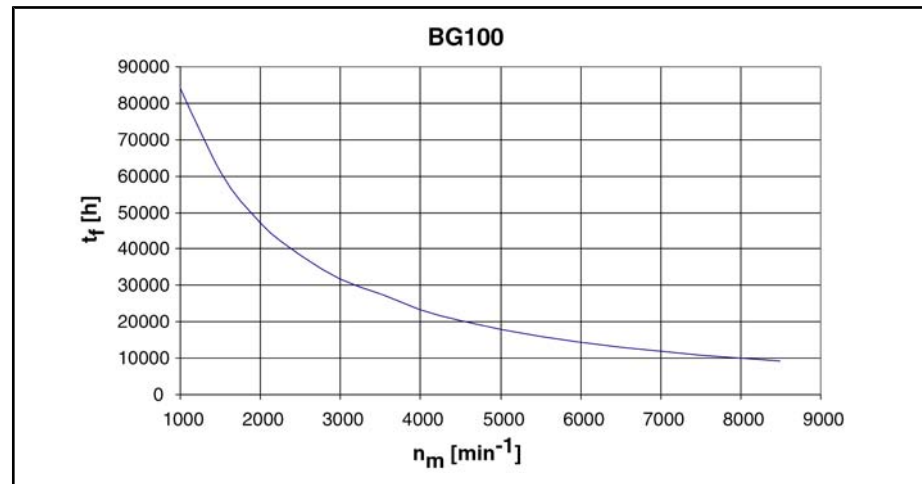
Grease service life with frame size
100

t_f Grease service life (without reduction factors)

n_m Mean speed

Fig. 9-48: Grease service life with frame size 100

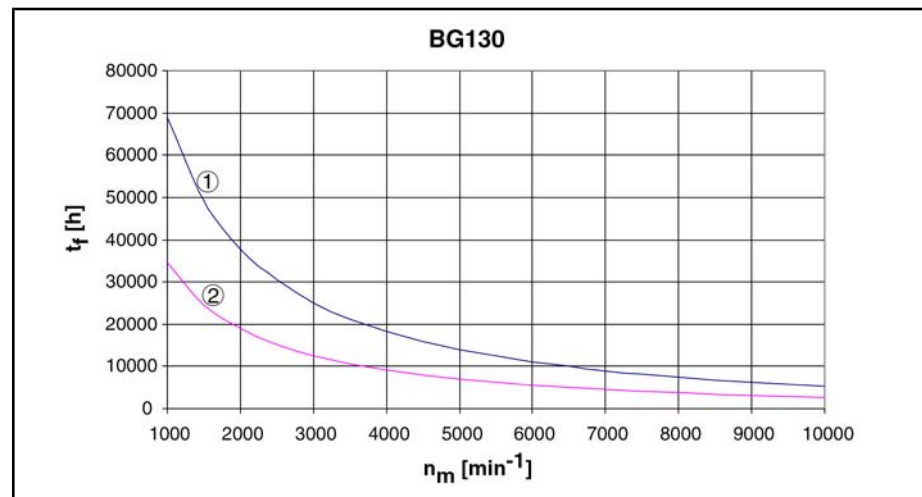
Grease service life with frame size
130

t_f Grease service life (without reduction factors)

n_m Mean speed

① Characteristic curve of bearing N / A / H

② Characteristic curve of bearing V

Fig. 9-49: Grease service life with frame size 130

Grease service life with frame size 160

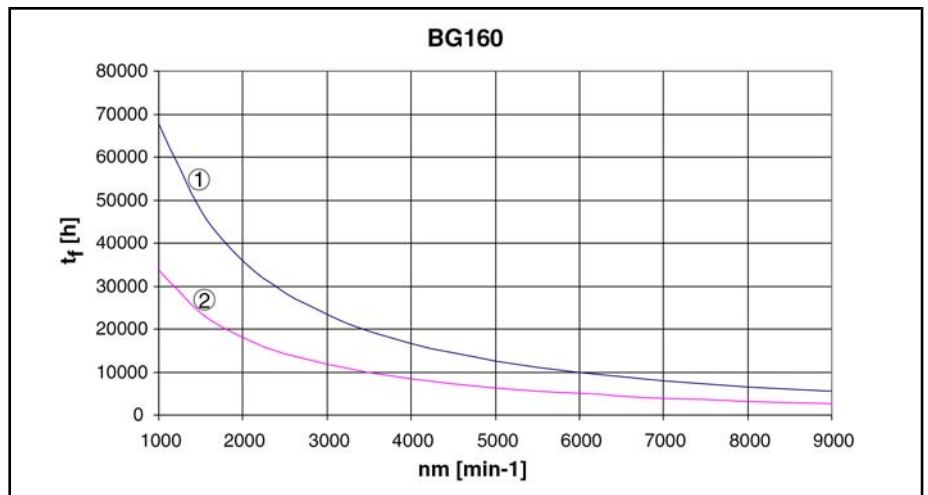

t_f Grease service life (without reduction factors)

n_m Mean speed

① Characteristic curve of bearing N / A / H

② Characteristic curve of bearing V

Fig.9-50: Grease service life with frame size 160

Grease service life with frame size 180

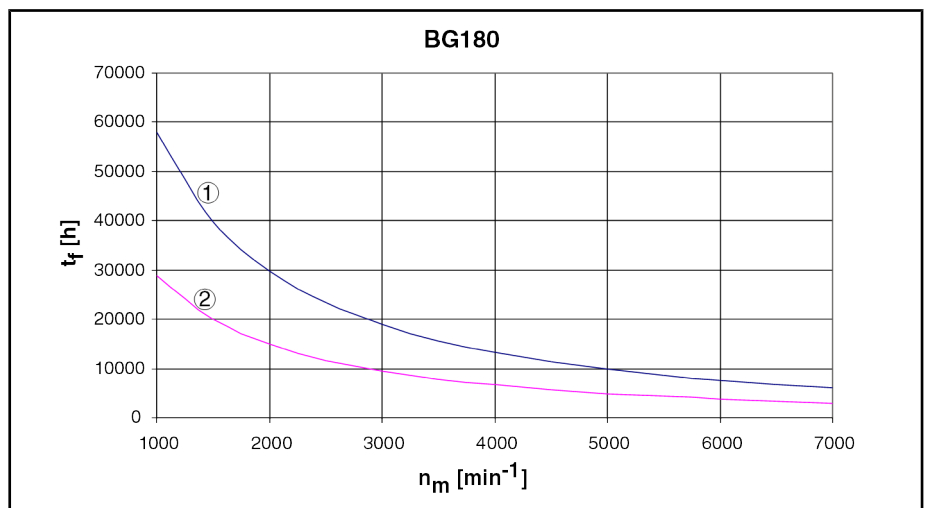

t_f Grease service life (without reduction factors)

n_m Mean speed

① Characteristic curve of bearing N / A

② Characteristic curve of bearing V

Fig.9-51: Grease service life with frame size 180

Application Guidelines

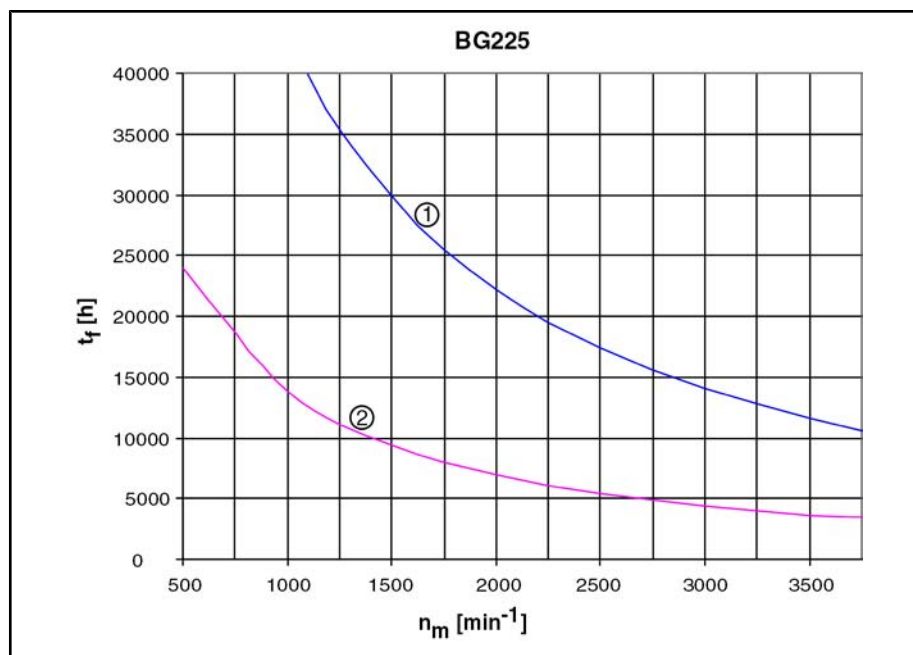
Grease service life with frame size
225

t_f Grease service life (without reduction factors)

n_m Mean speed

① Characteristic curve of bearing N

② Characteristic curve of bearing V

Fig.9-52: Grease service life with frame size 225

9.17 Oscillating Quantity Level

IndraDyn A motors are balanced dynamically and comply with the limits of bearing housing vibrations according to EN 60034-14:2004. The motors are measured in specified velocity levels and in free suspension (see EN 60034-14:2004, chapter 6.2 Free suspension).

The following tables give an overview of the position of the various oscillating quantity levels in connection with other oscillating quantity levels improved and defined by Bosch Rexroth.

In level A, Rexroth IndraDyn A motors basically achieve better values than the values required by EN 60034-14:2004. For this reason, a second characteristic curve is represented that can be considered as a standard for all IndraDyn A motors of this level.

Oscillating quantity level A (according to EN 60034-14:2004) is only intended to represent the maximum values of this level allowed according to EN 60034-14. If the degree of mechanical smooth running must meet special requirements, level B (according to EN 60034-14:2004) and level C (factory standard) are available for certain motors.



Please also observe the information on the oscillating quantity level in the type code of the particular motor.

Oscillating quantity level of
 MAx100 ... 130

Table with allowed oscillating velocities for frame sizes 100 ... 130

Speed	Oscillating velocity in mm/s			
	Level A	Level B	Level C	Level A (allowed values according to EN 60034-14:2004)
600 ... 1,800	0.71	0.44	0.28	1.01
1,800 ... 3,600	1.12	0.7	0.45	1.6
3,600 ... 6,000	1.8	1.1	0.71	2.52
6,000 ... 9,000	2.8	1.77	1.12	4.06
9,000 ... 12,000	4.5	2.76	1.8	6.31
12,000 ... 15,000	7.1	4.44	2.8	10.14

Fig.9-53: Allowed oscillating velocities for frame sizes 100 ... 130

Application Guidelines

Vibration severity grade diagram for frame size 100 ... 130

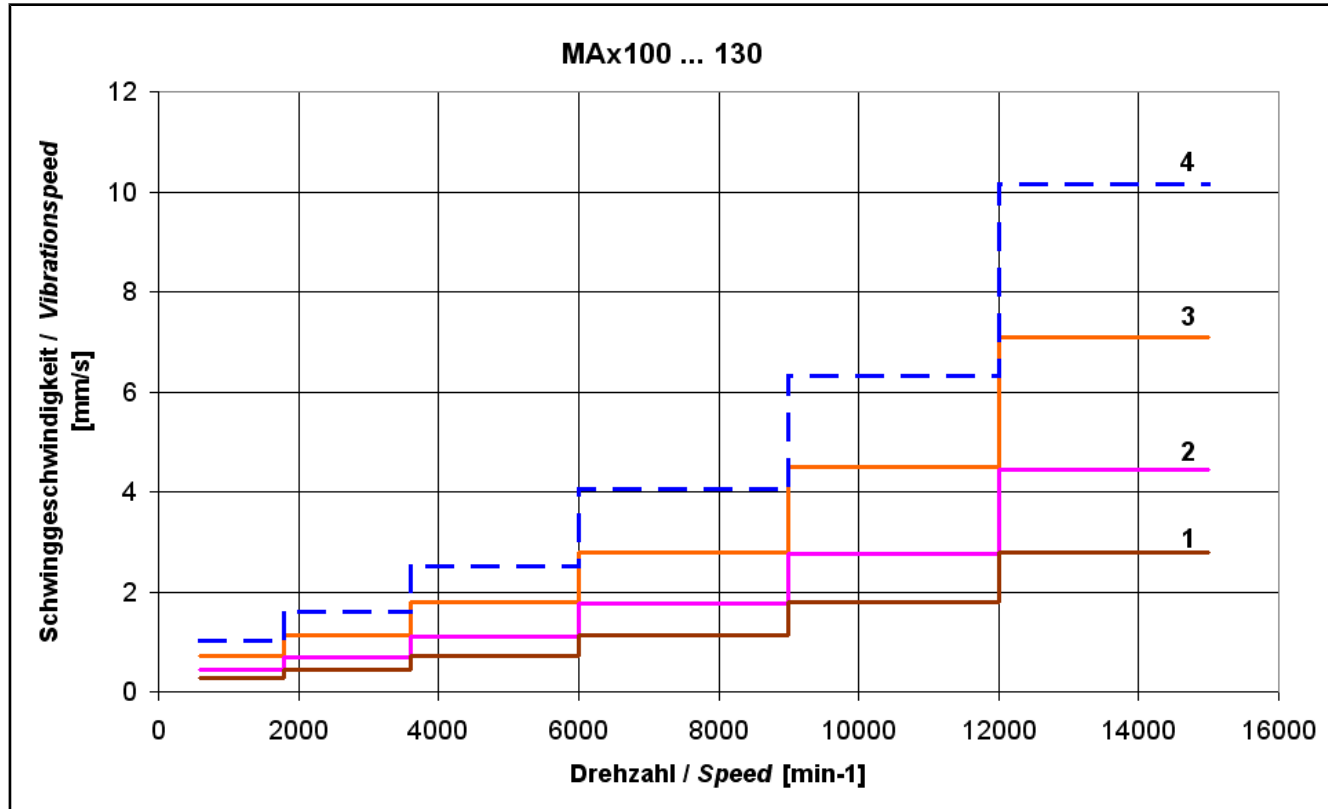

- ① Oscillating quantity level C (corresponding to Bosch Rexroth factory standard)
- ② Oscillating quantity level B (according to EN 60034-14:2004)
- ③ Oscillating quantity level A (corresponding to Bosch Rexroth factory standard)
- ④ Oscillating quantity level A (according to EN 60034-14:2004)

Fig. 9-54: Graphical diagram of the oscillating quantity levels of frame sizes 100 ... 130

Oscillating quantity level of Mx160 ... 225

Table with allowed oscillating velocities for frame sizes 160 ... 225

Speed	Oscillating velocity in mm/s			
	Level A	Level B	Level C	Level A (allowed values according to EN 60034-14:2004)
600 ... 1,800	1.2	0.7	0.45	1.39
1,800 ... 3,600	1.8	1.1	0.71	2.2
3,600 ... 6,000	2.8	1.74	1.12	3.47
6,000 ... 9,000	4.5	2.79	1.8	5.58
9,000 ... 12,000	7.1	4.34	2.8	8.68
12,000 ... 15,000	11.2	6.97	4.5	13.94

Fig. 9-55: Allowed oscillating velocities for frame sizes 160 ... 225

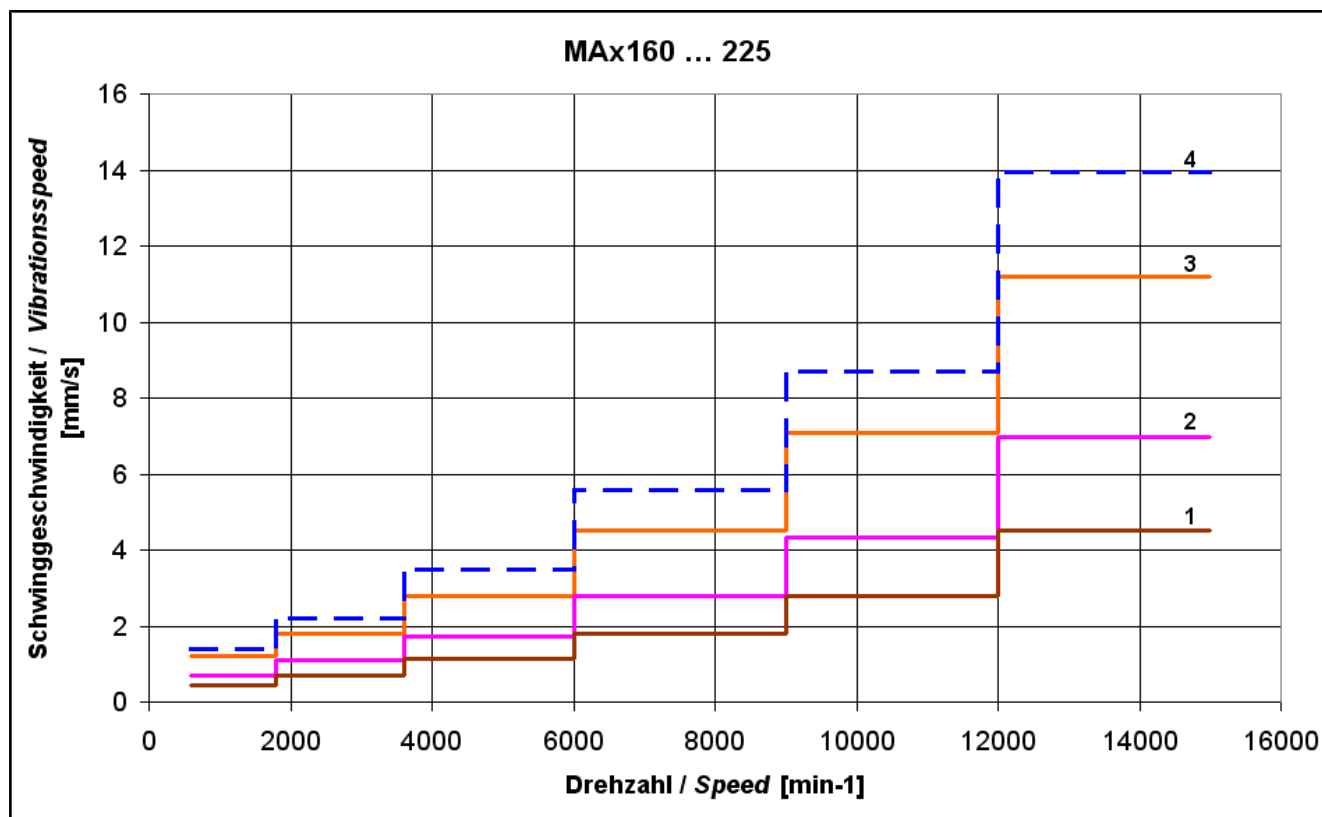

- ① Oscillating quantity level C (corresponding to Bosch Rexroth factory standard)
- ② Oscillating quantity level B (according to EN 60034-14:2004)
- ③ Oscillating quantity level A (corresponding to Bosch Rexroth factory standard)
- ④ Oscillating quantity level A (according to EN 60034-14:2004)

Fig. 9-56: Overview of the oscillating quantity levels of frame sizes 160 ... 225

For more detailed information, e.g., on measuring variables, machine installation or measurement conditions, please refer to EN 60034-14.



Please note that the vibration behavior of attached or driven machine elements can also generate reactions to the motor which lead to early wear or failure in unfavorable cases.

Due to the system-specific influences on the vibration behavior of the overall system, the machine manufacturer must determine the specific circumstances. In certain cases, the machine elements to be driven must be balanced such that there will be no resonances or reactions.



The vibration behavior of the motor and the machine elements should be taken into account as early as during the plant design phase.

Application Guidelines

9.18 Explosion Protection

9.18.1 Motors in Ex-px d Design (Type Code Option "M6" or "S6")



Ex-type motors (Ex-px d) are certified as explosion-protected devices.

Motors having this degree of protection are devices of device group II, category 2G, Directive 94/9/EC, Annex II, Chapter 2.2.1, and may only be used in environments in which

- gases, vapors or mists can generate an explosive atmosphere **rarely and briefly**,
- gases, vapors or mists can generate an explosive atmosphere **occasionally**.

For this reason, the user has to design and manufacture the plant and the components such that ignition sources are avoided even in the event of frequently occurring device malfunctions or faulty operating states which must usually be expected.



The motor that is approved for Ex-areas and is identified accordingly is merely a part of a drive concept. In these areas, the motors may only be commissioned with a control unit which is classified and approved according to the conditions of the potentially explosive atmosphere. Please be absolutely sure to also follow the information and instructions on the configuration of the control unit selected for purging the motor as early as during the project planning phase and prior to commissioning the plant.

Observe the required selection criteria in the type code of the particular motor as well as the additional data, e.g., on the selection, the protection principle and the labeling of the motors in [chapter 13.5 "Selecting and Labeling Ex-type Motors"](#) on page 297.

9.19 Acceptances and Approvals

9.19.1 CE Mark

Declarations of conformity confirming the structure and the compliance with applicable EN standards and guidelines are available for IndraDyn A motors. If necessary, the declarations of conformity can be requested from the responsible sales office.

The CE mark is attached to the motor name plate of IndraDyn A motors.



Fig.9-57: CE mark

9.19.2 UR/cUR Listing

IndraDyn A motors were presented to "Underwriters Laboratories Inc.®" and have been approved by this UL authority.

The motors are correspondingly identified on the motor name plate.



Fig.9-58: cUR mark

10 Handling and Transport

10.1 Condition on Delivery

10.1.1 General Information

IndraDyn A motors are delivered in wooden crates or in cartons. Packing units on pallets are secured by retaining straps.

CAUTION

When being cut open, the retaining straps may make uncontrolled movements which may result in injuries.

⇒ Stay away from the retaining straps and cut them open with particular care.

Motor shaft and plug connections are provided with protective sleeves at the factory. Remove these protective sleeves only immediately before starting assembly.

10.1.2 Factory Test

All IndraDyn A motors are subjected to the following and other tests:

- | | |
|------------------------|--|
| Electrical test | <ul style="list-style-type: none">• High-voltage test according to EN 60034-1 (pursuant to VDE 0530-1)• Insulation resistance according to EN 60204-1/1.92, Section 20.3• Protective conductor connection according to EN 60204-1/1.92, Section 20.3 |
| Mechanical test | <ul style="list-style-type: none">• Concentricity and position tolerances of shaft end and mounting flange according to DIN 42955• Vibration measurement according to DIN 2373 |

10.1.3 Test Performed by the Customer

Since all IndraDyn A motors are subjected to a standardized inspection procedure, the customer does not have to perform high-voltage tests. Repeated high-voltage tests may damage both motors and components.

NOTICE

Improperly conducted high-voltage tests may destroy motor components. This will invalidate the warranty!

⇒ Avoid repeated tests.

⇒ Comply with the requirements of EN 60034-1 (pursuant to VDE 0530-1).

10.2 Identification

The total scope of a delivery is specified on the delivery or consignment note. However, the contents of a delivery may be distributed over several packages. Each individual package can be identified using the shipment label attached on the outside. In addition, each device has an individual name plate containing the device designation and technical data.



After having received the goods, compare the supplied type with the ordered type. Immediately file complaints about non-compliances.

Handling and Transport

10.3 Labeling

The type designation of the complete product is composed based on the options selected. These codes are printed on the name plate along with other product data.

The code and the serial number allow unique identification of each Bosch Rexroth product.

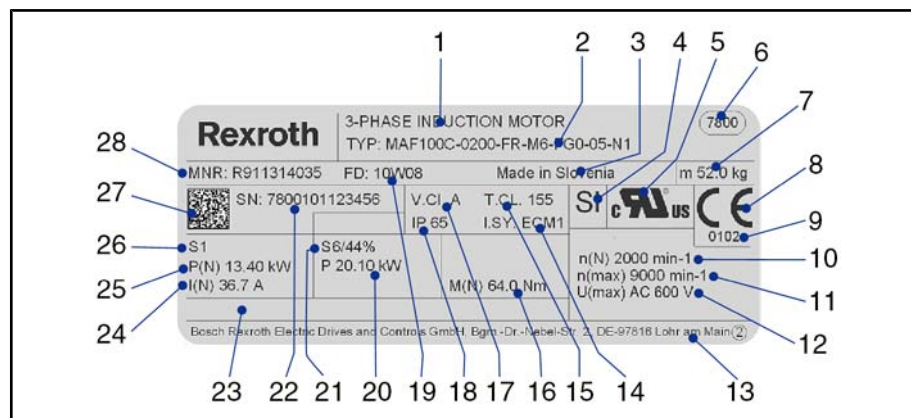

1	Machine type
2	Type designation
3	Origin
4	Safety technology according to EN 61508-1
5	UL mark
6	Manufacturer's factory
7	Motor mass in kg
8	CE mark
9	Test body's ID code
10	Rated speed
11	Maximum speed
12	Maximum input voltage
13	Company address
14	Insulation system
15	Thermal temperature class
16	Rated torque
17	Vibration severity grade
18	Degree of protection through housing
19	Manufacturing date
20	Motor power in operation mode S6
21	Operation mode S6/44%
22	Serial number
23	Field for holding brake (optional) with holding torque, rated voltage, rated current
24	Rated current in delta connection in operation mode S1
25	Rated power in delta connection in operation mode S1
26	Operation mode S1
27	Rexroth bar code
28	Part number

Fig. 10-1: Example name plate MAF

IndraDyn A motors are each delivered with 2 name plates.

Attach the second name plate to the machine at a well visible place. This allows reading the motor data at any time without having to reach the motor at places which are difficult to access.

Before submitting inquiries to Bosch Rexroth, please always note down the complete type designation and serial number.

10.4 Transport and Storage

10.4.1 General Information

NOTICE

Improper handling may result in damage or injuries and invalidate the warranty.

- Protect the products against moisture and corrosion.
 - Avoid putting the products under mechanical load. Do not throw, tilt or drop the products.
 - Only use lifting equipment suitable for the weight of the motor.
 - Never lift the motor by the fan housing.
 - Use suitable protective devices and wear protective clothing when transporting the device.
-

10.4.2 Transport-related Guidelines

To protect the motor against dirt, dust, etc., Bosch Rexroth recommends to transport the motor in its original packaging

- until it has reached its intended installation site and
- until it is actually installed into the machine.

To lift the motor out of the transport crate or to install it into the machine, use the transport or lifting eye bolts provided at the motor.

The lifting eye bolts at least meet the requirements of DIN 580. Whenever intending to transport the motor, ensure that the lifting eye bolts are completely screwed down to the stop face and are not overloaded by the selected lifting equipment and lifting method.



When transporting the motors by means of the attache lifting eye bolts, ensure to meet the requirements of DIN 580. Failure to comply with the requirements of this standard may overload the lifting eye bolts and result in personal injury and/or product damage.

Based on DIN EN 60721-3-2, the following table specifies the classifications and limit values to which our products may be exposed while they are transported by land, water or air. Also read the detailed description of the classifications to ensure that all factors which are specified in the respective class are taken into account.

Handling and Transport

Environmental condition classes allowed for transport according to DIN EN 60721-3-2

Classification type	Allowed class
Classification of climatic environmental conditions	2K2
Classification of biological environmental conditions	2B1
Classification of chemically active substances	2C2
Classification of mechanically active substances	2S2
Classification of mechanical environmental conditions	2M1

Fig. 10-2: Environmental condition classes allowed for transport

To provide a better overview, the table below gives some essential environmental factors of the aforementioned classifications. Unless otherwise stated, the values specified correspond to the values of the respective class. However, Bosch Rexroth reserves the right to adjust these values to future experiences or changed environmental conditions at any time.

Allowed transport conditions

Environmental factor	Symbol	Unit	Value
Temperature	T_T	°C	-20 ... +80 ¹⁾
Air humidity (relative humidity, not to be combined with rapid changes in temperature)	φ	%	75 (at +30 °C)
Occurrence of salt mist			Not allowed ¹⁾

1) In contrast to DIN EN 60721-3-2

Fig. 10-3: Allowed transport conditions



If necessary, liquid-cooled motors should be drained of coolant prior to transport in order to avoid frost damage.

Transport by air

If motor components with permanent magnets are shipped by air, the DGR (**D**angerous **G**oods **R**egulations) of the IATA (International Air Transport Association) for hazardous materials of class 9 which also include magnetized substances and objects must be observed. For example, these regulations are applicable for

- Secondary parts of synchronous linear motors
- Rotors of synchronous kit motors
- Rotors of synchronous housing motors (if shipped as motor components, i.e., separated from the stator or motor housing in case service work is required)

For information on the maximum allowed magnetic strengths and methods of measuring such magnetic field strengths, please refer to the current IATA DGR (chapter 3.9.2.2).

10.4.3 Storage-related Guidelines

Storage conditions In principle, Bosch Rexroth recommends that all components be stored as follows until they are actually installed into the machine:

- In their original packaging
- At a dry and dustfree place
- At room temperature
- Free of vibration and oscillation
- Protected against light and direct solar radiation

Our motors may be equipped with protective sleeves and covers at the factory. These sleeves and covers must remain on the motor while the latter is transported. Remove these parts only immediately before starting assembly.

Based on DIN EN 60721-3-1, the following table specifies the classifications and limit values to which our products may be exposed as long as they are stored. Also read the detailed description of the classifications to ensure that all factors which are specified in the respective class are taken into account.

Environmental condition classes allowed for storage according to DIN EN 60721-3-1

Classification type	Class
Classification of climatic environmental conditions	1K2
Classification of biological environmental conditions	1B1
Classification of chemically active substances	1C2
Classification of mechanically active substances	1S1
Classification of mechanical environmental conditions	1M2

Fig. 10-4: Environmental condition classes allowed for storage

To provide a better overview, the table below gives some essential environmental factors of the aforementioned classifications. Unless otherwise stated, the values specified correspond to the values of the respective class. However, Bosch Rexroth reserves the right to adjust these values to future experiences or changed environmental conditions at any time.

Environmental condition classes allowed for storage according to DIN EN 60721-3-1

Environmental factor	Symbol	Unit	Value
Air temperature	T_L	°C	-20 ... +60 ¹⁾
Relative air humidity	φ	%	5 ... 95
Absolute air humidity	ρ_w	g/m ³	1 ... 29
Moisture condensation	--	--	Not allowed
Formation of ice / icing	--	--	Not allowed
Direct solar radiation	--	--	Not allowed ¹⁾
Occurrence of salt mist	--	--	Not allowed ¹⁾

1) In contrast to DIN EN 60721-3-1

Fig. 10-5: Allowed storage conditions

Handling and Transport



If necessary, liquid-cooled motors should be drained of coolant before they are put back in storage, in order to avoid frost damage.

Motor storage times

Irrespective of the storage time - which may also go beyond the warranty time for our products - their function remains preserved when additional measures are initiated and taken during commissioning. However, this does not include any additional warranty claim.

Storage time	Measures during commissioning
< 1 year	Resurface the holding brake
1 ... 5 years	<ol style="list-style-type: none"> 1. Verify that electric contacts are free from corrosion 2. Let the motor run in without load for one hour at 800 ... 1000 rpm 3. Resurface the holding brake
> 5 years	<ol style="list-style-type: none"> 1. Exchange bearings 2. Exchange encoders 3. Resurface the holding brake 4. Verify that electric contacts are free from corrosion

Fig.10-6: Measures before commissioning motors in long-term storage

Cables and connectors

Storage time	Measures to be taken before commissioning
< 1 year	None
1 ... 5 years	⇒ Verify that electric contacts are free from corrosion
> 5 years	⇒ Exchange cables if you detect porous spots on the cables or cable jackets; otherwise, verify that electric contacts are free from corrosion

Fig.10-7: Measures to be taken before commissioning cables and connectors in long-term storage

11 Installation

11.1 Safety

WARNING

Risk of injury due to live parts! Heavy loads must be lifted!

- Install the motors only when they are de-energized and not connected electrically.
- Use suitable lifting equipment and protective devices and wear protective clothing when transporting the motor.
- Do not lift or move the motor by the fan unit.
- Please observe the safety-related guidelines in the preceding chapters and the transport-related guidelines in chapter [chapter 10 "Handling and Transport"](#) on page 271.

Carry out all working steps with particular care to minimize the risk of accidents and damage.



Some of the IndraDyn A motors of frame size 130 and higher feature additional threaded holes on their longitudinal sides where eyelets can be inserted (for details, see dimension drawing). Additional eyelets can simplify the transport and handling of the motors.

11.2 Mechanical Attachment

11.2.1 Motor Attachment

Mounting screws

To attach the motors properly and safely to the machine, Bosch Rexroth recommends the following screws and washers for attachment.

- **Motor frame size 100**
 - pan head screw DIN EN ISO 4762 - M12 x ... - 8.8
and
 - washer DIN EN ISO 28738
- **Motor frame size 130 ... 225**
 - hexagon screws DIN EN ISO 4014 - M... x ... - 8.8
or
 - pan head screw DIN EN ISO 4762 - M... x ... - 8.8
and
 - washer DIN EN ISO 7090 - ... - 200 HV



If screws and washers other than the recommended ones are used, the property class of the screws and the hardness class of the washers must be equivalent in order to ensure that the required tightening torques are transmitted (see [fig. 11-2 "Mounting holes and screw tightening torques"](#) on page 278).

Installation

Attachment types

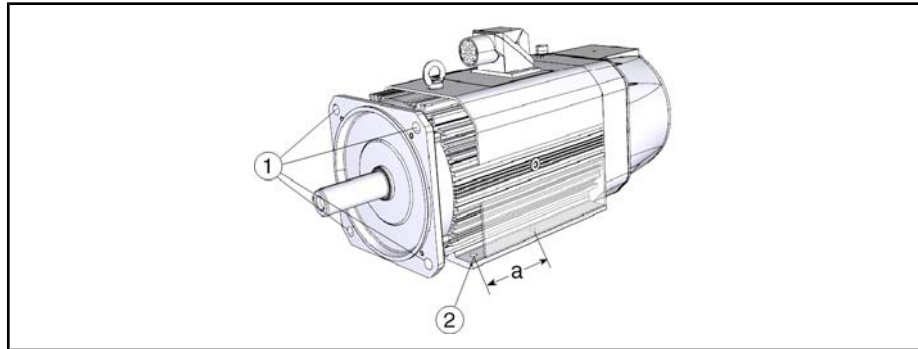

- ① Holes for flange assembly
 ② Mounting feet for foot assembly
 a For hole clearance "a", refer to the table of the particular motor dimension drawing

Fig. 11-1: Motor attachment types

At the factory, IndraDyn A motors are manufactured either for flange assembly (B05) or foot assembly (B35). The particular dimension drawing contains details on the position of the mounting holes. In general, the following assignment is applicable for attaching the motors:

MAD/MAF	B05 (flange assembly)			B35 (foot assembly)		
	Hole	Screw (8.8)		Hole	Screw (8.8)	
	Ø [mm]	Type	M_A [Nm] with μ_G 0.12	Ø [mm]	Type	M_A [Nm] with μ_G 0.12
100	14	M12	84	11	M10	48
130	18	M16	206	12	M10	48
160				14	M12	84
180				14,5		
225				22	M20	415

M_A Tightening torque in newton meters

μ_G Coefficient of friction

Fig. 11-2: Mounting holes and screw tightening torques

Foot assembly

Before attaching the IndraDyn A motors according to the foot assembly method, observe the clearance from the center of the motor shaft to the bottom edge of the foot specified in the particular motor dimension drawing. Compare this clearance with the connection clearance actually present on the machine.



The mounting holes and clearances correspond to the general tolerance according to ISO 2768-m.

Before attaching the motor to the machine, align the motor such that the center line of the motor shaft is flush with the center line of the connection shaft.

Also note the information on this mounting type provided in [chapter 9.6.2 "Foot Assembly" on page 228](#).

If attaching the motors according to the foot assembly method, proceed as follows:

1. MAD130 ... 225: Dismount the lower lateral air baffles to have free access to the mounting holes.

2. Align the motor such that the center line of the motor shaft is flush with the center line of the connection shaft of the machine. Support the motor on sheet steel strips when aligning it.
3. Firmly connect the motor to the machine (for tightening torques, see [fig. 11-2 "Mounting holes and screw tightening torques"](#) on page 278).
4. MAD130 ... 225: Reattach the air baffles to the motor.

Frame size	Motor attachment type	Number of mounting holes	Roughness height of the screwing surface to the machine
100	Mounting feet (4 pcs.)	4	Rz32
130	Foot plates (2 pcs.)		
160	Mounting feet (4 pcs.)		
180	Via stator profile		
225	Mounting feet (4 pcs.)		

Fig. 11-3: Foot assembly

11.2.2 Preparing Assembly

Enter all taken measures in the commissioning log.

Prepare motor assembly as follows:

1. Check the components for visible damage. Defective components may not be mounted.
2. Ensure that the dimensions and tolerances of the plant are suitable for motor attachment (for details, see dimension drawing).
3. Ensure that the motor can be assembled in a clean, dry and dustfree environment.
4. Keep tools and auxiliary materials as well as measuring and testing equipment ready at hand.
5. Inspect all components, mounting surfaces and threads to ensure they are clean.
6. Ensure that the machine-sided receptacle for the motor flange has no burrs.
7. Remove the protective sleeve from the motor shaft. Keep the sleeve for later use.

11.2.3 Assembling the Motor

Observe the following guidelines:

- In case of flange assembly: Avoid clamping or jamming the motor-sided centering collar.
- In case of flange assembly: Avoid damaging the plant-sides receptacle fit.
- In case of foot assembly: Align the center line of the motor shaft flush with the connection shaft of the machine. Also observe the guidelines regarding foot assembly in this chapter.
- Connect the motor to the machine (observe tightening torques).
- Check whether the connection is firm and accurate before carrying out any further steps.

After having assembled the motor mechanically, prepare it for electrical connection.

Installation

11.3 Electrical Connection

11.3.1 General Information

Use ready-made cables by Bosch Rexroth. These cables have numerous benefits, e.g., extreme resilience and resistance as well as EMC-compliant design.

- Connect IndraDyn A motors electrically as described in chapter 8 "Connection Methods" and Ex-type motors as described in chapter 13 "Motors for Potentially Explosive Atmospheres".



Circuit diagrams of the plant are created based on the connection diagrams of the product documentation. The drive components may only be connected in the machine according to the machine manufacturer's plant circuit diagrams.

11.3.2 Additional Ground Conductor on Motors

When being connected, some of the motors must be equipped with an additional ground conductor. For more information about this additionally required ground conductor, please refer to [chapter 8.2.2 "Additional Ground Conductor on Motors" on page 208](#).

12 Operating of IndraDyn A Motors

12.1 Commissioning

12.1.1 General Information

NOTICE

Property damage caused by errors while controlling motors and moving parts! Unclear operating states and product data!

- Do not commission the motors if connections, operating states or product data are unclear or faulty.
 - Do not commission the motors if safety devices and monitoring units for the plant are damaged or not in operation.
 - Damaged products may not be operated.
 - Contact Bosch Rexroth if you need additional information or support during commissioning.
-

The following commissioning instructions refer to IndraDyn A motors if they are a part of a drive system with controller and control unit.

12.1.2 Preparation

1. Keep the documentations of all products used ready at hand.
2. Enter all taken measures in the commissioning log.
3. Check the products for damage.
4. Check all mechanical and electrical connections.
5. Activate the safety devices and monitoring units of the plant.

12.1.3 Steps Required

After having met all of the above requirements, carry out the following steps:

1. Activate the fan at the MAD motor or the external cooling system supplying the MAF motor and check them to verify that they are in a proper condition. Follow the manufacturer's instructions.
2. Commission the drive system according to the instructions in the particular product documentations. The associated information can be found in the functional descriptions of the drive controllers.
3. Enter all taken measures in the commissioning log.



Additional steps may be required to commission controllers and control units. Commissioning of the motor does not include checks for proper functioning and performance of the plant. These checks must be carried out while the machine is commissioned as a whole. Please observe the machine manufacturer's instructions and regulations.

12.2 Shutdown

Proceed as follows in case of failures of the motors or if you have to take maintenance measures or shut down the motors:

1. Observe the instructions in the machine documentation.
2. Decelerate the drive in a controlled manner using the machine-sided control commands.
3. Switch off the power and control voltage of the controller.
4. **Only applicable to MAD motors:** Switch off the motor protection switch for the motor fan.
Only applicable to MAF motors: Switch off the external coolant supply.
5. Switch off the main switch of the machine.
6. Secure the machine against unforeseeable movements and against unauthorized operation.
7. Wait until the discharge time of the electrical systems has elapsed and then disconnect all electrical connections.
8. Before dismounting the motor and, if applicable, the fan unit, secure them to ensure they cannot drop or move, and detach mechanical connections only thereafter.
9. Enter all taken measures in the commissioning log.

12.3 Disassembly

WARNING

Errors in the control of motors and work on moving elements may result in fatal injuries!

- Work on machines is only allowed if they are secured and while they are not running.
- Before starting to eliminate the failure, switch off the controller and the machine and wait until the discharge time of the electrical systems has elapsed.
- Before starting disassembly, secure the machine against unforeseeable movements and against unauthorized operation.
- Before dismounting the motor and, if applicable, the supply lines, secure them to ensure they cannot drop or move, and detach mechanical connections only thereafter.
- Do not disconnect coolant lines as long as they are still under pressure (not applicable if the optional "quick coupling" is used).

1. Observe the instructions in the machine documentation.
2. Observe the safety-related guidelines and carry out all steps according to the instructions given under "Shutdown" above.
3. Before dismounting the motor and, if applicable, the supply lines, secure them to ensure they cannot drop or move, and detach mechanical connections only thereafter. Discharge the coolant ducts at MAF motors.
4. Dismount the motor from the machine. Store the motor appropriately.
5. Enter all taken measures in the commissioning log and the machine maintenance schedule.

12.4 Maintenance

12.4.1 General Information

Asynchronous motors of the IndraDyn A series are maintenance-free as long as they operated under the operating conditions specified and during the given service life. However, operation under unfavorable conditions can lead to limitations in availability.

- Increase the availability of the motors by regular preventive maintenance measures. Observe the machine manufacturer's instructions in the machine maintenance schedule and the maintenance measures described below.
- Enter all maintenance measures in the machine maintenance schedule.

12.4.2 Measures

⚠ WARNING

Risk of injury from moving elements! Risk of injury from hot surfaces!

- Do not carry out any maintenance measures while the machine is running.
- Before starting maintenance, switch off the controller and the machine and wait until the discharge time of the electrical systems has elapsed.
- While carrying out maintenance work, secure the machine such that it cannot restart or be used by unauthorized persons.
- Do not work on hot surfaces.

Bosch Rexroth recommends the following maintenance measures based on the machine manufacturer's maintenance schedule:

Measure	Interval
Only applicable to MAF motors: Check the coolant system for proper functioning.	As specified in the machine maintenance schedule, however, at least every 1000 operating hours.
Only applicable to MAD motors: Check the motor fan and the air circulation for proper functioning.	As specified in the machine maintenance schedule, however, at least every 1000 operating hours.
Check all mechanical and electrical connections.	As specified in the machine maintenance schedule, however, at least every 1000 operating hours.
Check the machine for smooth running, vibrations and bearing noise.	As specified in the machine maintenance schedule, however, at least every 1000 operating hours.
Remove dust, chips and other dirt from motor housing, cooling fins and connections.	Depending on the degree of soiling, however, not later than after one operating year.

Fig. 12-1: Maintenance measures

12.4.3 Motor Fan

General Information

There may be cases when the fan unit must be dismantled for maintenance measures or troubleshooting.

Operating of IndraDyn A Motors

- This work may only be carried out by specialized staff.
- When dismantling the fan unit, keep all strips, screws and nuts with which it is attached.

In parts, the housings of the fan units consist of several screwed elements. Only unscrew the screws that are marked as such.

⚠ CAUTION

Immediately after the motor has been operated, high temperatures must be expected on the fan housing! Risk of burns!

- Ensure adequate contact protection and wait until the motor has cooled down.
- Ensure that there are no combustible and flammable materials in the environment of the hot fan.

⚠ CAUTION

While voltage is applied, the motor restarts automatically, e.g., after a power failure. Risk of injuries!

- Do not stay within the danger zone of the device.
- When working on the device, switch off the line voltage and ensure that it cannot be reactivated.
- Wait until the device has come to a standstill.

⚠ WARNING

Rotating device!

If coming into contact with rotor or impeller, body parts may be crushed! Risk of injuries!

- Protect the device against contact. Before starting work on the plant/machine, wait until all parts have come to a standstill.
- Do not wear jewels or loose or dangling garments when working on moving parts.
- Wear a cap to protect long hair.

General fan maintenance steps:

1. Switch off the machine and disconnect the electrical fan connection.
2. Before unscrewing mounting screws, secure the fan unit such that it cannot drop and carefully remove the fan unit from the motor.
3. Reattach the fan unit after having cleaned or visually inspected the motor or after troubleshooting (see guidelines below). Protect all mounting screws with LOCTITE 243 (screwlock) and reestablish all connections.

When attaching the power supply connector, particularly ensure the following:

There is a seal between the connector and the plug on the fan. Ensure that the cable cannot put the plug under tensile load in order to avoid inadequate tightness of this plug connection. If necessary, attach the connecting cable in flush direction with the plug and provide strain relief at a close distance.

4. Check the motor fan and the air circulation for proper functioning.
5. Enter all maintenance measures in the machine maintenance schedule.

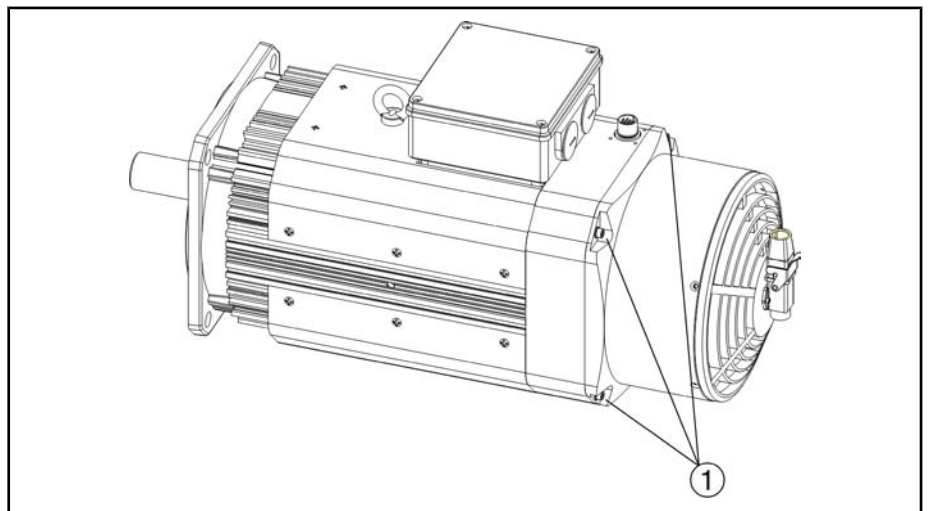

① Mounting screws (4 pcs.)

Fig. 12-2: MAD fan (illustrated example: MAD130)

Required visual inspections of the fan

Inspection	Interval
Line insulation	As specified in the machine maintenance schedule, however, at least every 6 months
Attachment of connecting lines	
Lining of contact protection	
Ventilator for damage	
Attachment of ventilator	

Fig. 12-3: Visual fan inspection

Operating of IndraDyn A Motors

Troubleshooting guidelines

Failure/fault	Possible cause	Possible action
Fan motor not running	Mechanical blockage	Switch off and de-energize the motor and remove the mechanical blockage.
	Wrong line voltage	Check the line voltage and reestablish voltage supply.
	Faulty connection	Correct the connection.
	Motor winding interrupted	Exchange the device.
Impeller running untrue	Imbalance of rotating parts	Clean the device. If there is still an imbalance after cleaning, exchange the device.
Overtemperature of fan motor	Surrounding air temperature too high	If possible, reduce the surrounding air temperature.
	Unallowed operating point	Check the operating point.
	Inadequate cooling	Improve the cooling system.
Please contact your Rexroth sales partner in case of other failures.		

Fig. 12-4: Troubleshooting guidelines

12.4.4 Coolant Supply

There may be cases when the coolant supply must be dismantled for maintenance measures or troubleshooting.

- This work may only be carried out by specialized staff.
- Do not carry out any maintenance measures while the machine is running. Observe the safety-related guidelines.
- Protect open supply lines and connections such that dirt and contaminants cannot enter.

12.4.5 Servicing and Commissioning Holding Brakes

Before installing the motor, check the holding brake to ensure it is functioning properly.

Before initial startup

Measure the holding torque of the brake and resurface the holding brake if necessary.

Proceed as follows:

1. De-energize the motor and ensure it cannot be restarted.
2. Measure the transmittable holding torque of the holding brake using a torque wrench. The holding torque of the brakes is specified on the data sheets.
3. Once the holding torque specified on the data sheets is reached, the holding brake is ready for operation.



If the holding torque specified on the data sheets is **not reached**, the holding brake must be resurfaced as described in step 4.

4. Resurfacing:

Recommended resurfacing	
Interval	1x
Resurfacing speed	100 min ⁻¹ / duration 30 s
Program	Supplied with 500 ms clock pulses

Fig. 12-5: Recommended resurfacing of motor holding brakes

Once the holding torque specified on the data sheets is reached, the holding brake is ready for operation.

Operating of IndraDyn A Motors

If the holding torque specified on the data sheets is **not reached**, the holding brake must be resurfaced as described in step 4.

If the specified holding torque is not reached after the holding brake has been resurfaced the second time, the holding brake is not operational. In this case, please contact Bosch Rexroth Service.

During operation If holding brakes are required only sporadically in the operating phase (brake cycle > 48 h), film rust may form on the brake surfaces.

To prevent the holding torque from falling below the specified value, we recommend that you proceed as follows:

Recommended resurfacing	
Interval	1x in 48 h
Resurfacing speed	100 min ⁻¹
Number of resurfacing revolutions	1

Fig. 12-6: Recommended resurfacing of motor holding brakes



- The brake does not have to be resurfaced during normal operation. It is sufficient to switch on the brake two times a day by removing the controller enable signal.
- Options of automatically implementing the resurfacing routine in the program run are described in the particular drive controller documentation.

12.5 Troubleshooting

12.5.1 General Information

WARNING

Risk of injury from moving elements! Risk of injury from hot surfaces!

- Do not carry out any maintenance measures while the machine is running.
- Before starting to eliminate the failure, switch off the controller and the machine and wait until the discharge time of the electrical systems has elapsed.
- While carrying out maintenance work, secure the machine such that it cannot restart or be used by unauthorized persons.
- Do not work on hot surfaces.

Possible causes for failures of IndraDyn A motors can be restricted to the following areas:

- Motor cooling circuit or fan function and temperature behavior
- Internal temperature sensor
- Motor encoder or encoder connection
- Mechanical motor damage
- Mechanical connection to the machine

The encoder connection and the temperature sensor are monitored by the controller or the control unit; corresponding diagnostic messages are displayed. Observe the guidelines in the particular documentation.

Operating of IndraDyn A Motors

The sections below describe examples of some fault states along with possible causes. The list is not exhaustive.

12.5.2 Temperature on Motor Housing too High

State The housing temperature of the motor rises to exceptionally high values.

NOTICE

Restarting after excessive motor temperature may damage the motor or the machine.

- Liquid-cooled motors may not be restarted or supplied with cold coolant immediately after a failure of the cooling system or an increased motor temperature. Risk of damage!
- Before restarting the motor, wait until the motor temperature has dropped to approx. 40 °C.

Possible causes

1. Failure or fault in the fan or cooling system.
2. Original machining cycle has been changed.
3. Original motor parameters have been changed.
4. Motor bearings are worn or defective.

Action

1. Check the fan of **MAD** motors for proper functioning. Clean as required. Contact Bosch Rexroth Service in case of a failure.
Check the cooling system of **MAF** motors for proper functioning. Clean or rinse the cooling circuit as required. Contact the machine manufacturer in case of a failure of the cooling system.
2. Check whether the design of the drive meets the changed requirements. Do not continue operation in case of overload. Risk of damage!
3. Restore the original parameterization. Check whether the design of the drive complies with requirements if these have been changed.
4. Contact the machine manufacturer.

12.5.3 High Motor Temperature Values, but Normal Housing Temperature

State The diagnostic system of the controller shows exceptionally high values of the winding temperature on its display or via the application software. However, the temperature of the motor housing is normal.

Possible causes

1. Wire error or cable break in sensor line.
2. Diagnostic system defective.
3. Check whether the temperature sensor is wired and connected according to the connection diagram.
4. Failure of the winding temperature sensor (PTC).

Action

1. Check the diagnostic system of the controller or the control unit.
2. Check the resistance value of the temperature sensor using a multimeter.
 - Set the measuring device to resistance measurement mode.
 - Switch off the machine and wait until the discharge time has elapsed. Disconnect the temperature sensor from the controller and connect the wire pair to the measuring device (this also checks the sensor line). Check the values according to [fig. 9-20 "Characteristic curve of temperature measurement sensor KTY84-130 \(PTC\)"](#) on page 238.

12.5.4 Motor or Machine Table Generates Vibrations

State Vibrations can be heard or felt on the motor.

- | | |
|------------------------|---|
| Possible causes | <ol style="list-style-type: none"> 1. Driven machine elements are inadequately coupled or are damaged. 2. Motor bearings are worn or defective.
Available bearing or grease service life has elapsed. 3. Motor attachment has come loose. 4. The drive system is instable because of wrong technical control factors. |
| Action | <ol style="list-style-type: none"> 1. Contact the machine manufacturer. 2. Contact the machine manufacturer. 3. Check the mechanical connection. Do not reuse damaged parts. Contact the machine manufacturer. 4. Check the parameterization of the drive system (motor and encoder data). Observe the guidelines in the documentation of the controller. |

12.5.5 Specified Position Is not Reached

- | | |
|------------------------|---|
| State | The positioning command of the control is executed either inaccurately or not at all. Not failure display on controller or control unit. |
| Possible causes | <ol style="list-style-type: none"> 1. Faulty or defective wiring of the encoder cable. Pin assignment (encoder signals) in the cable or plug may be inverted. 2. Inadequate shielding of encoder cable against interference signals. 3. Incorrect parameterization of encoder data in controller. 4. Connection between motor and machine element has come loose. 5. Encoder defective. |
| Action | <ol style="list-style-type: none"> 1. Check whether the wiring complies with the machine connection diagram and check the cable for damage. 2. Check the shield. If necessary, increase the effective contact surfaces of the shield. 3. Correct the parameterization. Observe the commissioning log. 4. Check the mechanical connection. Do not reuse damaged parts. Contact the machine manufacturer. 5. The encoder must be replaced. Contact the machine manufacturer. |

12.6 Environmental Protection and Disposal

12.6.1 Environmental Protection

- | | | | | | |
|---|--|---------------------------|---------------|---|---|
| Production Processes | The products are made with energy- and resource-optimized production processes which allow re-using and recycling the resulting waste. We regularly try to replace pollutant-loaded raw materials and supplies by more environment-friendly alternatives. | | | | |
| No Release of Hazardous Substances | Our products do not contain any hazardous substances which may be released in the case of appropriate use. Normally, our products will not have any negative influences on the environment. | | | | |
| Significant Components | Basically, our products contain the following components: <table border="0" style="margin-left: 20px;"> <tr> <td style="vertical-align: top;">Electronic devices</td> <td style="vertical-align: top;">Motors</td> </tr> <tr> <td> <ul style="list-style-type: none"> • steel • aluminum • copper • synthetic materials • electronic components and modules </td> <td> <ul style="list-style-type: none"> • steel • aluminum • copper • brass • magnetic materials • electronic components and modules </td> </tr> </table> | Electronic devices | Motors | <ul style="list-style-type: none"> • steel • aluminum • copper • synthetic materials • electronic components and modules | <ul style="list-style-type: none"> • steel • aluminum • copper • brass • magnetic materials • electronic components and modules |
| Electronic devices | Motors | | | | |
| <ul style="list-style-type: none"> • steel • aluminum • copper • synthetic materials • electronic components and modules | <ul style="list-style-type: none"> • steel • aluminum • copper • brass • magnetic materials • electronic components and modules | | | | |

Operating of IndraDyn A Motors

12.6.2 Disposal

Return of Products

Our products can be returned to our premises free of charge for disposal. It is a precondition, however, that the products are free of oil, grease or other dirt. Furthermore, the products returned for disposal must not contain any undue foreign material or foreign components.

Send the products "free domicile" to the following address:

Bosch Rexroth AG
Electric Drives and Controls
Buergermeister-Dr.-Nebel-Strasse 2
97816 Lohr am Main, Germany

Packaging

The packaging materials consist of cardboard, wood and polystyrene. These materials can be recycled anywhere without any problem.

For ecological reasons, please refrain from returning the empty packages to us.

Batteries and Accumulators

Batteries and accumulators can be labeled with this symbol.



The symbol indicating "separate collection" for all batteries and accumulators is the crossed-out wheeled bin.

The end user within the EU is legally obligated to return used batteries. Outside the validity of the EU Directive 2006/66/EC keep the stipulated directives.

Used batteries can contain hazardous substances, which can harm the environment or the people's health when they are improper stored or disposed of.

After use, the batteries or accumulators contained in Rexroth products have to be properly disposed of according to the country-specific collection.

Recycling

Most of the products can be recycled due to their high content of metal. In order to recycle the metal in the best possible way, the products must be disassembled into individual modules.

Metals contained in electric and electronic modules can also be recycled by means of special separation processes.

Products made of plastics can contain flame retardants. These plastic parts are labeled according to EN ISO 1043. They have to be recycled separately or disposed of according to the valid legal requirements.

13 Motors for Potentially Explosive Atmospheres

13.1 General Information on Motors in Ex-px d Design (Type Code Option "M6" / "S6")

13.1.1 Introduction

IndraDyn A motors of this Ex-type design are not certified as explosion-protected parts but are merely prepared to be accepted as a part of an overall plant. Additionally required safety devices, such as they are described in the following chapter and the operator manual of the motors, must be set up by the user.

On delivery ex factory, each Ex-type motor is accompanied by an operator manual. This operator manual is an integral part of the product and must be kept by the user of the motors for the entire useful and service life of the product. When the product is passed on or sold, this manual must be passed on to each new owner or user.



In cases of doubt, the operator manual has priority over the information in this chapter. The user manual has the following order designation:

DOK-MOTOR*-IDYN*A*EXPD-IBxx-EN-P, MNR R911323996 (DE) or R911323997 (EN).

The operator manual of Ex-type motors contains detailed instructions on ...

- the mechanical attachment,
- the connection (electrical connection, coolant connection, purge gas connection)
- commissioning of the overall system,
- maintenance and disassembly.



If you do not have any operator manual in your language at your disposal before installing the motor, please contact your Bosch Rexroth sales partner.

DANGER

Improper handling may result in mortal danger and severe property damage. Explosion hazard!

Users may not install or commission Ex-type IndraDyn A motors without having read and understood the supplied operator manual and implemented the measures described therein.

Motors for Potentially Explosive Atmospheres

13.1.2 Device Group / Device Categories

According to Directive 94/9/EC, Rexroth IndraDyn A Ex-type motors are operating resources of

- device group II
 - device category 2G
 - device category 3G

and are suitable for use in the following potentially explosive atmospheres:

- zone 1
- zone 2

Device group II, device category 2G

Devices which are designed such that they can be operated in conformity with the parameters specified by the manufacturer while ensuring a high degree of safety. Devices of this category are intended for use in areas where it must be expected that an explosive atmosphere comprising dust-air mixtures occurs **occasionally**. The equipment-based explosion protection measures of this category ensure the required degree of safety, even in case of frequent device malfunctions or error conditions which must be usually expected.

Device group II, device category 3G

Devices which are designed such that they can be operated in conformity with the parameters specified by the manufacturer while ensuring a normal degree of safety. Devices of this category are intended for use in areas where it is **unlikely** that dust whirling up generates an explosive atmosphere and, if such an atmosphere is indeed generated, that it occurs **only rarely and for a short period**. Devices of this category ensure the required degree of safety during normal operation.

13.1.3 Zones of Potentially Explosive Atmospheres



The following information is based on EN 60079-14:2008 and on BGBl. 1996, part 1, page 1914. For more detailed information, please refer to this document.

Potentially explosive atmospheres are classified into the following zones according to the probability of the occurrence of an explosive atmosphere:

Zone 0 ... comprises areas with an explosive atmosphere consisting of a mixture of air and gases, vapors or mists or with such an atmosphere existing permanently, over a long period, or frequently.

Electrical operating resources may be used in zone 0 if they meet the requirements of EN 60079-11:2007 (intrinsic safety "i").

Zone 1 ... comprises areas where an explosive atmosphere consisting of gases, vapors or mists occurs occasionally.

Electrical operating resources may be used in zone 1 if they have been designed according to the requirements for zone 0 or according to one of the ignition protection types described in [fig. 13-2 "Ignition protection types" on page 293](#).

Zone 2 ... comprises areas where it is unlikely that an explosive atmosphere is induced by gases, vapors or mists and, if such an atmosphere is indeed occurring, that it occurs only rarely and for a short period.

Electrical operating resources may be used in zone 2 if they

- are designed according to the requirements for zone 0 or 1,
- are especially designed for zone 2,

Motors for Potentially Explosive Atmospheres

- meet the requirements of a recognized standard for industrial electrical operating resources and have hot surfaces that are not ignitable during undisturbed operation.

13.1.4 Device Groups, Ignition Protection Types and Temperature Classes

Electrical operating resources for potentially explosive atmospheres are subdivided into:

- Device groups**
- **Group I:** Electrical operating resources for underground parts of mines liable to be endangered by firedamp.
 - **Group II:** Electrical operating resources for all potentially explosive atmospheres, except for underground parts of mines liable to be endangered by firedamp.

The electrical operating resources of Group II can be further subdivided according to the properties of the explosive atmosphere for which they are intended.

As regards the ignition protection types explosion-proof enclosure "d" and intrinsic safety "i", electrical operating resources of group II are subdivided into IIA, IIB and IIC (EN 60079-0:2009, chapter 4.2).

Classification of gases and vapors

Explosion subgroup	Gases and vapors			
IIA	Ammonia Methane Ethane Propane	Ethyl alcohol Cyclohexane n-butane	Benzines in general Kerosine n-hexane	Acetaldehyde
IIB	City gas Acrylonitrile	Ethylene Ethylene oxide	Ethylene glycol Hydrogen sulfide	Ethyl ether
IIC	Hydrogen	Ethine (acetylen)	Carbon disulfide	

Fig. 13-1: Explosion subgroup gases and vapors

All ignition protection types require that operating resources of Group II be labeled subject to their maximum surface temperature according to [fig. 13-3 "Classification of the maximum surface temperatures of electrical operating resources of Group II"](#) on page 294.

Ignition protection types

Based on the ignition protection type, electrical operating resources are classified by their construction. Requirements are defined in special standards.

Ignition protection type	Labeling	Standard
Explosion-proof enclosure	Ex d	EN 60079-1
Pressurized enclosure	Ex p	EN 60079-2
Powder filling	Ex q	EN 60079-5
Oil immersion	Ex o	EN 60079-6
Increased safety	Ex e	EN 60079-7
Intrinsic safety	Ex i	EN 60079-11

Motors for Potentially Explosive Atmospheres

Ignition protection type	Labeling	Standard
Ignition protection type n	Ex n	EN 60079-15
Encapsulation	Ex m	EN 60079-18

Fig. 13-2: Ignition protection types

Electrical operating resources of these ignition protection types are certified by a neutral body based on a type test.

Temperature classes

Electrical operating resources of Group II must be labeled according to EN 60079-0:2009, chapter 5.3.2.2 and must

- (preferably) be assigned to a temperature class according to the following table, or
- be labeled with the particular maximum surface temperature, or
- if applicable, be limited to the exposure of a specific gas for which the operating resource is intended.

Temperature class	Maximum surface temperature [°C]
T1	450
T2	300
T3	200
T4	135
T5	100
T6	85

Fig. 13-3: Classification of the maximum surface temperatures of electrical operating resources of Group II

13.2 Appropriate Use

⚠ WARNING

Improper handling may result in mortal danger and severe property damage. Explosion hazard!

- IndraDyn A motors of this Ex-type design are not certified as explosion-protected devices but are merely prepared to be accepted as a part of an overall plant. The user has to set up additional safety devices. Please also observe the information provided in [chapter 13.6 "Additional Components" on page 299](#).
- To ensure explosion protection, do not use any purging devices other than those having an Ex protection class corresponding to the motor or a higher class.
- The values specified on the name plate ([fig. 13-4 "Ex-identification plate on Ex-type motors" on page 298](#)) for purge volume, purge gas, upstream pressure, overpressure, etc. must be ensured and monitored by the purging device.

Range of application

The motors described here (components for device group II, category 2G, Directive 94/9/EC, Annex II, Chapter 2.2.1) may only be used in environments in which

- gases, vapors or mists are **not likely to generate an explosive atmosphere**,

Motors for Potentially Explosive Atmospheres

- gases, vapors or mists can generate an explosive atmosphere only **occasionally**.

For this reason, the user has to design and manufacture the plant and the components such that ignition sources are avoided even in the event of frequently occurring device malfunctions or faulty operating states which must usually be expected.

13.3 Conditions of Use

13.3.1 General Information

Connection conditions The motors may only be operated with Bosch Rexroth drive controllers and IndraDrive connecting cables. Controllers or cables from other manufacturers are not allowed. Clamp-type terminals must be securely screwed into the terminal box. Because of the risk of sparking, plugs in potentially explosive atmospheres may only be disconnected or connected when they are de-energized.

Grounding Speed-controlled drive systems contain unavoidable leakage current discharging via the earth. For this reason, motors must be grounded according to EN 60079-0:2009, chapter 15.3 via the motor cable and a second separate ground conductor with a cross-section of **at least 4 mm²** (MAF225C-0150 with at least 25 mm²). Prior to commissioning, the protective conductor must be checked for proper connection and tight seating.



Incorporate regular checks of the protective conductor connectors into the machine maintenance schedule.

If the protective conductor in the motor cable and the second separate protective conductor on the motor housing are not connected or are interrupted by corrosion or other defects during their service life, the discharge current flows (as leakage current) over conducting housing parts. This must be prevented with the above-mentioned measures (Directive 94/9/EC, Annex II, chapters 1.2.3 and 1.3.3, 1.4).

Risk of corrosion Corrosion of the motor housing by aggressive materials (such as certain coolants, lubricants, cutting oils or salt mists) must be prevented.

Emergency stop Stored energies in the drive controller must be removed or isolated as quickly as possible when the **emergency stop device** is actuated to ensure that the risk or an effect into the danger zone is reduced in the event of a failure (Directive 94/9/EG, Annex II, chapter 1.6.2).

For example, this can be achieved as follows:

- Discharge of the energies via a DC bus short-circuit
- Isolation of the energies before they are transferred into the potentially explosive atmosphere by isolating the voltage of the lines and motors present in the potentially explosive atmosphere.

Other environmental factors Observe the following with regard to risks caused by external disturbances:

- Operation only within the specified ambient conditions
- Maximum vibration and impact loads
- Protection of protective conductor connections against dirt, corrosion, moisture and/or aggressive materials, etc.

Surface of the Motor Housing The housing paint of the motors consists of a black (RAL9005) 2K epoxy resin coating based on epoxy-polyamide resin in water.

Motors for Potentially Explosive Atmospheres

Overcoating the motors in ATEX design is not admissible in order to not to effect the surface properties (such as insulation resistance, electrostatic charge) adversely.

13.3.2 Internal Motor Brake (Optional)

The brake incorporated in the motor may only be used during **normal operation** and only for the drive-internal brake test. In this case, only low temperatures of $T < 100\text{ °C}$ occur and sparks are not generated because there is no critical surfacing of the brake pads.

Brake activation The voltage supply of the holding brake is to be designed such that the voltage available at the motor for releasing/applying the holding brake is sufficient even in the most unfavorable case during installation and operation (see also Rexroth IndraDrive Drive Systems with HMV01/02, HMS01/02, HMD01, HCS0203, Chapter "Project Planning of Control Voltage").



The switching voltage incoming at the motor is subject to the line length and the cable properties, e.g., conductor resistance.

- A minimum voltage of 22.8 V (24 V - 5 %) is recommended at the drive controller for ready-made Bosch Rexroth power cables up to 50 m in length.
- A minimum voltage of 24.7 V (26 V - 5 %) is recommended at the drive controller for ready-made Bosch Rexroth power cables more than 50 m in length.

If a fault occurs during operation, causing a voltage deviation, this fault must be detected and eliminated immediately. For example, the fault can be detected by a undervoltage monitoring unit.

Malfunction While the motor is under speed, the brake may only be actuated in the event of a **malfunction**, i.e., in the event of a fault in the machine, for example, to impede or prevent dangerous dropping of vertical axes, as a support in addition to other measures. In this case, sparks may be generated in the brake and increased temperatures may occur within the motor. Any such fault must be immediately eliminated by the operator.

Functional test Prior to commissioning and at periodical intervals during operation (for example, approx. every 8 hours), the brake must be tested for proper functioning in a suitable brake test. A defined torque is applied to the motor to check whether the brake has been completely released. Some drive controller types allow carrying out an integrated brake test by means of the Brake check command. For further information and data, please refer to the particular firmware functional descriptions relating to the drive controller.

13.4 Residual Risks

Protective equipment failure	In the event of a failure of the purging device and, at the same time, the monitoring unit for maintaining the safety measures, explosion protection is no longer ensured in an explosive atmosphere, therefore posing the risk of an explosion.
Overload	If the motor is overloaded, including cases where errors in the mechanical or electrical equipment of the machine cause such overloading, high temperatures may occur that result in explosion hazards.
Grounding and leakage currents	Variable-speed drive systems cause unavoidable leakage currents. If the protective conductor in the motor cable and the second separate protective conductor on the motor housing are not connected or are interrupted by corrosion or other defects during their service life, the discharge current flows (as leakage current) over conducting housing parts. This is associated with the risk of sparking at transition points and with explosion hazard if explosive materials are present. For this reason, checks of the proper condition of the two protective conductor connections must be carried out at regular intervals.
Material ageing	The time of action and penetration of explosive materials depend on the application. It depends on the ageing degree of the seals, on the mechanical attachment of the motor, the properties of the explosive materials and the average temperature occurring during the operating time as a result of the load cycles.

13.5 Selecting and Labeling Ex-type Motors

Selecting the motors	<p>Ex-type motors must be selected and ordered based on a predefined encoder type in the particular motor type code.</p> <p>Ex-type motors are defined in the motor type code by selecting the encoder option</p> <ul style="list-style-type: none">• M6• S6 <p>Ex-type motors are therefore labeled at the 18th digit of the type code. This label is applicable for the following motors:</p> <ul style="list-style-type: none">• MAD□□□□-□□□□-□□-□6-□□□□-□□-□□• MAF□□□□-□□□□-□□-□6-□□□□-□□-□□
Motor name plate	See fig. 10-1 "Example name plate MAF" on page 272.
Additional identification plate containing motor purging data	<p>In addition to the motor name plate, Ex-type motors also bear an additional identification plate. This identification plate is located on the side of the motor housing next to the motor name plate and shows</p> <ul style="list-style-type: none">• the classification of the motor according to ATEX,• important details for adjusting the motor purging device.

Motors for Potentially Explosive Atmospheres

Bosch Rexroth Electric Drives and Controls GmbH Bgm.-Dr.-Nebel-Straße 2, 97816 Lohr am Main, Germany	
 II 2G Ex px d IIB T3 Gb	TPS 05 ATEX 57401-1-X
⇒ ① Spülvolumen: ② zu verwendendes Spülgas: ③ Technik: ④ Minimaler Vordruck (Spülgas): ⑤ Mindestdurchfluss Vorspülung: ⑥ Minimale Vorspülzeit: ⑦ Minimaler Überdruck: ⑧ Maximaler Überdruck: ⑨ Maximale Leckverluste: ⑩ Max. Umgebungstemperatur:	6 Liter Instrumentenluft Ausgleich der Leckverluste 2 bar Überdruck 35 l/min 60 Sekunden pro Motor 1 mbar 23 mbar 10 l/min 0°C ≤ Ta ≤ +40°C

- ⇒ II Device group II, suitable for all potentially explosive atmospheres except for underground parts of mines liable to be endangered by firedamp
- ⇒ 2G Device category 2, device only suitable for potentially explosive atmospheres cause by occasionally occurring gas
- ⇒ Ex The European Standard for explosion protection has been applied
- ⇒ px Ignition protection type px means that potentially explosive atmospheres are kept away from the ignition source (EN 60079-2) in compliance with special requirements in the type test certificate
- ⇒ d Ignition protection type d means that any transmission of an explosion to the outside is excluded (EN 60079-1)
- ⇒ IIB Explosion subgroup for certain gases and vapors
- ⇒ T3 The max. allowed surface temperature is 155 °C (within and without of the housing)
- ⇒ Gb Device with a high safety level for use in potentially gas explosive atmospheres where there is no ignition risk during normal operation or in the event of foreseeable faults/malfunctions
- ⇒ TPS***-X Motor registration number. X = Special requirements are applicable because Bosch Rexroth does not deliver the related safety device (control unit for pressurized enclosure). The instructions in the operator manuals of the Ex-type motors for adjusting the control unit (e.g., minimum purging time, minimum pre-purging flow, ...) are mandatory.
- ① Purge volume: **MAD/MAF100 = 4 L; MAD/MAF130 = 6 L; MAD/MAF160 = 10 L; MAD/MAF180 = 15 L; MAD/MAF225 = 19 L**
- ② Purge gas to be used: Instrument air
- ③ Method: Compensation of leak losses
- ④ Minimum upstream pressure (purge gas): 2 bar overpressure
- ⑤ Minimum pre-purging flow: **MAD/MAF100 = 25 l/min; MAD/MAF130 = 35 l/min; MAD/MAF160 = 55 l/min; MAD/MAF180 = 80 l/min; MAD/MAF225 = 100 l/min**
- ⑥ Minimum pre-purge time: 60 seconds per motor
- ⑦ Minimum overpressure: 1 mbar
- ⑧ Maximum overpressure: 23 mbar
- ⑨ Maximum leak losses: 10 l/min
- ⑩ Max. surrounding air temperature: 0 °C ≤ Ta ≤ +40 °C

Fig. 13-4: Ex-identification plate on Ex-type motors



The minimum pre-purging flow volume is based on a required total tube length of 20 m. Longer tubes may require higher values. In this context, the details on the purge gas connection and the pre-purging time of the overall system given in the operator manual must be observed.

UR/cUR listing

The motors were presented to "Underwriters Laboratories Inc.®" and have been approved by this UL authority according to UL1004 and CSA22.2, No. 100. The corresponding mark is provided on the motor name plate.

Motors for Potentially Explosive Atmospheres

Declaration of conformity Declarations of conformity confirming the structure and the compliance with applicable EN standards and guidelines are available for the motors. For a copy of the Declaration of Conformity, please refer to the operator manual of the motors.

13.6 Additional Components

13.6.1 General Information

To allow operation of the motor as a part of an overall system in potentially explosive atmosphere, additional components are required. Components not available from Bosch Rexroth are referred to as additional components and must be provided by the manufacturer of the machine.

An overall system mainly consists of:

Bosch Rexroth components

- MAD or MAF motors in Ex-type design (type code encoder option S6 or M6)
- IndraDrive motor controller
- Connecting cable

Additional components to be provided by other manufacturers

- Purging device and monitoring unit with connection tubes, accepted as overall system and certified for the degree of protection required.
- For MAF motors: External cooling system (liquid cooling). Specifications can be found in the motor project planning manual.
- For MAD motors: External cooling system (fan). Specifications can be found in the motor project planning manual and in the following instructions.

13.6.2 Motor Fan

MAD motors for potentially explosive atmospheres must be cooled by forced ventilation during operation. We recommend to use a radial fan which must be attached outside of the potentially explosive atmosphere. It is not allowed to attach a fan directly to the motor in potentially explosive atmospheres. When calculating and selecting a suitable motor fan, please observe the instructions in the project planning manual on motor cooling.



The fan, air tube and necessary small connection parts (tube clamps, etc.) are not included in the Bosch Rexroth delivery.

Motors for Potentially Explosive Atmospheres

13.6.3 Ex-p Control Unit for Motor Purging

Ex-type IndraDyn A motors are merely a part of a drive system which only ensure appropriate explosion protection in connection with an Ex-p control unit for motor purging.

⚠ WARNING

Improper handling may result in mortal danger and severe property damage. Explosion hazard!

In potentially explosive atmospheres, the motor may only be commissioned as an overall system with a control unit for motor purging. The control unit must be classified and approved according to the same protection class as the motor or a higher one.



The control unit required for operating the motor in a potentially explosive atmosphere is not included in the Bosch Rexroth delivery and must be provided by the user.

The approval of the motors was given based on ignition protection type

- **Ex-d** (encoder housing)
- **Ex-px** (motor housing)

according to EN 60079-1:2007 and EN 60079-2:2007 with a control unit of type **Typs 07-3711-2213/1002** from

- **BARTEC GmbH**
Max-Eyth-Str. 16
97980 Bad Mergentheim, Germany
Phone +49 (0)7931 597-0
Fax +49 (0)7931 597 -119
E-mail: info@bartec.de
Postfach 1166, D-97961 Bad Mergentheim

Alternatively, it is also possible to use control units from other manufacturers for motor purging, e.g.:

Gönnheimer Elektronik GmbH

Gewerbegebiet Nachtweide
Dr.-Julius-Leber-Strasse 2
67433 Neustadt, Germany
Postfach 100507, D-67405 Neustadt
Phone +49 (0)6321 49919-0, Fax +49 (0)6321 49919-41



The manufacturer's instructions on selecting and commissioning the control unit should be observed as early as in the design phase of the drive system.

13.6.4 Connecting Cables



No other power cables than Bosch Rexroth power cables may be used to operate the motors in potentially explosive atmospheres.

Bosch Rexroth offers appropriately ready-made power cables for the motors. These cables are checked for conformity with directives and relevant DIN and EN standards. Use the following documentation for selecting the cables:

- **Rexroth Connection Cables IndraDrive and IndraDyn**
DOK-CONNEC-CABLE-*INDRV-CAxx-xx-P
Material number R911322948 (German)
Material number R911322949 (English)

13.7 Installing, Commissioning, Servicing and Dismounting Ex-type Motors

Motors for potentially explosive atmospheres may only be installed and commissioned by appropriately trained and instructed staff. As a minimum requirement, the instructions should cover the various ignition protection types and installation methods as well as pertinent rules, regulations and general principles on zone classification.

Before installing the motor, check whether the required data on the name plate of the motor, e.g.,

- device group and device category,
- explosion subgroup,
- maximum allowed surface temperature,

comply with the locally allowed conditions of use in potentially explosive atmospheres.

Before installing the motor, ensure that the ambient conditions at the place of use, e.g., surrounding air temperature, humidity and vibration and/or shock load, do not exceed the values allowed.

Check the components for visible damage. Defective components may not be mounted.



For more detailed information on

- the mechanical attachment,
- the connection (electrical connection, coolant connection, purge gas connection),
- commissioning,
- pre-purging time of the overall system,
- maintenance and disassembly

of the Ex-type motors, please refer to the following operator manual:

- **DOK-MOTOR*-IDYN*A*EXPD-IBxx-xx-P**
Material number R911323996 (DE) and R911323997 (EN)
-

14 Service and Support

Our service helpdesk at our headquarters in Lohr, Germany and our worldwide service will assist you with all kinds of enquiries. You can reach us **around the clock - even on weekend and on holidays**.

	Helpdesk	Service Hotline Worldwide
Phone	+49 (0) 9352 40 50 60	Outwith Germany please contact our sales/service office in your area first. For hotline numbers refer to the sales office addresses on the Internet.
Fax	+49 (0) 9352 40 49 41	
E-mail	service.svc@boschrexroth.de	
Internet	http://www.boschrexroth.com You will also find additional notes regarding service, maintenance (e.g. delivery addresses) and training.	

- Preparing Information** For quick and efficient help please have the following information ready:
- Detailed description of the fault and the circumstances
 - Information on the type plate of the affected products, especially type codes and serial numbers
 - Your phone, fax numbers and e-mail address so we can contact you in case of questions.

Index

A

Accessories.....	203
Gearboxes	205
Sealing air connection	203
Terminal box, thread reducing fitting	205
Accumulators.....	290
Additional components for Ex-type motors.....	299
Ambient air temperature.....	223
Application Guidelines.....	223

B

Batteries.....	290
Bearing.....	180
Bearing failure.....	260
Bearings.....	247
A-side fixed bearing, option "A"	247
High-speed bearing, option "H"	247
Reinforced bearing, option "V"	248
Standard bearing, option "N"	247
Wear	260
Bearing service life.....	260
Grease service life	261
Bevel gear pinions.....	259
Brake.....	296
Activation	296
Braking energy.....	238, 240

C

Cleaning.....	226, 231
Commissioning.....	281
Condition on delivery.....	271
Conditions of use for Ex-type motors.....	295
Connection methods.....	207
Coolant inlet	219
Coolant input pressure	222
Coolant outlet	219
Coolant port thread	220
Encoder connection	216
Flange socket	208
Holding brake	218
Inside tube diameter	221
Motor cooling	219
Power connection	208
Quick coupling	220
Temperature sensor	218
Contained substances	
see "Significant components"	289
Continuous current at standstill.....	31
Continuous torque at standstill.....	31
Coolant.....	234
Corrosion protection	234
Coolant additives.....	235
Ready-to-use cooling water	235
Water treatment kits	235

C

Coolant supply.....	286
Coolant supply temperature.....	29, 237
Cooling type.....	177
Cooling water treatment.....	236
Coupling.....	258
Cycle duration.....	29
Cylindrical roller bearing.....	247

D

Deep-groove ball bearing.....	247
Degree of protection.....	226
Derating.....	31
Device group / device categories.....	292
Device groups.....	293
Dimension drawings MAD100.....	127
Dimension drawings MAD130.....	133
Dimension drawings MAD160.....	139
Dimension drawings MAD180.....	148
Dimension drawings MAD225.....	154
Dimension drawings MAF100.....	157
Dimension drawings MAF130.....	161
Dimension drawings MAF160.....	165
Dimension drawings MAF180.....	169
Dimension drawings MAF225.....	174
Disassembly.....	282
Discharge capacity.....	28
Discharge time.....	282
Disposal.....	290
Drive elements	
Coupling	257
Gearboxes	257
Pinion	257
Pulley	257
Drive system.....	15
Duty cycle.....	27

E

Electrical connection.....	280
Electric drive system.....	15
Encoder.....	242
Accuracy	242
Compatibility	242
Encoder connection	243
Incremental	242
Interface	242
Environmental protection.....	289

F

Fan	
Minimum distance	231
Fault states.....	288
Feedback, see motor encoder.....	179
Flange assembly.....	278

Index

F

Flange socket, see connection methods.....	208
Foot assembly.....	278
Frame shape.....	227

G

Grease service life.....	261
Reduction factors	261

H

Handling.....	271
Hazardous substances.....	289
High-voltage test, see also Test.....	271
Holding brake.....	180, 296
Activation	296
Clamping	240
Electrically clamping	240
Electrically releasing	240
Maintenance	286
Resurfacing	286, 287
Holding brakes	
Danger warning	239
Humidity.....	224

I

Identification.....	271
Ignition protection type	
Temperature classes	294
Ignition protection types.....	293
Inappropriate use.....	14
Consequences, exclusion of liability	13
Installation.....	277
Installation altitude.....	223
Installation positions.....	227
Output shaft at bottom	229
Output shaft at top	229
Intended use	
Applications	13
Introduction	13
Prerequisites	13
Introduction to the product.....	9

K

key.....	180
Key speed.....	31
Keyway.....	180
Kinetic friction.....	248

L

labyrinth seal.....	246
Labyrinth seal	
Drain hole	246

M

Maintenance.....	283
Mass.....	29
Maximum current.....	28
Maximum power.....	28
Maximum speed.....	28, 31
Maximum torque.....	28
Mean speed.....	250
Moisture condensation.....	237
Motor assembly.....	279
Motor attachment.....	277
Motor bearings, see also Bearings.....	247
Motor cooling.....	230, 232
Coolant	234
Coolant supply temperature	237
Fan	230
Prewarning temperature	237
Shut-off temperature	237
Motor encoder.....	179
Motor encoder, see also Encoder.....	242
Motor fan.....	283
Motor frame length.....	177
Motor frame size.....	177
Motor name plate.....	272, 297
Additional identification plate	297
Motor paint	
Additional paint	229

N

Name plate.....	271
Number of pole pairs.....	29

O

Operating conditions.....	223
Operation.....	281
Operation modes.....	27
Oscillating quantity level.....	265
Output shaft.....	180
Imbalance / balancing	244
Keyway	244
Keyway, graduated	244
Keyway groove length	244
Plain shaft	244
Overdefined bearing.....	257

P

Packaging.....	290
PELV.....	20
Potentially explosive atmospheres.....	292
Power connection with flange socket.....	208
Power connection with terminal box.....	209
Power wire cross-section.....	28, 207
Pressure drop	
Constant for determining the pressure drop .	29
Production processes.....	289
Protective extra-low voltage.....	20

R

Radial fan..... 232
 Air flow rate 232
Radial forces..... 228, 248
Radial load..... 248
Radial shaft sealing ring..... 245
 Tightness 245
Rated current..... 28, 31
Rated power..... 28
Rated speed..... 28, 31
Rated torque..... 28
Recycling..... 290
Residual risks
 Ageing 297
 Grounding and leakage currents 297
 System overload 297
Return of products..... 290
Rotor moment of inertia..... 29

S

Safety..... 277
Safety instructions for electric drives and con-
tols..... 15
Selecting and labeling Ex-type motors..... 297
Shaft load..... 247
Shaft sealing ring..... 245
Shock..... 225
Shutdown..... 282
Significant components..... 289
Skew bevel driving pinions..... 259
Sound pressure level..... 29
Standards..... 11
Storage..... 273
Storage conditions..... 275
Strength..... 279
Support
 see Service Hotline 303

T

Technical data of MAD100..... 32
Technical data of MAD130..... 46

T

Technical data of MAD160..... 59
Technical data of MAD180..... 68
Technical data of MAD225..... 77
Technical data of MAF100..... 80
Technical data of MAF130..... 94
Technical data of MAF160..... 108
Technical data of MAF180..... 116
Technical data of MAF225..... 124
Terminal box, see connection methods..... 208
Test
 High-voltage test 271
 Insulation resistance 271
 Protective conductor 271
Test, at the customer's..... 271
Test, at the factory..... 271
Thermal time constant..... 29
Tightness..... 229
Torque constant..... 28
Transport..... 273
Transport conditions..... 274
Troubleshooting..... 287

U

Use, see intended use and see non-intended
use..... 13
Utilization factor..... 223

V

Vibration..... 224
Vibration behavior of attached parts..... 267
 Resonances 267
Vibration-damped attachments..... 224
Vibration-decoupled attachments..... 224

W

Winding code..... 177

Z

Zones of potentially explosive atmospheres..... 292

Notes

Bosch Rexroth AG
Electric Drives and Controls
P.O. Box 13 57
97803 Lohr, Germany
Bgm.-Dr.-Nebel-Str. 2
97816 Lohr, Germany
Tel. +49 (0)93 52-40-0
Fax +49 (0)93 52-48 85
www.boschrexroth.com/electrics



R911295781